

**EN\_IMPORTANT, RETAIN FOR FUTURE REFERENCE: READ CAREFULLY.**

**FR\_IMPORTANT: A LIRE ATTENTIVEMENT ET A CONSERVER POUR VOUS Y REFRERER ULTERIEUREMENT**

**ES\_IMPORTANTE, LEA DETENIDAMENTE Y GUARDE PARA FUTURAS REFERENCIAS.**

**PT\_IMPORTANTE, GUARDE PARA FUTURA REFERÊNCIA, LEIA ATENTAMENTE.**

**DE\_WICHTIG! SORFGFÄLTIG LESEN UND FÜR SPÄTERES NACHSCHLAGEN AUFBEWAHREN.**

**IT\_IMPORTANTE, LEGGERE E CONSERVARE QUESTO MANUALE D'ISTRUZIONE PER UN USO FUTURO.**

## **EN Operation Instructions**

---

- Please confirm that all components are present before beginning assembly.
- Place all parts on a clean and smooth surface to prevent any damage.
- Do not fully tighten any screws until all screws have been initially tightened. This could cause the frame to warp.
- If wobbling persists or screw holes fail to align, loosen the screws and tighten them sequentially.

## **FR Instructions pratiques**

---

- Avant de commencer l'assemblage, veuillez confirmer que tous les composants sont présents.
- Placez toutes les pièces sur une surface propre et lisse de manière à éviter tout dommage.
- Ne serrez complètement aucune vis tant que toutes les vis n'ont pas été serrées initialement. Cela pourrait déformer le cadre.
- Si des oscillations persistent ou si les trous de vis ne s'alignent pas, desserrez les vis et serrez-les séquentiellement.

## **ES Instrucciones de operación**

---

- Por favor, confirme que todos los componentes están presentes antes de comenzar el ensamblaje.
- Coloque todas las piezas sobre una superficie limpia y lisa para evitar daños.
- No apriete completamente ningún tornillo hasta que todos los tornillos hayan sido apretados inicialmente. Esto podría deformar el armazón.
- Si persisten balanceos o los orificios de los tornillos no se alinean, afloje los tornillos y apriéte-los secuencialmente.

## **PT Instruções de funcionamento**

---

- Por favor, confirme que todos os componentes estão presentes antes de começar a montagem.
- Coloque todas as peças numa superfície limpa e lisa para evitar danos.
- Não aperte completamente nenhum parafuso até que todos os parafusos tenham sido apertados inicialmente. Isso pode deformar a estrutura.
- Se houver oscilações persistentes ou os furos dos parafusos não se alinharem, afrouxe os parafusos e aperte-os sequencialmente.

## **DE Betriebsanleitung**

---

- Bitte bestätigen Sie, dass alle Komponenten vor Beginn der Montage vorhanden sind.
- Legen Sie alle Teile auf eine saubere und ebene Fläche, um Beschädigungen zu vermeiden.
- Ziehen Sie keine Schrauben vollständig an, bis alle Schrauben zunächst angezogen wurden. Dies könnte den Rahmen verziehen.
- Falls Wackeln anhält oder Schraubenlöcher nicht ausgerichtet sind, lockern Sie die Schrauben und ziehen Sie sie nacheinander an.

## **IT Istruzioni per l'uso**

---

- Prima di iniziare l'assemblaggio, confermare che tutti i componenti siano presenti.
- Posiziona tutte le parti su una superficie pulita e liscia per evitare danni.
- Non stringere completamente alcuna vite finché tutte le viti non sono state avvitate inizialmente. Ciò potrebbe deformare il telaio.
- Se persistono oscillazioni o i fori delle viti non si allineano, allentare le viti e stringerle sequenzialmente.

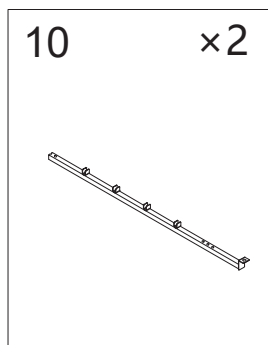
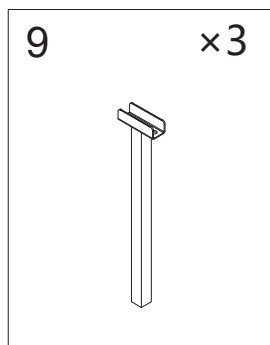
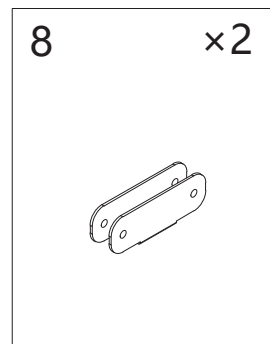
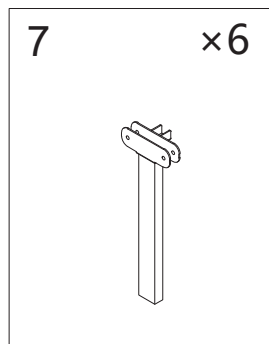
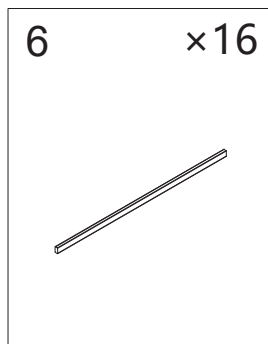
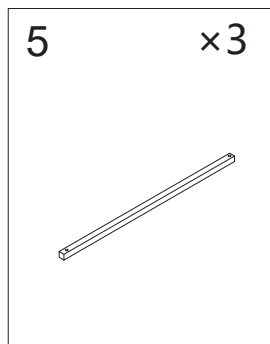
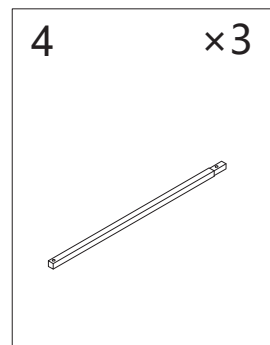
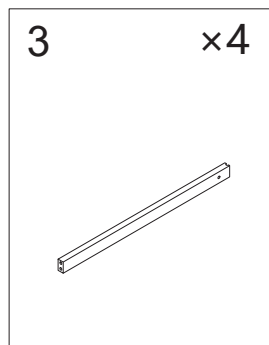
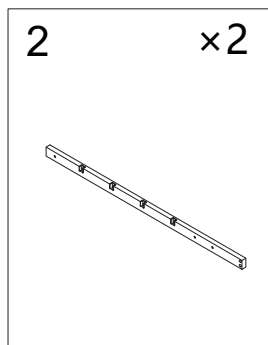
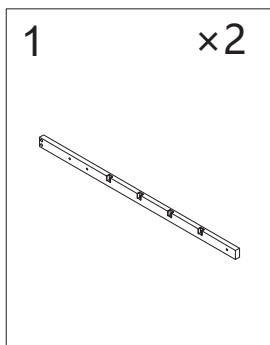

**A**      **×28**  
+2(spare)

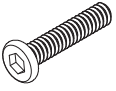

**M6×35**

**B**      **×3**  
+1(spare)

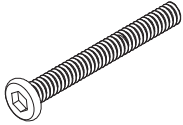

**M6×50**

**C**      **×8**  
+1(spare)

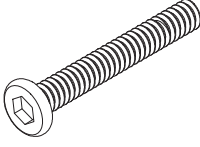

**M8×40**

**D**      **×2**  
+1(spare)

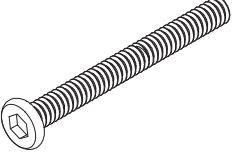

**M8×55**

**E**      **×22**  
+2(spare)



**M6×35**

**F**      **×1**

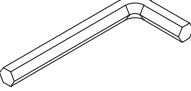

**S5**

**G**      **×1**



**16mm**

**H**      **×4**

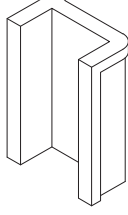

**Pre-installed**

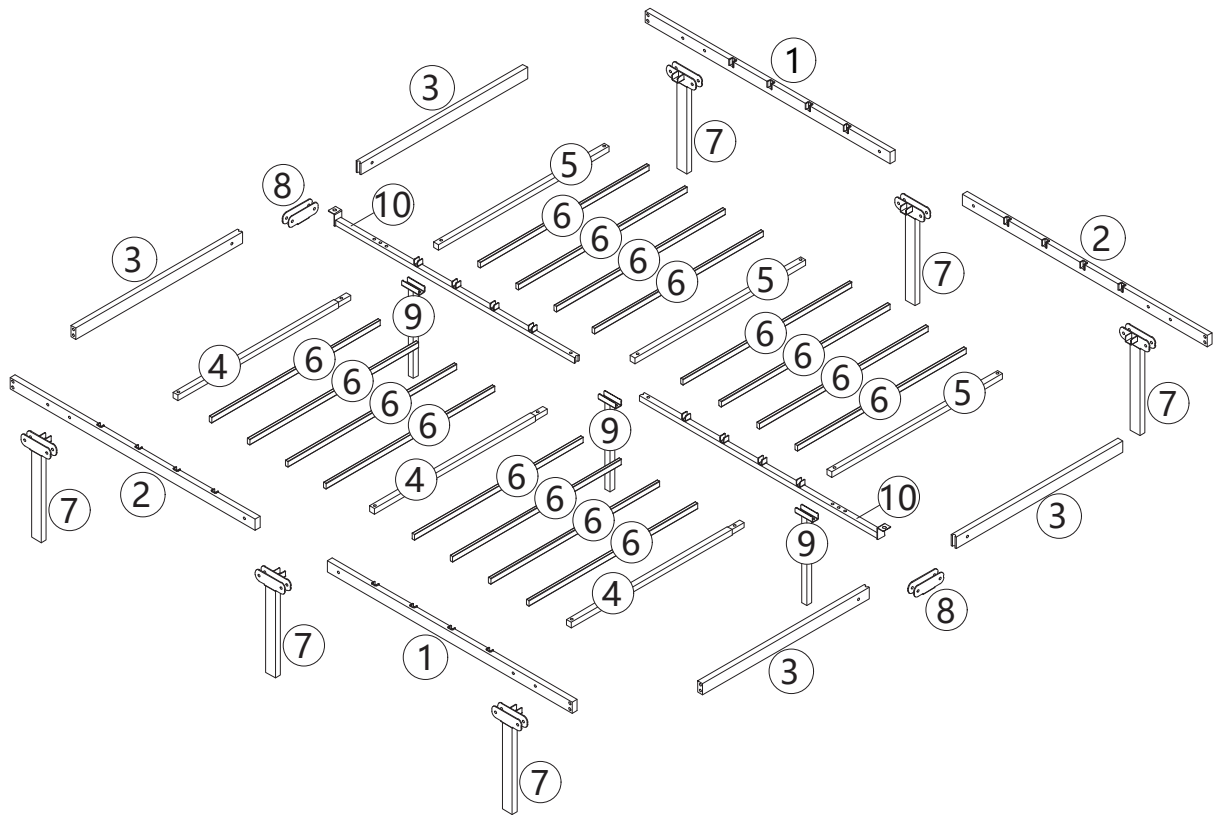



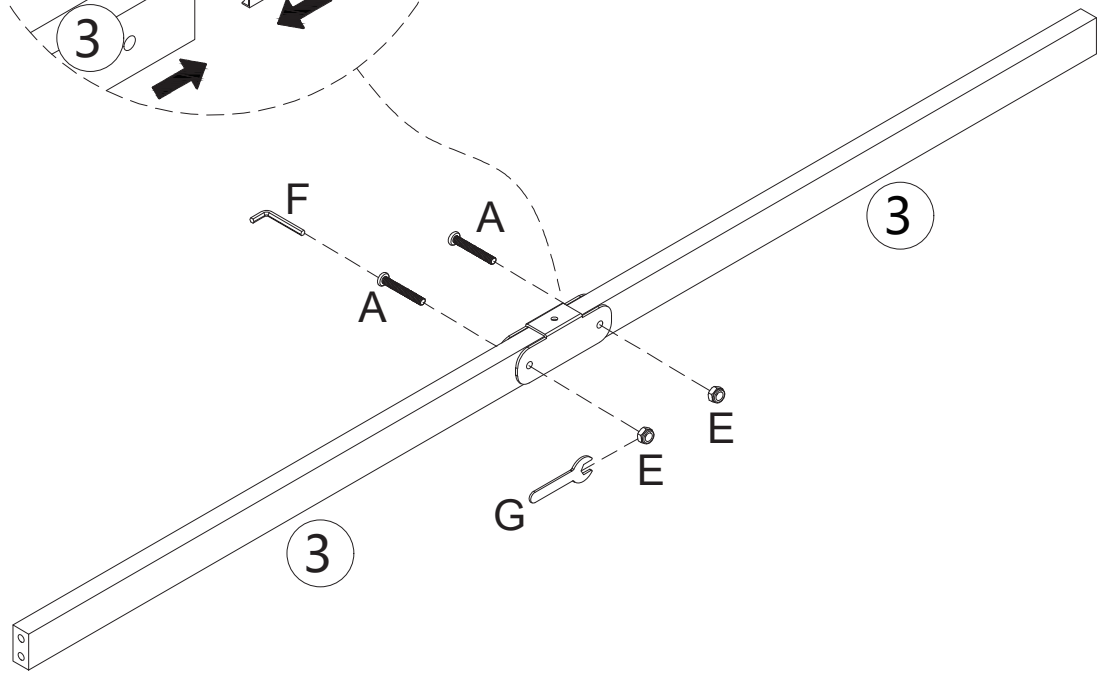
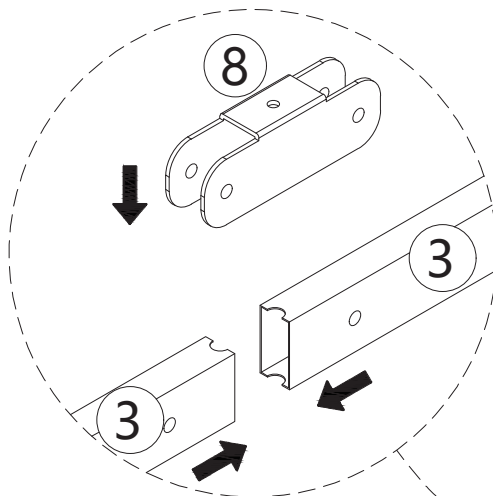
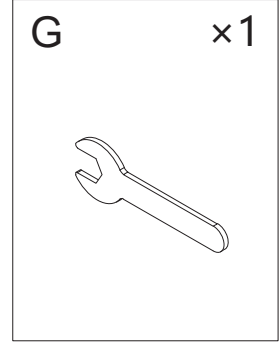
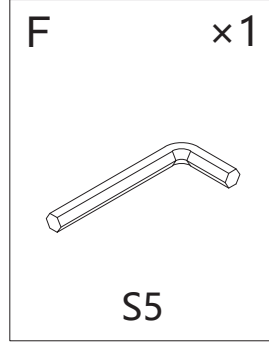
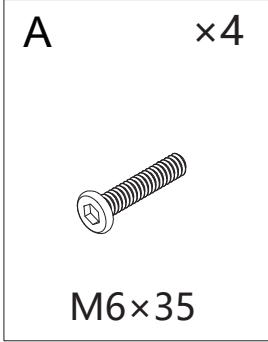

×2

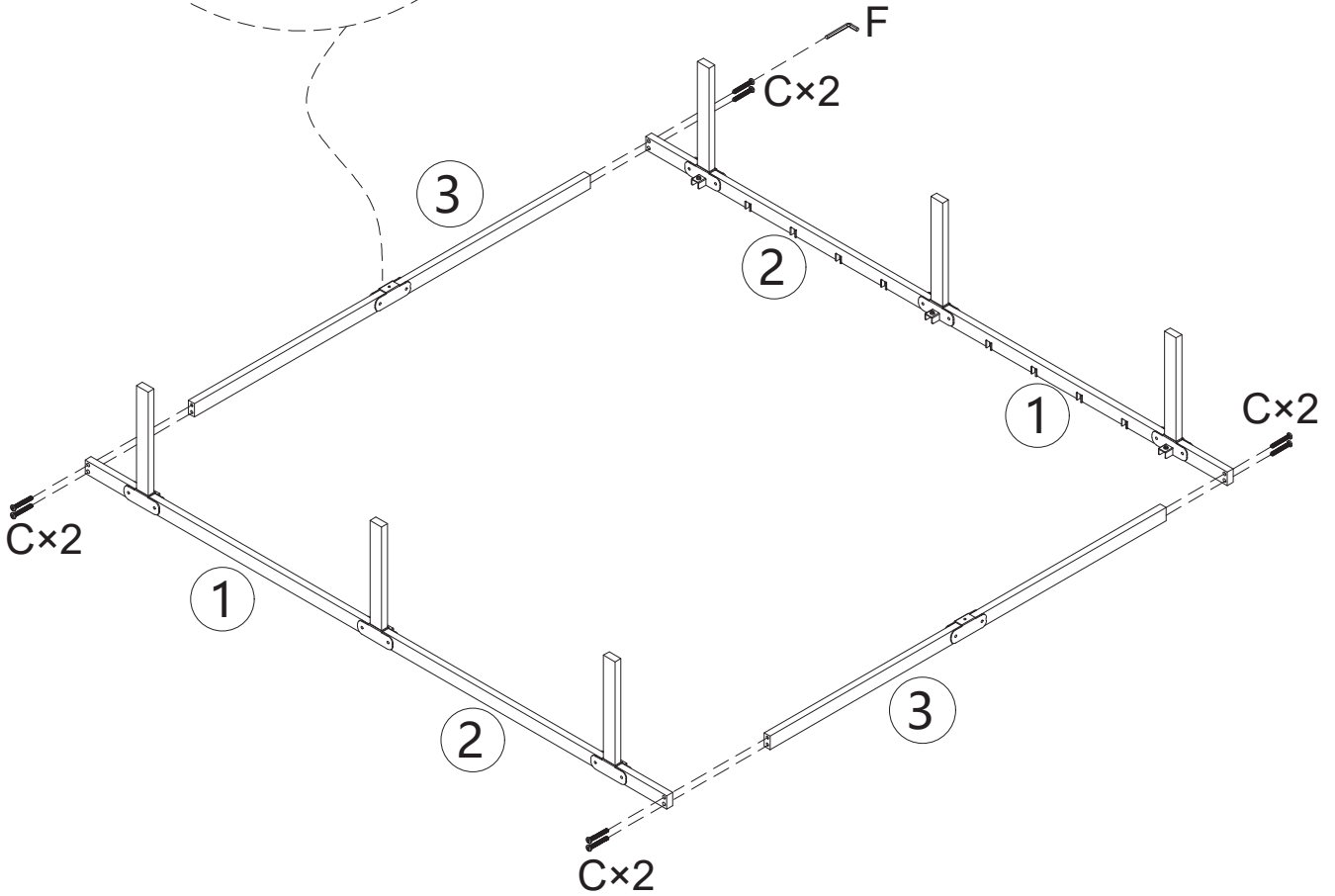
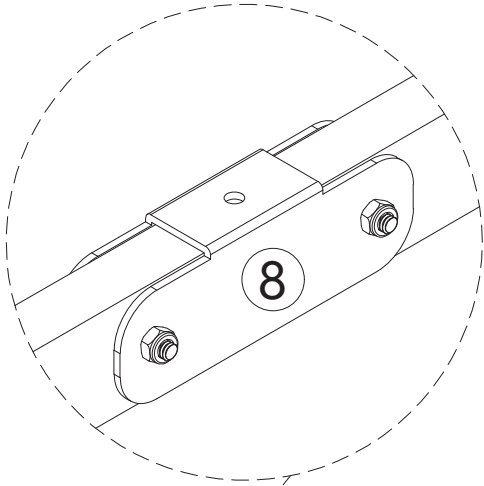
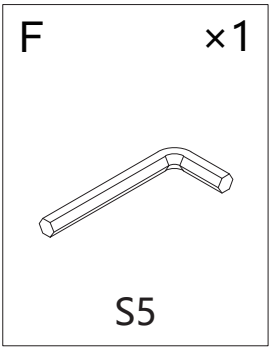
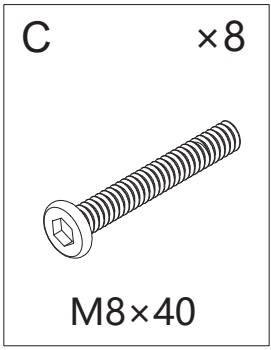

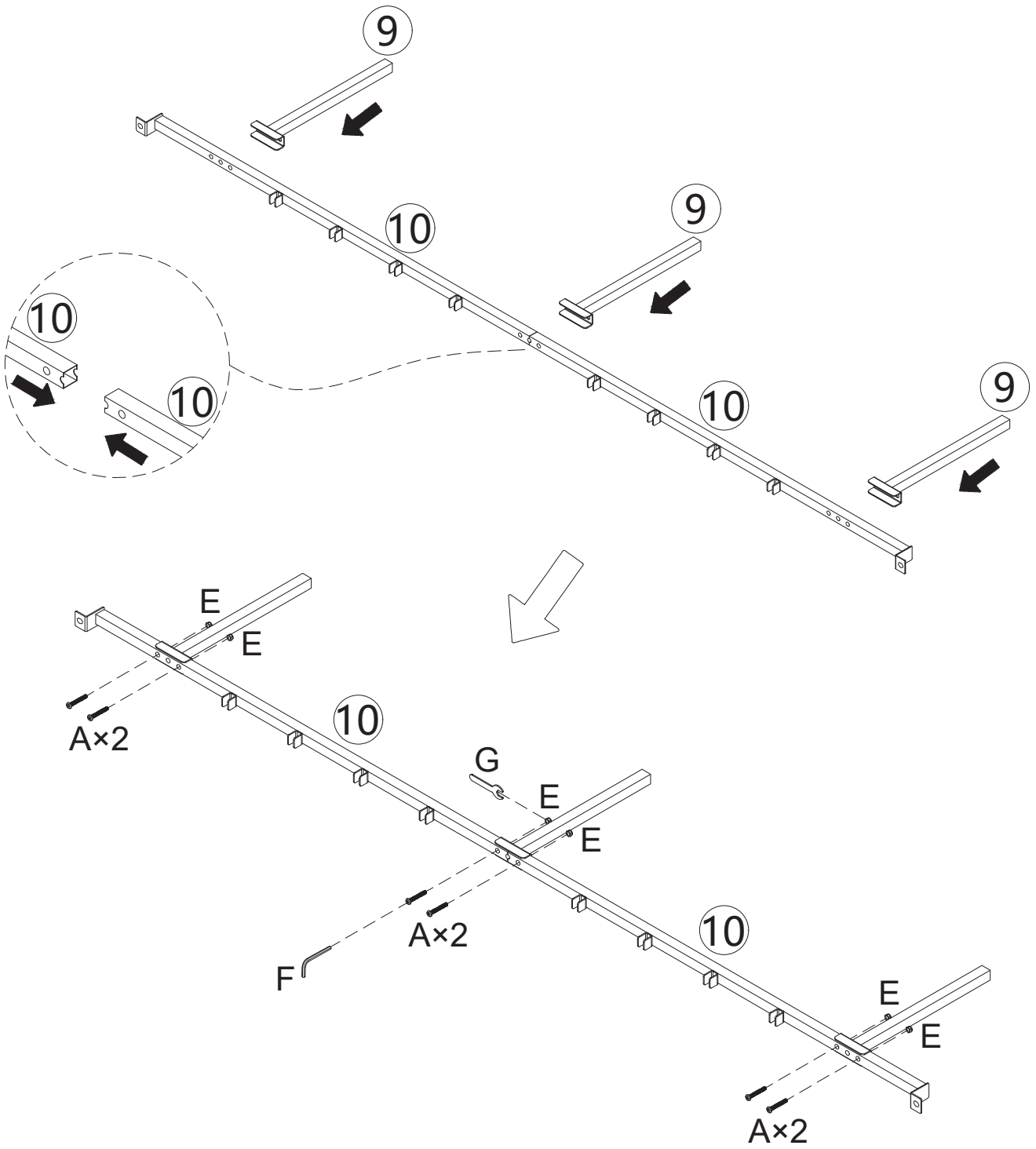
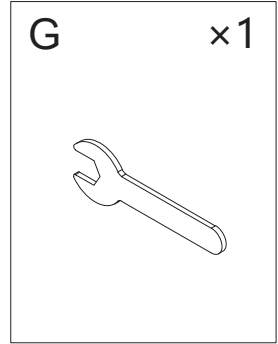
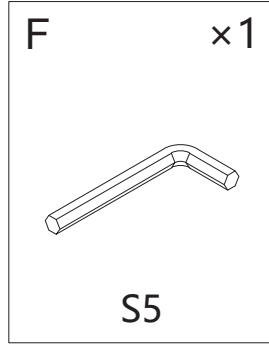
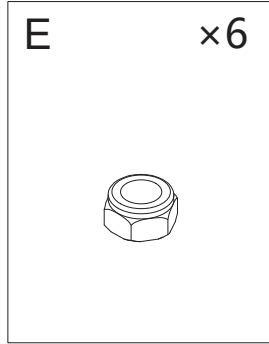
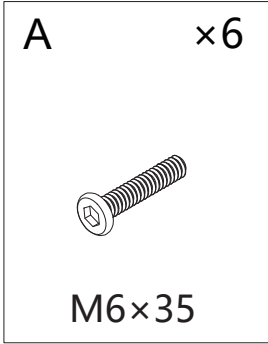

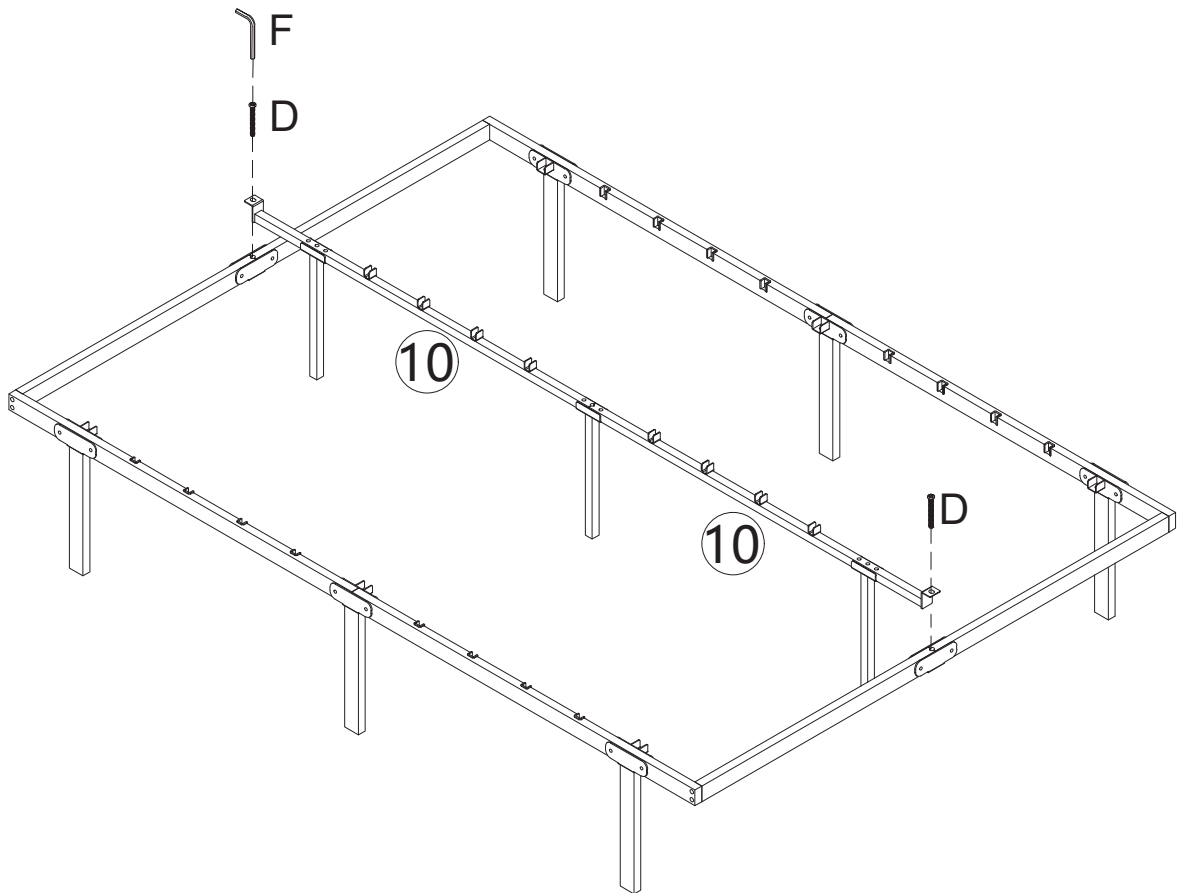
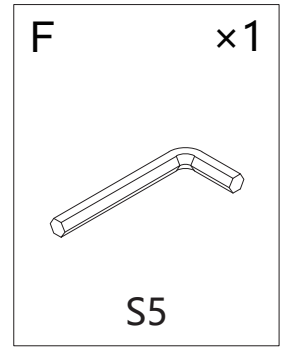
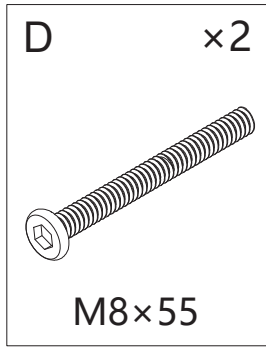

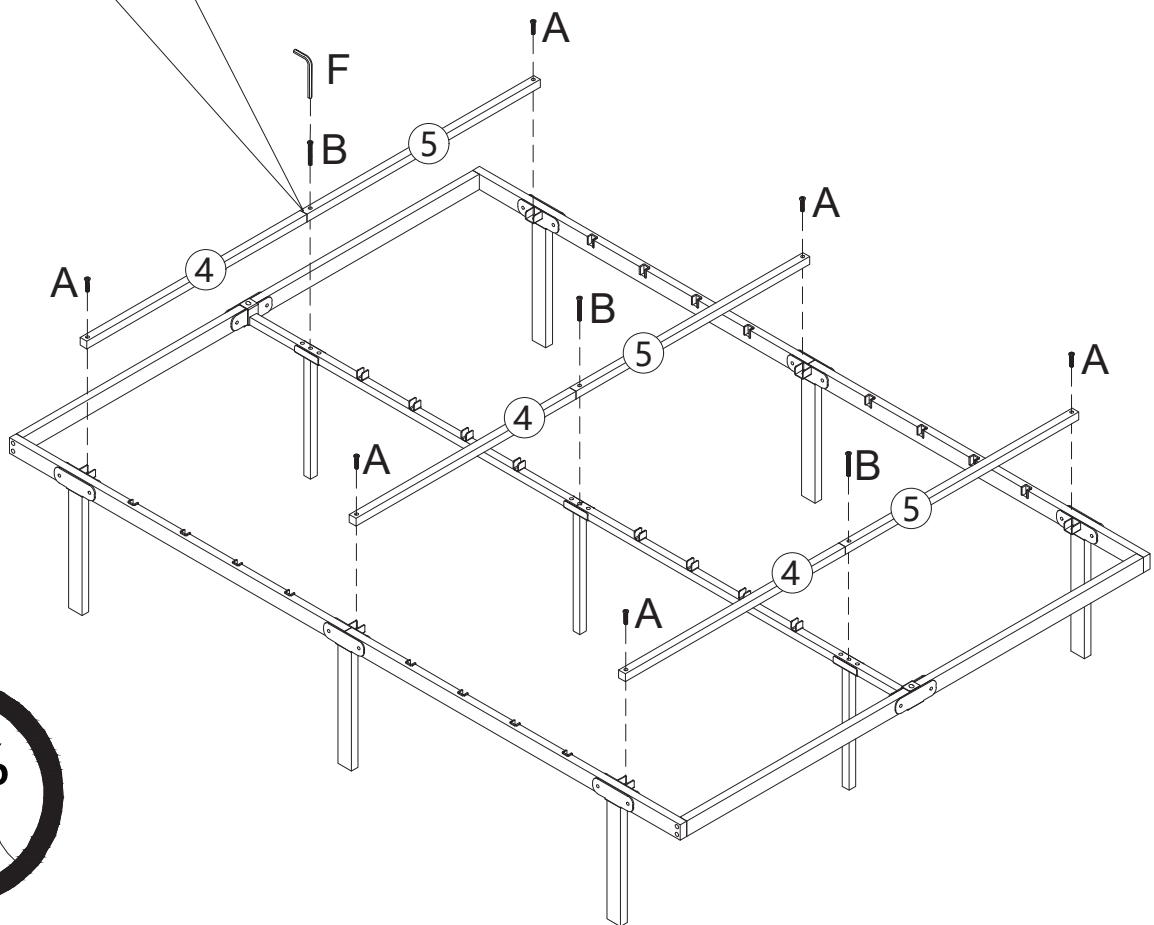
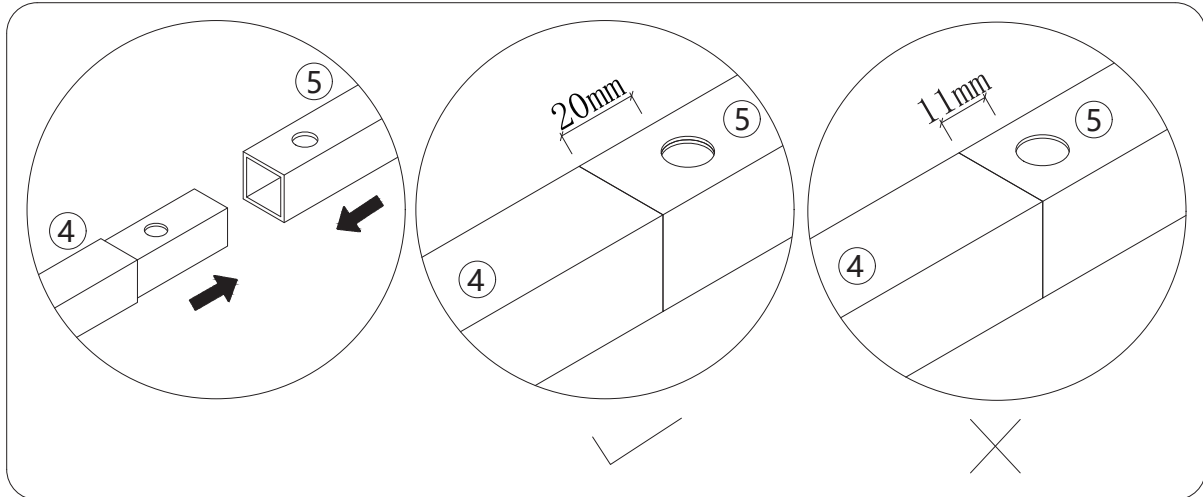
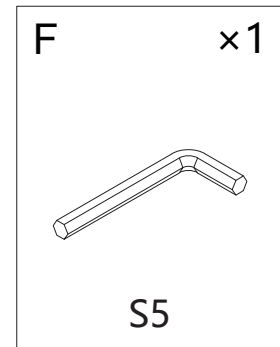
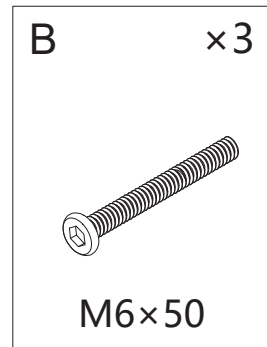
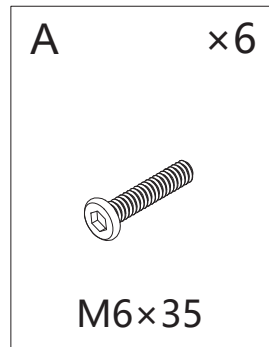

**EN:** Do not tighten bolts fully until all parts are connected!

**FR:** Ne serrez pas les boulons à fond tant que toutes les pièces ne sont pas connectées!

**ES:** No apriete los tornillos completamente hasta que todas las partes están conectadas!

**PT:** Não aperte totalmente os parafusos até que todas as partes estejam conectadas!

**DE:** Ziehen Sie die Schrauben erst fest an, wenn alle Teile verbunden sind!

**IT:** Non serrare completamente i bulloni fino a tutte le parti non sono ancora collegate!

**EN:** After installing Component No. 6, tighten all screws to ensure stability and prevent loosening during use.

**FR:** Après avoir installé le composant n° 6, serrez toutes les vis pour assurer la stabilité et éviter tout desserrage en cours d'utilisation.

**ES:** Después de instalar el componente n° 6, apriete todos los tornillos para garantizar la estabilidad y evitar que se aflojen durante el uso.

**PT:** Após instalar o componente n° 6, aperte todos os parafusos para garantir a estabilidade e evitar afrouxamento durante o uso.

**DE:** Ziehen Sie nach dem Einbau des Bauteils Nr. 6 alle Schrauben fest, um Stabilität zu gewährleisten und ein Lösen während des Betriebs zu verhindern.

**IT:** Dopo aver installato il componente n. 6, serrare tutte le viti per garantire stabilità ed evitare allentamenti durante l'uso.

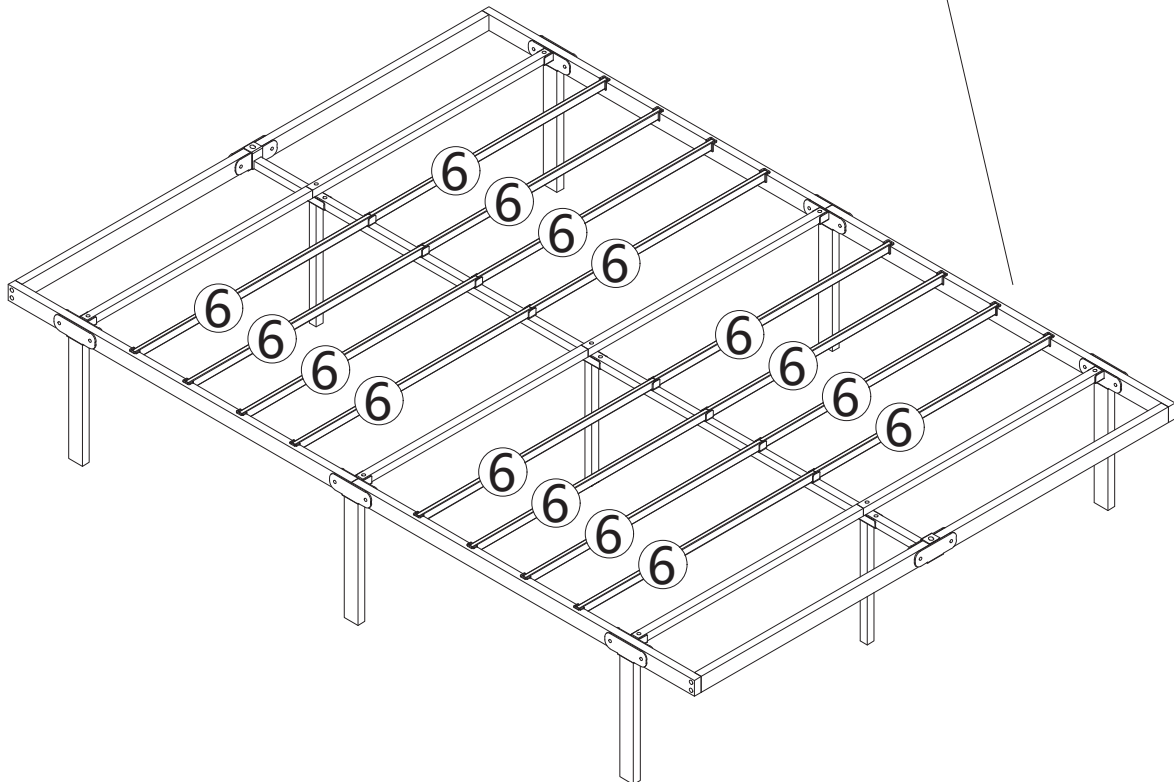
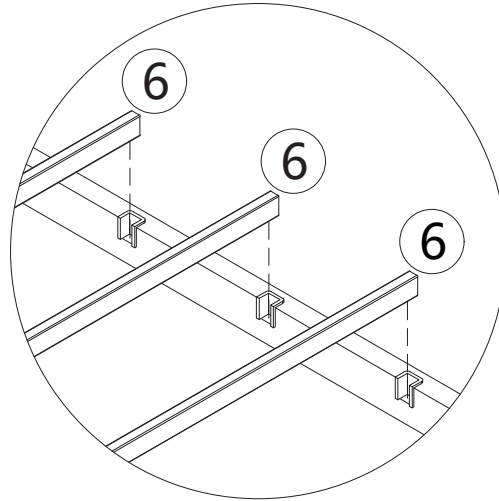
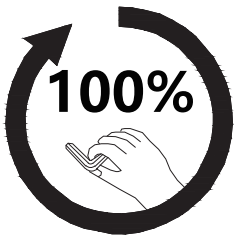

If you have any questions, please contact our customer care center, Our contact details are below:

**US**

 001-877-644-9366

 customerservice@aosom.com

Imported by Aosom LLC  
27150 SW Kinsman Rd Wilsonville, OR 97070 USA  
MADE IN CHINA

If you have any questions, please contact our customer care center, Our contact details are below:

**CA**

 416-792-6088

 customerservice@aosom.ca

Imported by Aosom Canada Inc.  
7270 Woodbine Avenue, Unit 307, Markham,  
Ontario Canada L3R 4B9  
MADE IN CHINA

Si vous avez la moindre question, veuillez contacter notre centre d'assistance à la clientèle, Nos coordonnées sont les suivantes:

 416-792-6088

 customerservice@aosom.ca

Importé par Aosom Canada Inc.  
7270 Woodbine Avenue, unité 307,  
Markham, Ontario Canada L3R 4B9  
FABRIQUÉ EN CHINE

If you have any questions, please contact our customer care center, Our contact details are below:

**UK**

 0044-800-240-4004

 enquiries@mhstar.co.uk

IMPORTER ADDRESS:  
MH STAR UK Ltd  
1 Northampton Cross Logistics Park  
Northampton Cross Road  
Northampton  
NN4 9FH  
MADE IN CHINA

Si vous avez la moindre question, veuillez contacter notre centre d'assistance à la clientèle, Nos coordonnées sont les suivantes:

**FR**

 0033-1-84166106

 aosom@mhfrance.fr

Importé par/Fabricant/REP:  
MH FRANCE  
2 Rue Maurice Hartmann  
92130 Issy Les Moulineaux  
France  
FABRIQUÉ EN CHINE

Wenn Sie Fragen haben, wenden Sie sich bitte an unser Kundendienstzentrum, Unsere Kontaktdaten stehen unten:

**DE**

 +49 40 87408465

 service@aosom.de

ADRESSE DES IMPORTEURE/Hersteller/REP:  
MH Handel GmbH  
Wendenstraße 309  
D-20537 Hamburg  
Germany  
IN CHINA HERGESTELLT

In caso di dubbio, si prega di contattare il nostro centro assistenza clienti, I nostri dettagli di contatto sono di seguito:

**IT**

 0039-0249471447

 clienti@aosom.it

IMPORTATO DA/Produttore/REP:  
AOSOM Italy srl  
Centro Direzionale Milanofiori  
Strada 1 Palazzo F1  
20057 Assago (MI)  
P.I.: 08567220960  
FATTO IN CINA

Si tiene alguna pregunta, comuníquese con nuestro Centro de Atención al Cliente, Nuestros datos de contacto son los siguientes:

**ES**

 0034-931294512

 atencioncliente@aosom.es

IMPORTADOR/Fabricante/REP:  
SPANISH AOSOM, S.L.  
C/ROC GROS, N°15.08550, ELS HOSTALETS DE  
BALENYÀ, SPAIN.  
B66295775  
HECHO EN CHINA

Se tiver alguma dúvida, por favor contacte o nosso Centro de Atendimento ao Cliente, Os nossos dados de contacto são os seguintes:

 0034-931294512

 info@aosom.pt.

IMPORTADOR/Fabricante/REP:  
SPANISH AOSOM, S.L.  
C.ROC GROS N.15, 08550. ELS HOSTALETS DE  
BALENYÀ  
FEITO NA CHINA



**FR**

**DONNEZ  
OU  
RECYCLEZ**



ASSOCIATION

OU



LIVRAISON

OU



DÉCHÈTERIE

Adresses sur [quefairedemesdechets.fr](http://quefairedemesdechets.fr)