

EN_IMPORTANT, RETAIN FOR FUTURE REFERENCE: READ CAREFULLY.

FR_IMPORTANT: A LIRE ATTENTIVEMENT ET A CONSERVER POUR VOUS Y REFRERER ULTERIEUREMENT

ES_IMPORTANTE, LEA DETENIDAMENTE Y GUARDE PARA FUTURAS REFERENCIAS.

PT_IMPORTANTE, GUARDE PARA FUTURA REFERÊNCIA, LEIA ATENTAMENTE.

DE_WICHTIG! SORFGFÄLTIG LESEN UND FÜR SPÄTERES NACHSCHLAGEN AUFBEWAHREN.

IT_IMPORTANTE, LEGGERE E CONSERVARE QUESTO MANUALE D'ISTRUZIONE PER UN USO FUTURO.

EN INTENDED USE IN OFFICE OR HOME

ABOUT CARE AND MAINTENANCE OF TABLE :

1. To prevent the table from being scratched by hard objects, do not let metal objects break the surface of the table and leave bruise marks.
2. Do not let the heat source has been baking, away from the source of fire. The surface should be fully considered to prevent dry cracking and deformation.
3. When in use, pay attention to the placement in a stable environment, otherwise there will be deformation.
4. Prevent direct sunlight, can use gauze to prevent sunlight, so not only does not affect day lighting, but also can maintain the desk.
5. To check the desk, regularly clean up, remove the dust and corrosive gas and liquid, to prevent the desk. Corrosion affects the whole integrity of the table.
6. When using water to wipe the desktop, to wipe it clean, do not leave moisture on the desktop.
7. When cleaning to use a clean soft cloth, do not be too hard to wipe.

FR UTILISATION PRÉVUE POUR LE BUREAU OU LA MAISON

À PROPOS DE L'ENTRETIEN ET DE LA MAINTENANCE DE LA TABLE :

1. Pour éviter que la table ne soit rayée par des objets durs, ne laissez pas d'objets métalliques briser la surface de la table et laisser des marques d'ecchymoses.
2. Ne laissez pas la source de chaleur a été la cuisson, loin de la source de feu. La surface doit être entièrement considérée pour éviter les fissures sèches et les déformations.
3. Lors de l'utilisation, assurez-vous que la table soit placée dans un environnement stable, sinon il y aura des déformations.
4. Empêcher la lumière directe du soleil, vous pouvez utiliser une gaze pour protéger le bureau de la lumière directe du soleil, de sorte que non seulement l'éclairage de jour ne soit pas affecté, mais aussi que la table soit préservée.
5. Inspecter régulièrement la table, nettoyer et enlever la poussière ainsi que les matières corrosives (gaz et liquides) afin de prévenir la corrosion de la table.
La corrosion affecte l'intégrité entière de la table.
6. Lorsque vous utilisez de l'eau pour essuyer la table, nettoyez-la soigneusement, ne laissez pas de traces d'humidité sur la table.
7. Lorsque vous nettoyez le la table, utilisez un chiffon doux et propre, sans trop forcer.

DE VORGESEHENE VERWENDUNG IM BÜRO ODER ZU HAUSE

ZUR PFLEGE UND WARTUNG DES TISCHES :

1. Um zu verhindern, dass der Tisch durch harte Gegenstände zerkratzt wird, vermeiden Sie, dass Metallgegenstände die Oberfläche des Tisches beschädigen und blaue Flecken hinterlassen.
2. Entfernen Sie die Wärmequelle für das Backen nicht von der Feuerquelle. Die Oberfläche sollte vollständig berücksichtigt werden, um Trockenrisse und Verformungen zu verhindern.
3. Wenn in Gebrauch, achten Sie auf die Aufstellung in einer stabilen Umgebung, sonst gibt es Verformungen.
4. Verhindern Sie direktes Sonnenlicht, Sie können Gaze verwenden, um Sonnenlicht zu verhindern, so dass nicht nur die Tagesbeleuchtung nicht beeinträchtigt wird, sondern auch der Schreibtisch erhalten werden kann.
5. Den Schreibtisch prüfen, regelmäßig aufräumen, den Staub und korrosives Gas und Flüssigkeit entfernen, um den Schreibtisch zu schützen. Korrosion beeinträchtigt die gesamte Integrität des Tisches.
6. Wenn Sie Wasser verwenden, um den Schreibtisch zu wischen, um ihn sauber zu wischen, hinterlassen Sie keine Feuchtigkeit auf dem Schreibtisch.
7. Bei der Reinigung ein sauberes, weiches Tuch verwenden, nicht zu hart wischen.

ES _ PARA USARSE EN OFICINA Y HOGAR

CUIDADO Y MANTENIMIENTO DE LA MESA:

1. Tenga en cuenta de que los objetos duros metálicos pueden romper la superficie de la mesa y dejar marcas de magulladuras.
2. No ponga el producto cerca de la fuente de calor, y manténgalo lejos de la fuente de fuego. De lo contrario, puede producir grietas y deformaciones en la superficie.
3. Cuando no la utiliza, colóquela en un lugar estable, para evitar la deformación.
4. Puede usar una gasa para protegerla de la luz solar directa, lo cual no afecta la iluminación diurna, mientras tanto puede ofrecer protección a la mesa.
5. Regularmente revise y limpie la mesa, eliminando el polvo y las materias corrosivas, para proteger la mesa. Las materias corrosivas pueden afectar la integridad de la mesa.
6. Después de limpiar la mesa con agua, tiene que secarla completamente. Tenga cuidado de no dejar humedad en la mesa.
7. Limpie la mesa con un paño suave y limpio, sin ejercer mucha fuerza.

PT _ Uso previsto em escritório ou em casa

SOBRE CUIDADOS E MANUTENÇÃO DE MESA:

1. Para evitar arranhões na mesa, não permita que objetos metálicos quebrem a superfície da mesa e deixem marcas de contusão.
2. Não exponha a mesa ao calor intenso ou fontes de fogo. A superfície deve ser totalmente considerada para evitar rachaduras secas e deformações.
3. Ao usar, preste atenção ao local onde é colocada em um ambiente estável, caso contrário, pode haver deformação.
4. Evite a luz solar direta e use gaze para evitar a luz solar, para que não afete a iluminação diurna e também possa manter a mesa.
5. Verifique a mesa regularmente, limpe-a e remova poeira, gás corrosivo e líquidos para evitar a corrosão que afeta toda a integridade da mesa.
6. Ao usar água para limpar a mesa, limpe-a completamente e não deixe umidade na mesa.
7. Ao limpar, use um pano macio e limpo e não limpe com força excessiva.

IT _ DESTINAZIONE D'USO IN UFFICIO O A CASA

CURA E MANUTENZIONE DELLA SCRIVANIA:

1. Per evitare che la scrivania venga graffiata da oggetti duri, non lasciare che gli oggetti metallici rompano la superficie dell scrivania e lascino le tracce.
2. Non permette che la fonte di calore la inforni, tenerla lontana dalla fonte di fuoco. La superficie dovrebbe essere considerata completamente per evitare crepe e deformazioni secche.
3. Quando è in uso, prestare attenzione al posizionamento in un ambiente stabile, altrimenti si verificherà una deformazione.
4. Prevenire la luce solare diretta. Si può utilizzare una garza per prevenire la luce solare in modo che non influisca sull'illuminazione diurna, ma possa anche mantenere la scrivania.
5. Controllare la scrivania, pulire regolarmente, rimuovere la polvere e il gas e il liquido corrosivi per mantenere che la scrivania. La corrosione influenza l'intera integrità della scrivania.
6. Quando si utilizza l'acqua per pulire la superficie, non lasciare umidità sulla superficie.
7. Quando la pulisci, utilizza un panno morbido pulito, non pulirla con forza troppo forte.

IF HAVE THIS ACCESSORY

NOTE DIFFERENT MODELS

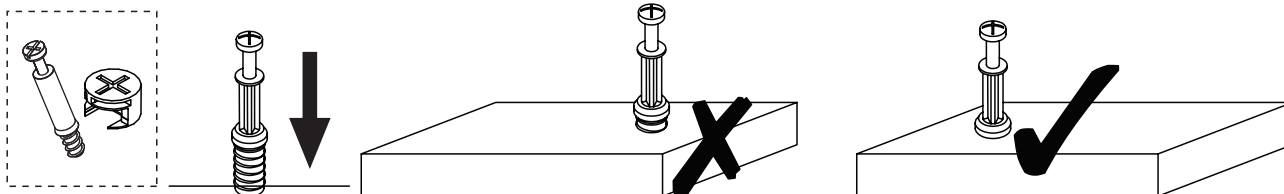

EN_QUICKFIT: Tighten quickfit until shoulder is flush with panel. Do not overtighten or undertighten.

FR_RACCORD RAPIDE: Faites serrer le raccord rapide jusqu'à ce que l'épaulement soit parfaitement encastré dans le panneau. Il ne faut ni trop serrer ni insuffisamment serrer.

ES_QUICKFIT: Apriete quickfit hasta que el hombro se descargue con el panel. NO lo sobreapriete ni lo apriete poco.

PT_AJUSTE RÁPIDO: Aperte o ajuste rápido até estar nivelada com o painel. Não apertar demasiado ou excessivamente.

DE_QUICKFIT: Ziehen Sie den Quickfit fest, bis die Schulter mit der Platte bündig ist. Bitte nicht zu fest oder zu schwach anziehen.

IT_MONTAGGIO RAPIDO: Stringere il montaggio rapido fino a quando la spalla è a filo con il pannello, non stringere troppo o troppo poco.

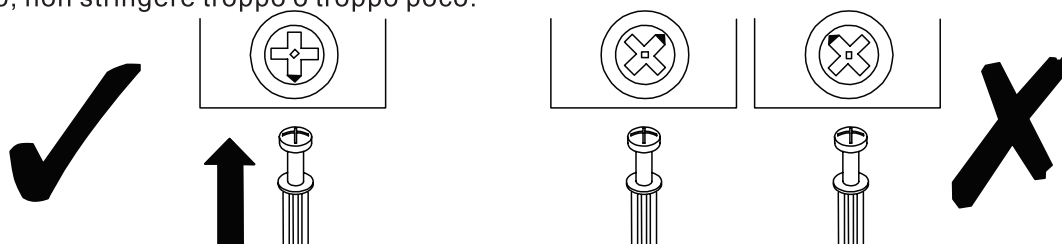

EN_CAM LOCK: When fitting cam lock, ensure starting position is correct before you insert connecting quickfit.

FR_SERRURE BATTEUSE: Avant d'insérer la serrure batteuse, veillez à la bonne orientation avant d'insérer le raccord rapide.

ES_CIERRE DE LA CÁMARA: Cuando instale el cierre de la cámara, asegúrese de que la posición de inicio es correcta antes de que inserte el quickfit conector.

PT_BLOQUEIO: Ao instalar o bloqueio, assegurar-se de que a posição inicial está correcta antes de inserir o encaixe de ligação rápida.

DE_CAM-LOCK: Achten Sie bei der Montage des Cam-Locks auf die richtige Ausgangsposition, bevor Sie den Quickfit einsetzen.

IT_BLOCCAGGIO A CAMMA: Quando si monta il bloccaggio a camma, assicurarsi che la posizione iniziale sia corretta prima di inserire il montaggio rapido di collegamento.

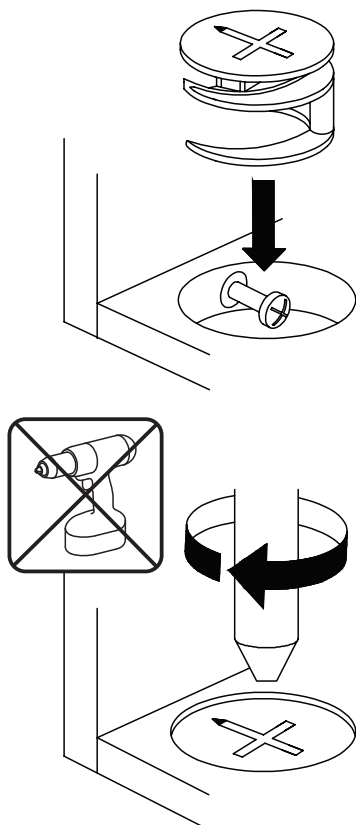

EN_Quickfit head should be in the centre of the cam lock when the two panels are joined.

Cam lock should be inserted before quickfit.

FR_Lorsque les deux panneaux sont assemblés, la tête du raccord rapide doit reposer au centre de la serrure batteuse.

Il faut insérer la serrure batteuse avant le raccord rapide.

ES_El cabezal del quickfit debe estar en el centro del cierre de la cámara cuando se unan los dos paneles.

Se debe insertar el cierre de la cámara antes que el quickfit.

PT_A cabeça de ajuste rápido deve estar no centro da fechadura quando os dois painéis estão unidos.

A fechadura de cames deve ser inserida antes de ser rápida.

DE_Der Quickfit-Kopf sollte sich in der Mitte des Cam-Locks befinden, wenn die beiden Platten zusammengefügt sind.

Der Cam-Lock sollte vor dem Quickfit eingesetzt werden.

IT_La testa del montaggio rapido deve trovarsi al centro del bloccaggio a camma quando i due pannelli sono uniti.

Il Bloccaggio a Camma deve essere inserito prima del montaggio rapido.

EN_Turn cam lock clockwise to tighten.

FR_Faites tourner la serrure batteuse dans le sens des aiguilles d'une montre pour la resserrer.

ES_Gire el cierre de la cámara en sentido horario para apretarlo.

PT_Rodar o bloqueio no sentido dos ponteiros do relógio para o apertar.

DE_Drehen Sie den Cam-Lock im Uhrzeigersinn, um ihn festzuziehen.

IT_Ruotare il bloccaggio a camma in senso orario per stringere.

PARTS LIST

① 2PCS

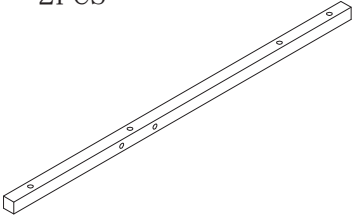

② 2PCS

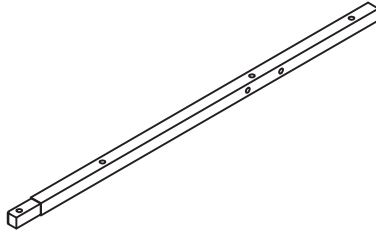

③ 2PCS

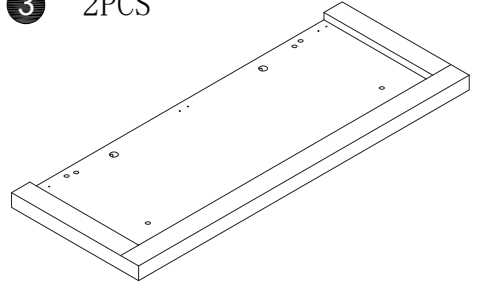

④ 2PCS

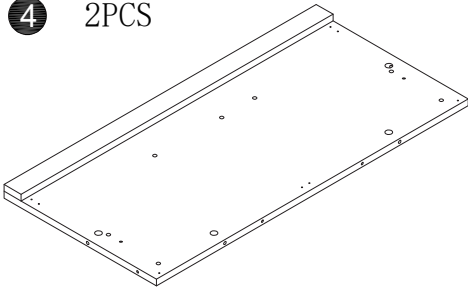

⑤ 2PCS

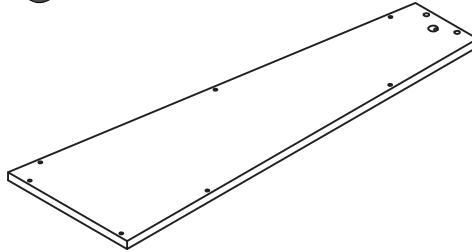

⑥ 2PCS

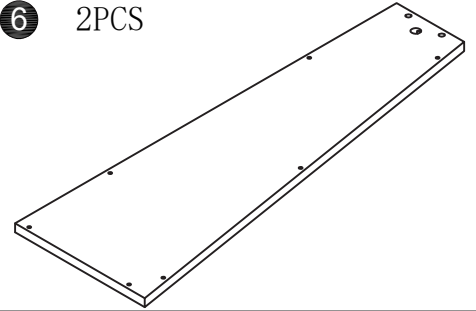

⑦ 2PCS

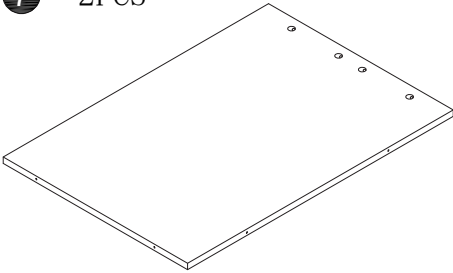



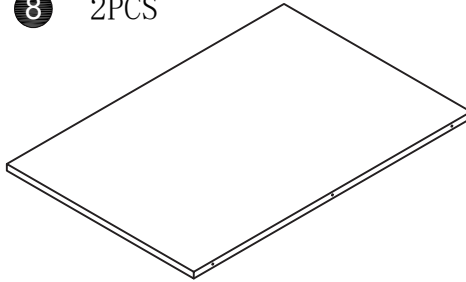



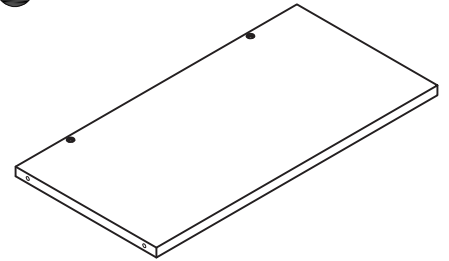

⑧ 2PCS

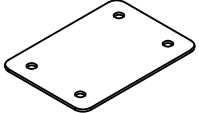

⑨ 2PCS

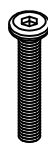
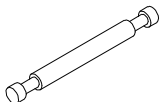

HARDWARE LIST

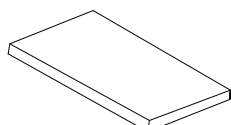
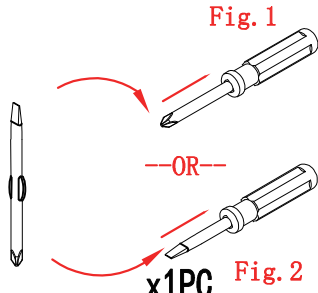
 <p>M4 Ax1PC</p>	 <p>M5*46mm Bx32PCS+2 (spare)</p>	 <p>φ6*30mm Cx4PCS+1 (spare)</p>
 <p>45*32*0.8mm Dx7PCS+1 (spare)</p>	 <p>φ7*M3.5*12mm Ex28PCS+2 (spare)</p>	 <p>φ6.5*36mm F1x12PCS+1 (spare)</p>
 <p>φ15*12mm F2x24PCS+2 (spare)</p>	 <p>φ11*M6*28mm Gx22PCS+2 (spare)</p>	 <p>φ5*54mm Hx6PCS+1 (spare)</p>
 <p>φ6*50mm Ix6PCS+1 (spare)</p>	 <p>Jx8PCS+1 (spare)</p>	 <p>x1PC</p>

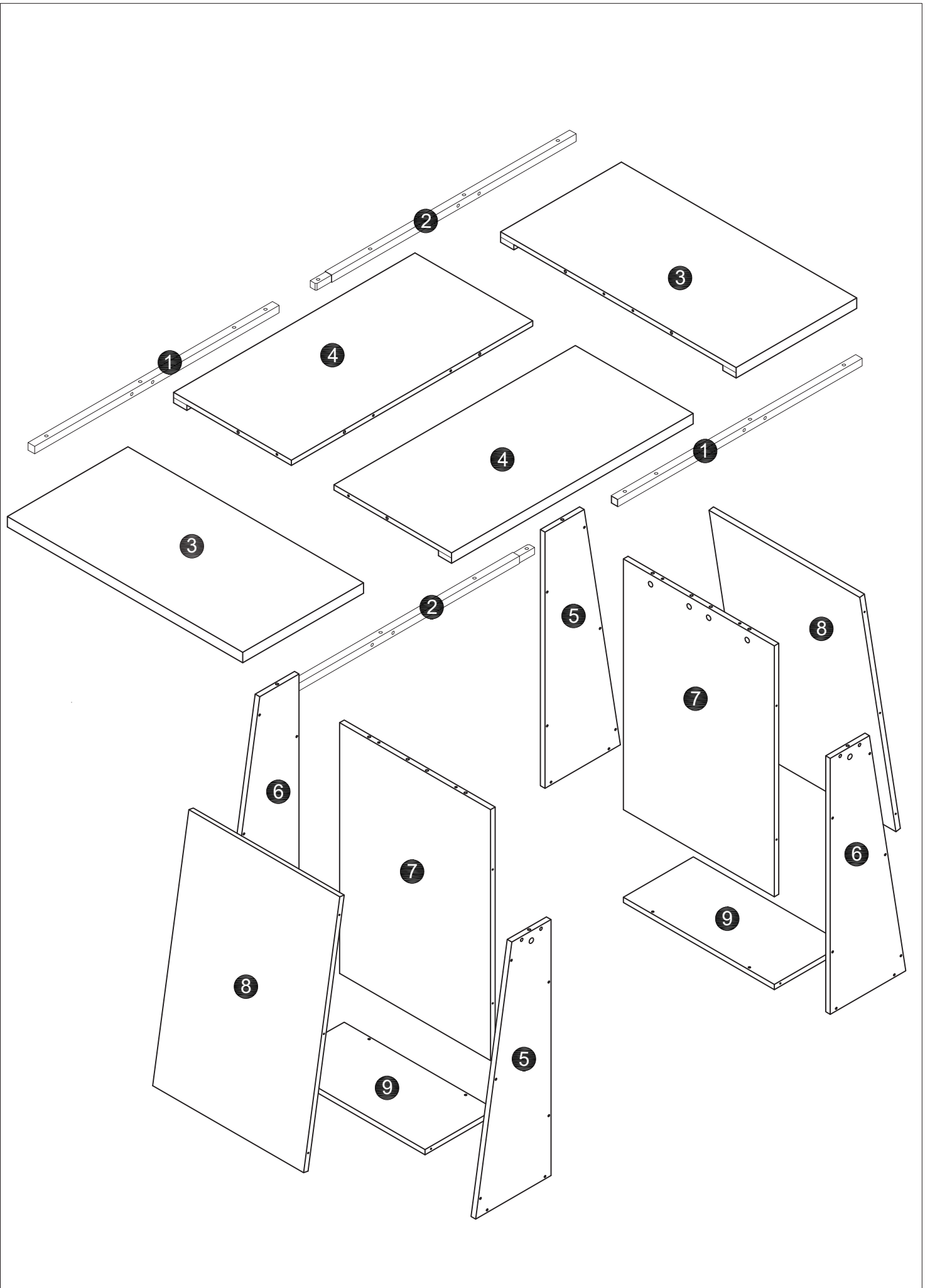

1

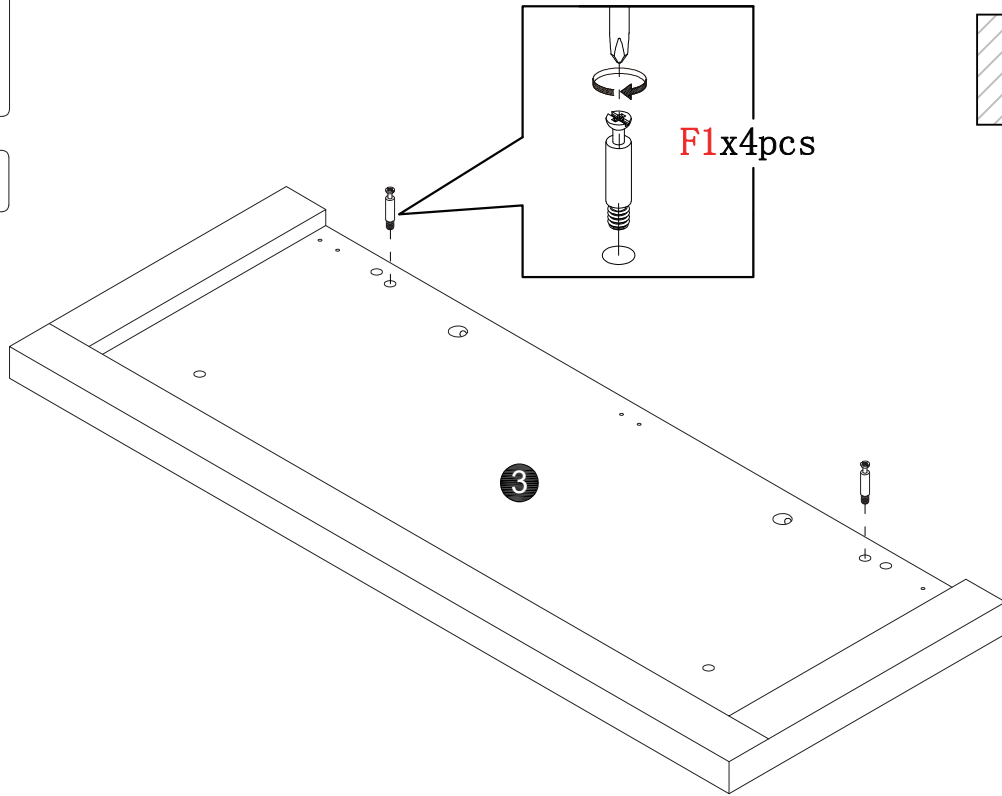
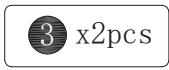
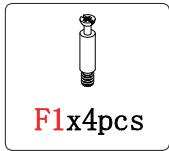

x2

2

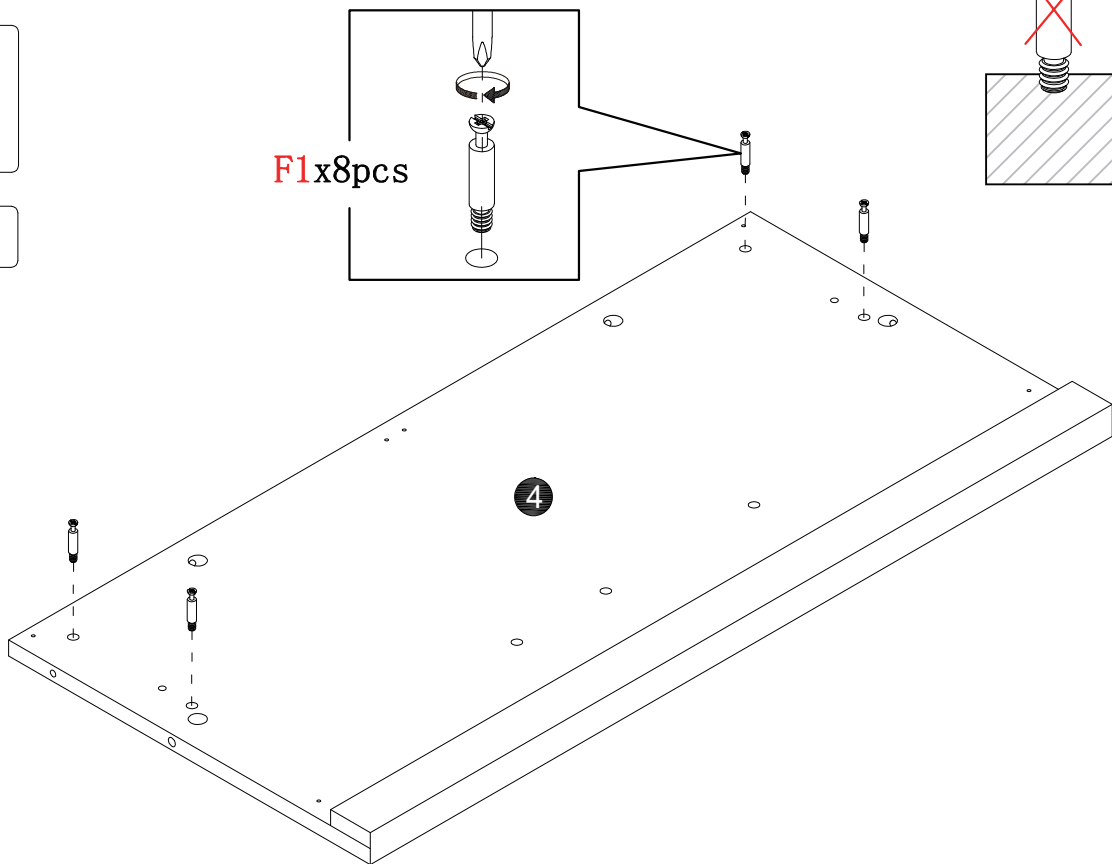
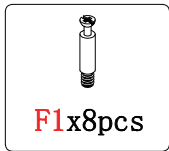

x2

3

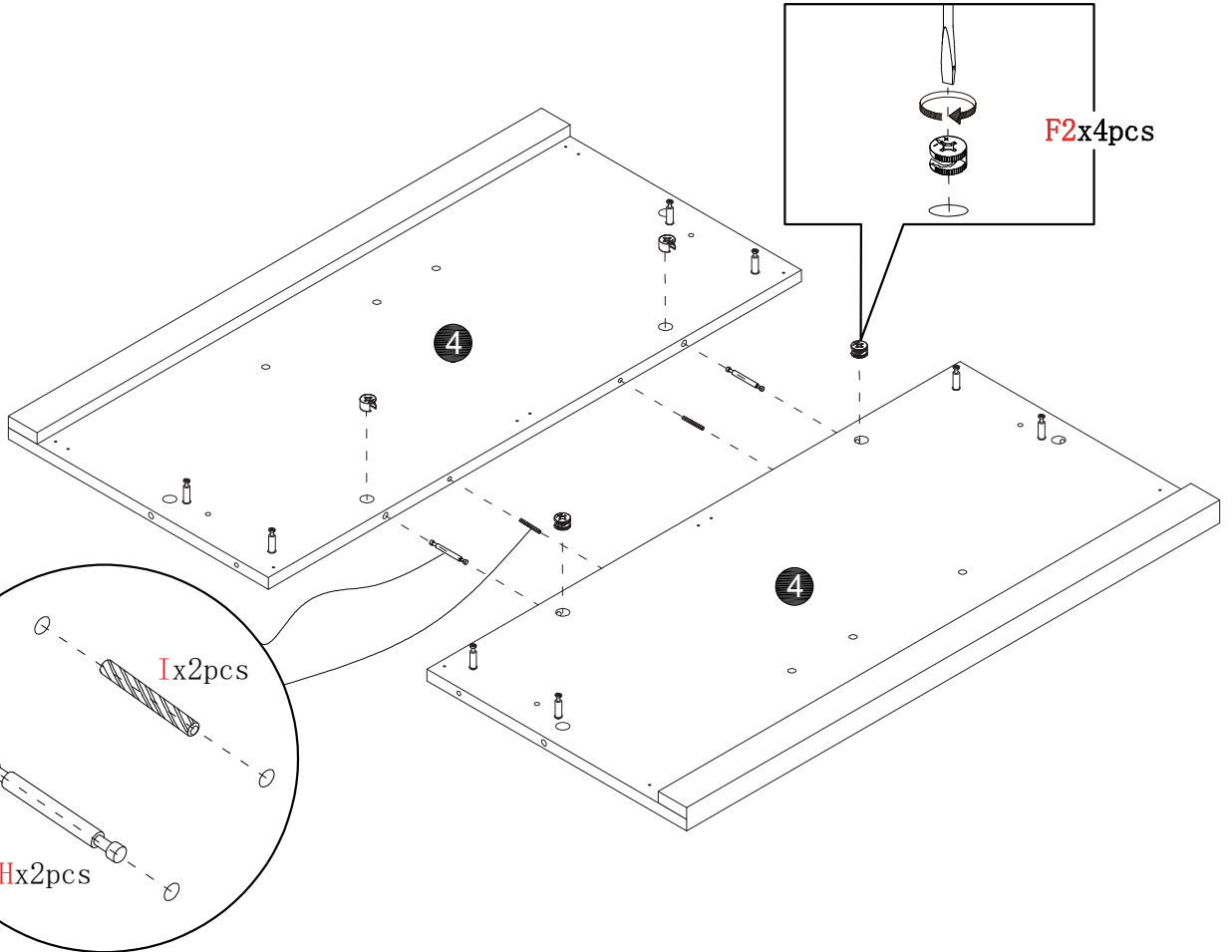
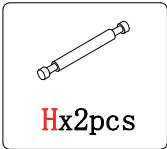
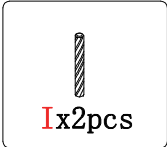

4

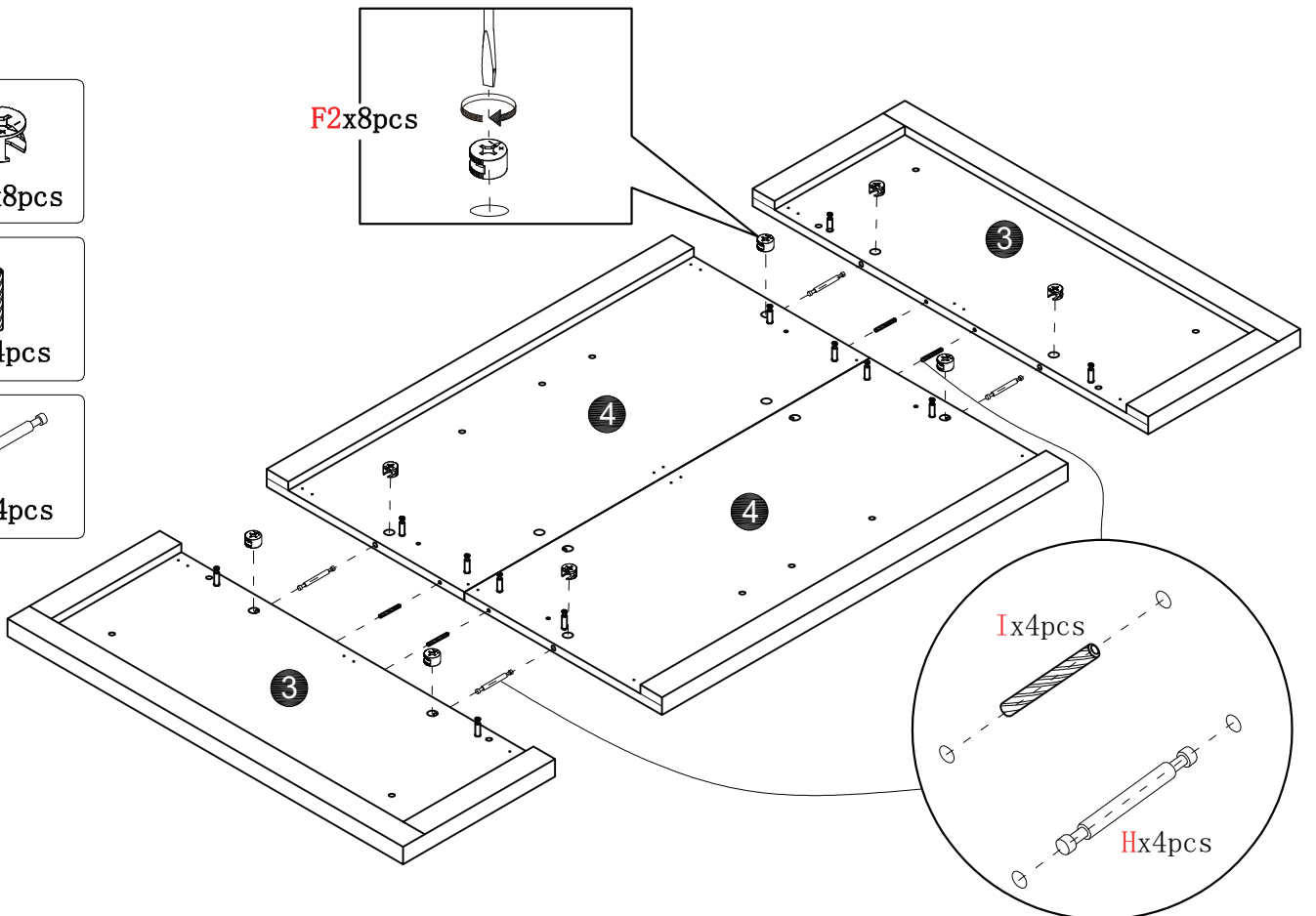
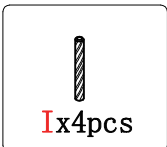

5

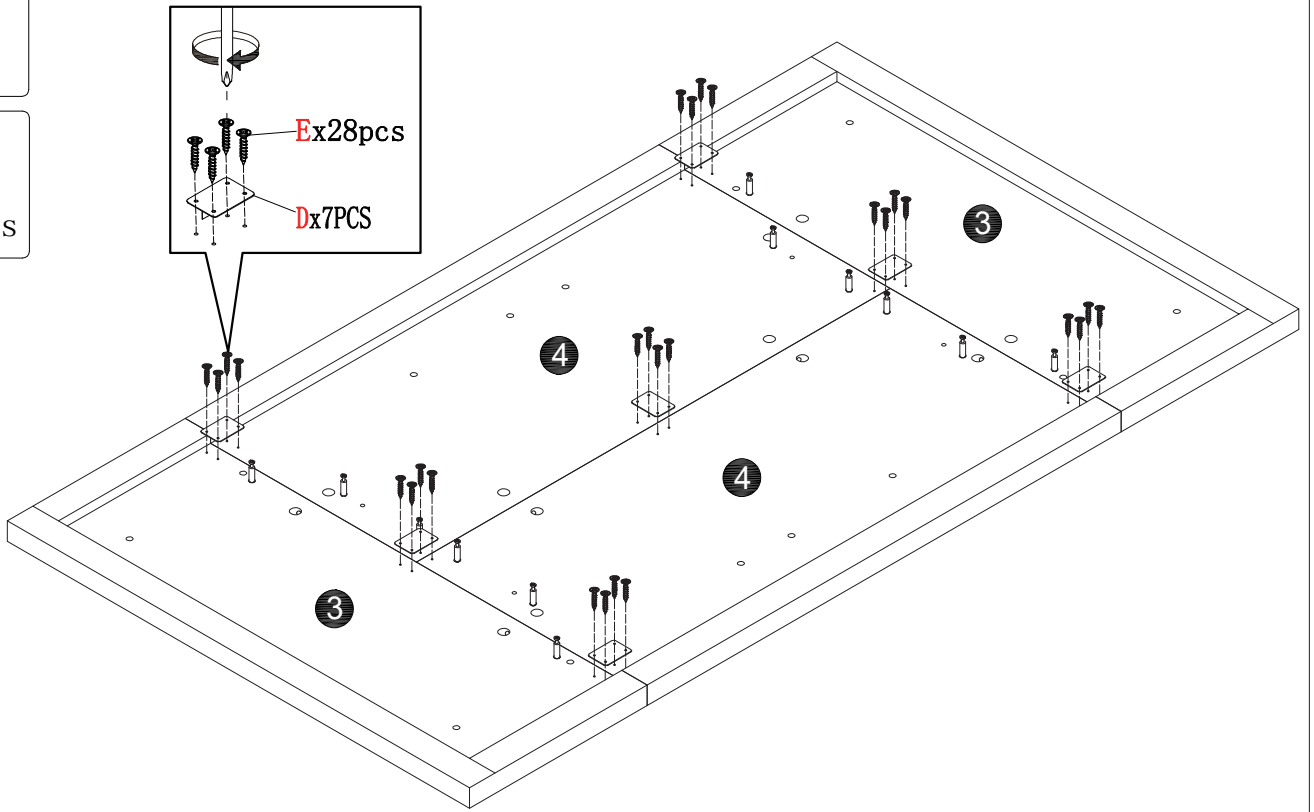
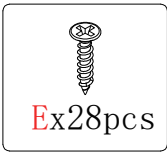
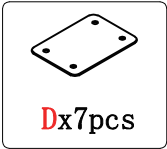

6

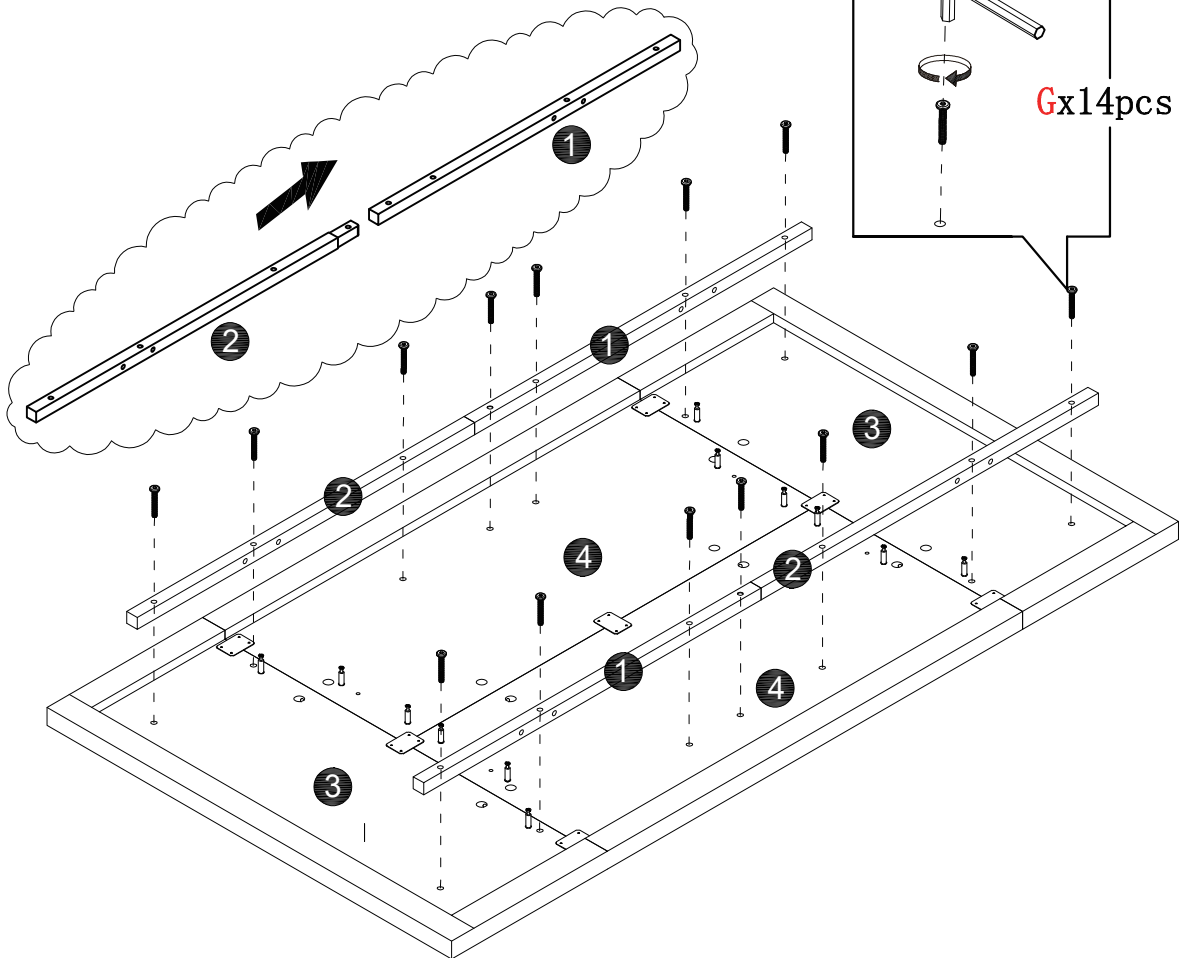
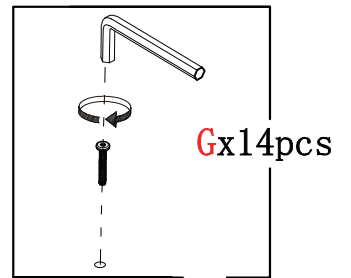
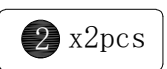
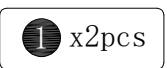
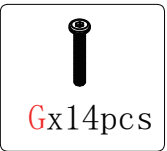

7

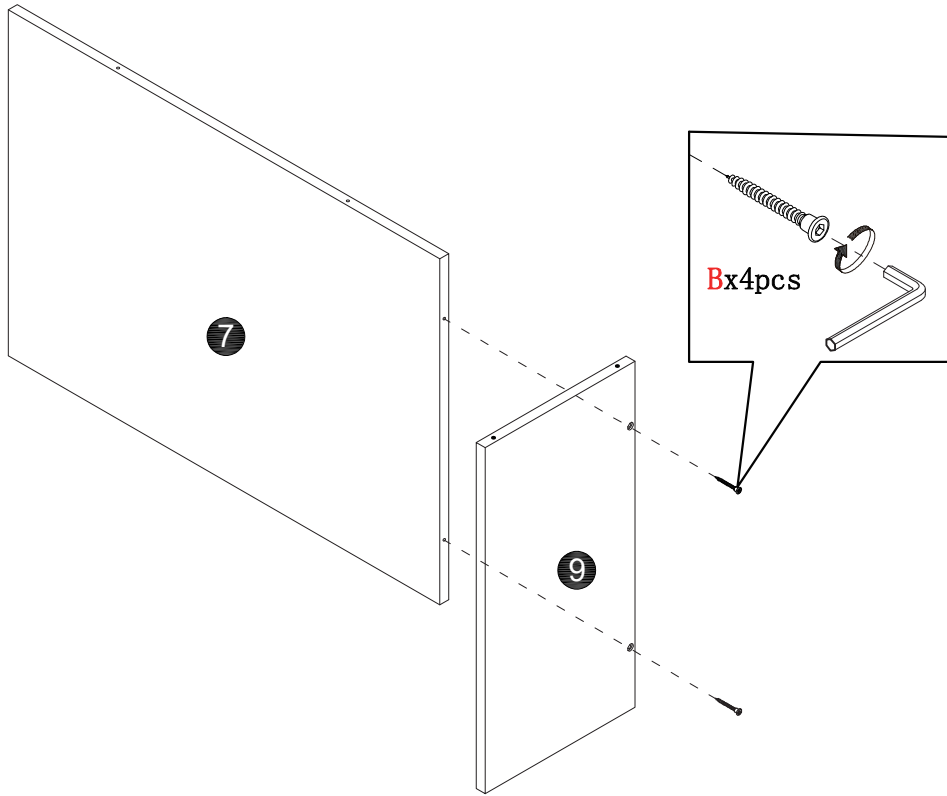
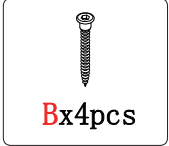

x2

8

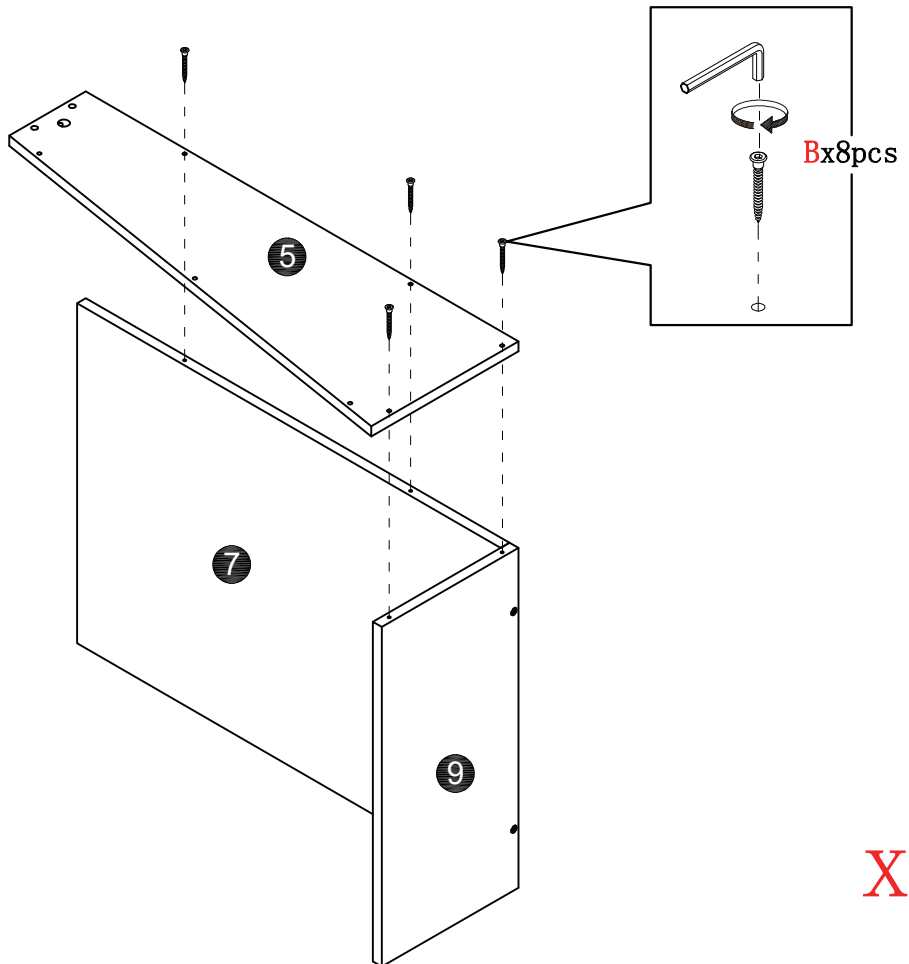
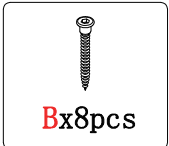

x2

9

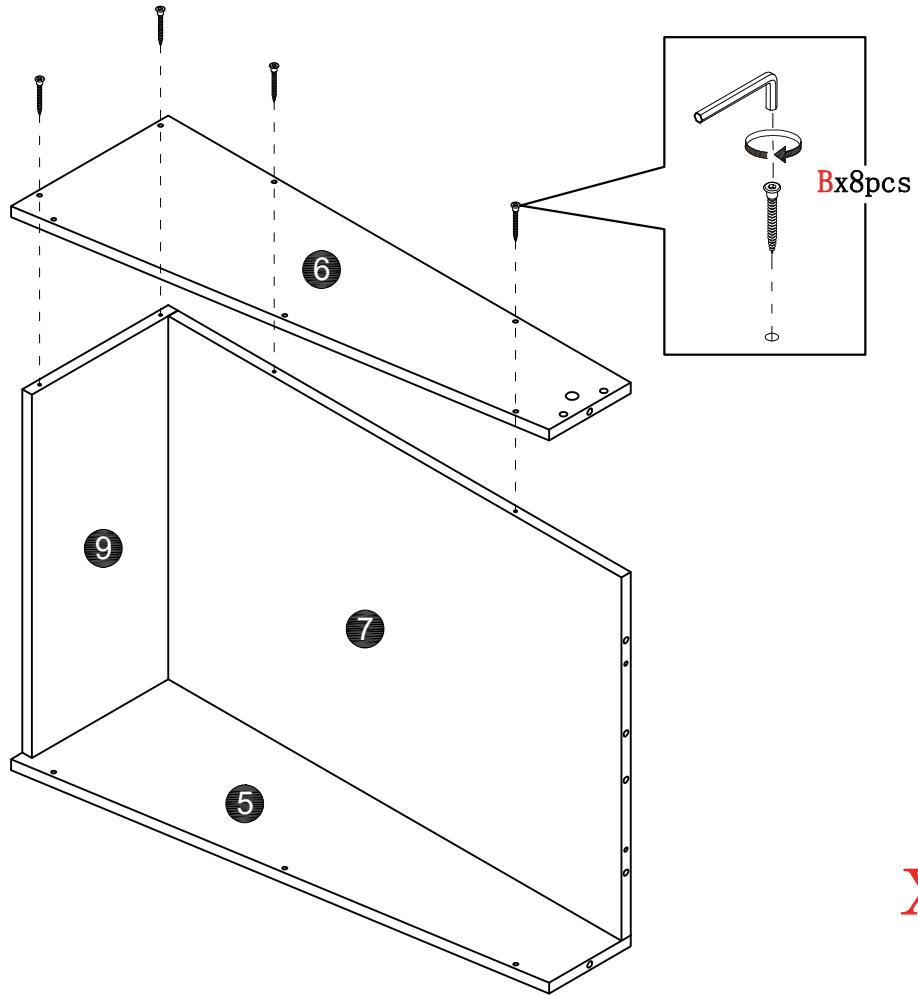
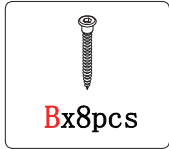

10

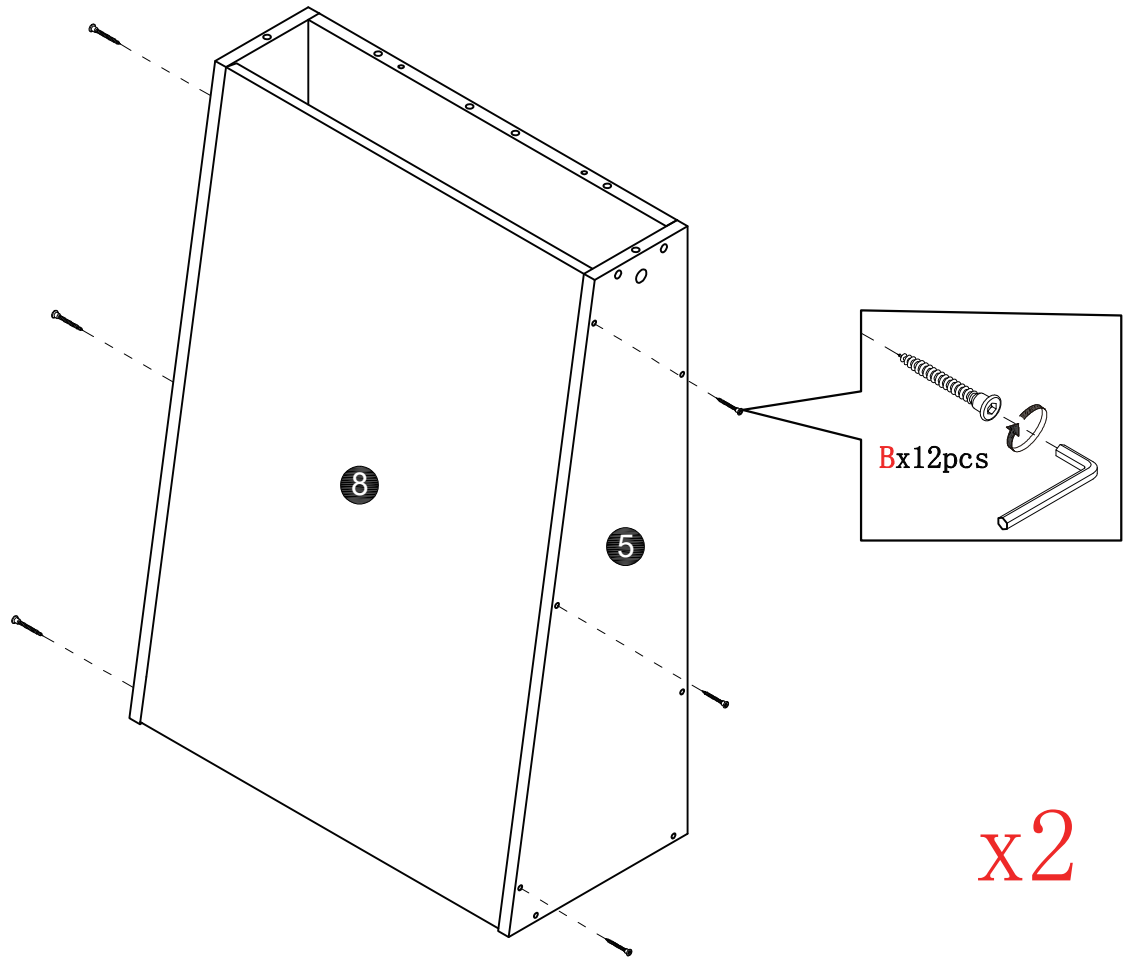
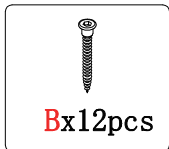

11

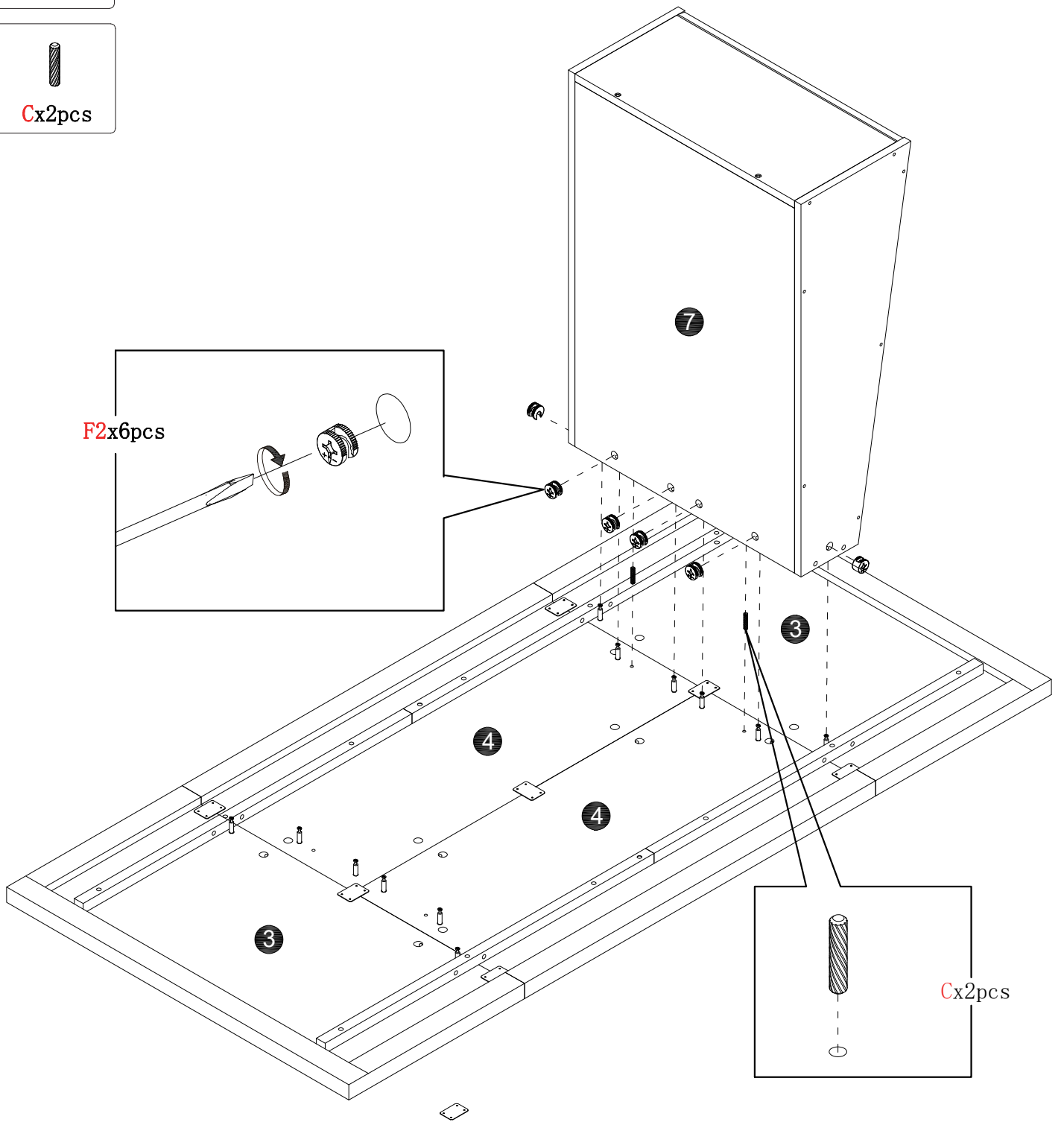
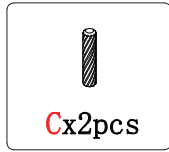

12



F2x6pcs



Cx2pcs

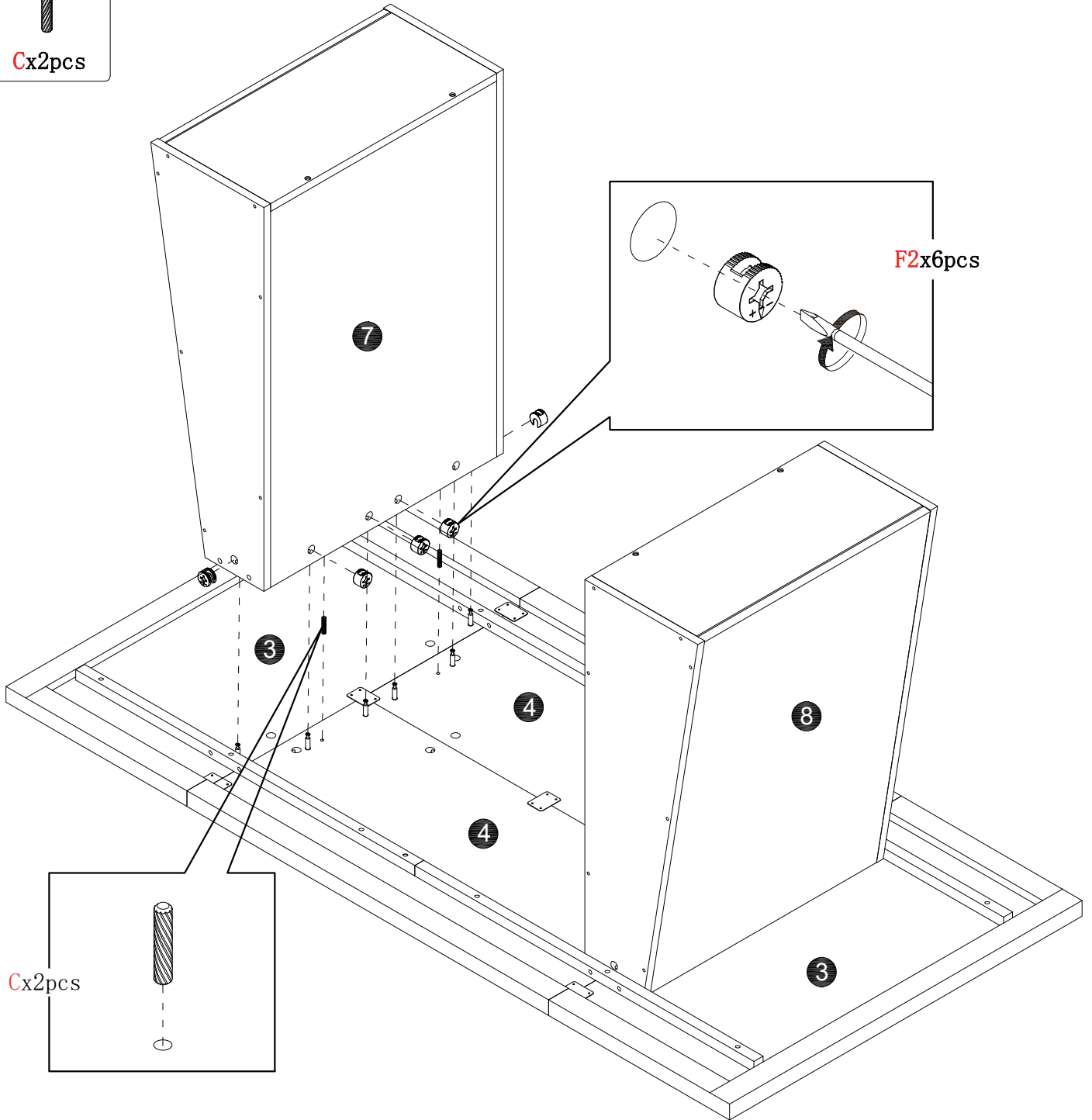

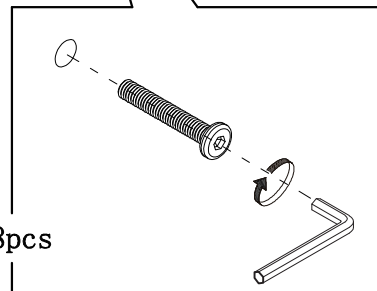
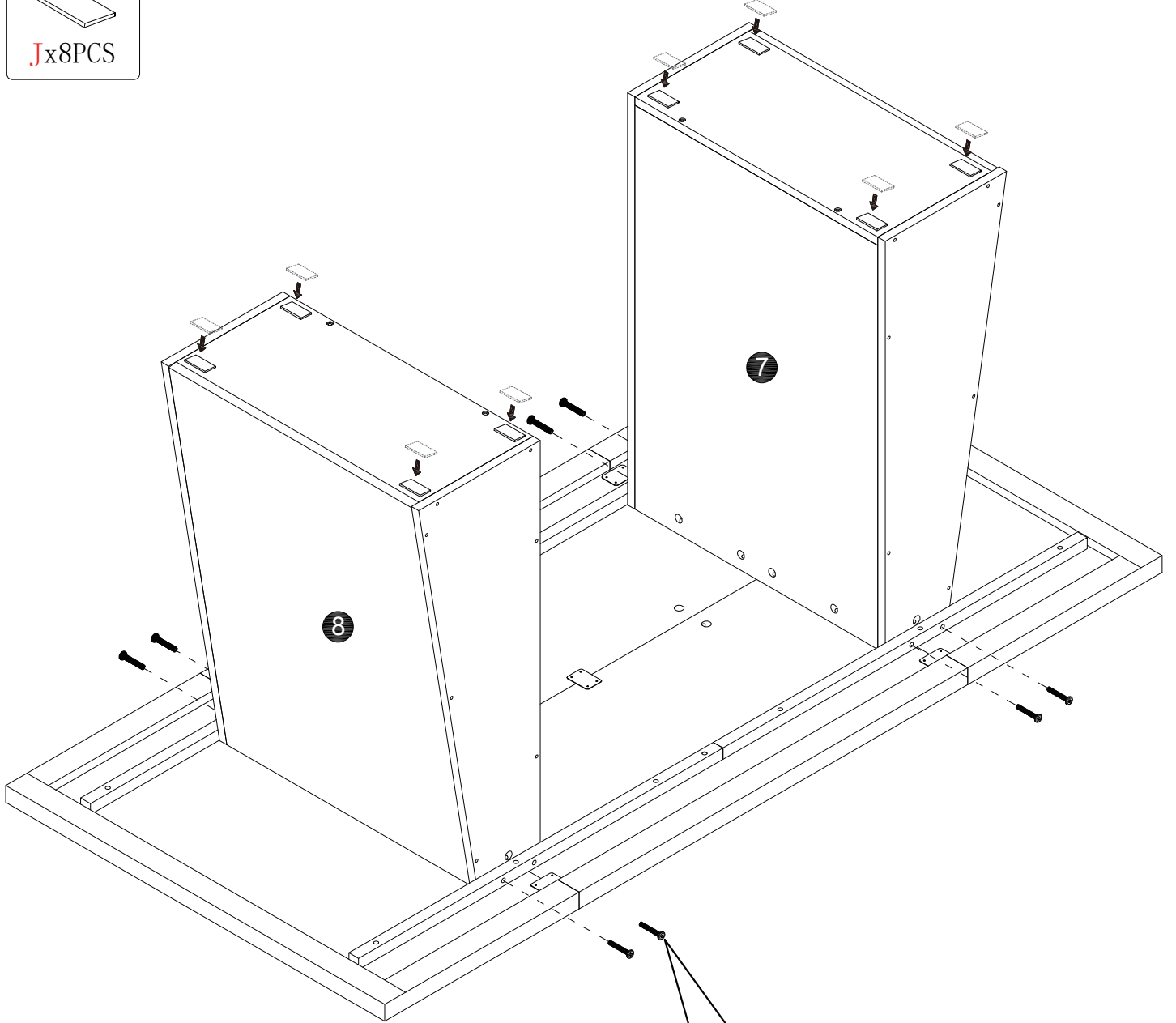
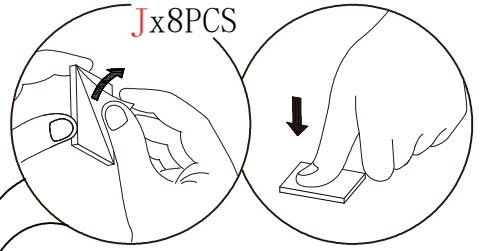
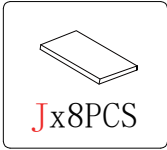

13



If you have any questions, please contact our customer care center, Our contact details are below:

US

 001-877-644-9366

 customerservice@aosom.com

Imported by Aosom LLC
27150 SW Kinsman Rd Wilsonville, OR 97070 USA
MADE IN CHINA

If you have any questions, please contact our customer care center, Our contact details are below:

CA

 416-792-6088

 customerservice@aosom.ca

Imported by Aosom Canada Inc.
7270 Woodbine Avenue, Unit 307, Markham,
Ontario Canada L3R 4B9
MADE IN CHINA

Si vous avez la moindre question, veuillez contacter notre centre d'assistance à la clientèle, Nos coordonnées sont les suivantes:

 416-792-6088

 customerservice@aosom.ca

Importé par Aosom Canada Inc.
7270 Woodbine Avenue, unité 307,
Markham, Ontario Canada L3R 4B9
FABRIQUÉ EN CHINE

If you have any questions, please contact our customer care center, Our contact details are below:

UK

 0044-800-240-4004

 enquiries@mhstar.co.uk

IMPORTER ADDRESS:
MH STAR UK Ltd
1 Northampton Cross Logistics Park
Northampton Cross Road
Northampton
NN4 9FH
MADE IN CHINA

Si vous avez la moindre question, veuillez contacter notre centre d'assistance à la clientèle, Nos coordonnées sont les suivantes:

FR

 0033-1-84166106

 aosom@mhfrance.fr

Importé par/Fabricant/REP:
MH FRANCE
2 Rue Maurice Hartmann
92130 Issy Les Moulineaux
France
FABRIQUÉ EN CHINE

Wenn Sie Fragen haben, wenden Sie sich bitte an unser Kundendienstzentrum, Unsere Kontaktdaten stehen unten:

DE

 +49 40 87408465

 service@aosom.de

ADRESSE DES IMPORTEUR/Hersteller/REP:
MH Handel GmbH
Wendenstraße 309
D-20537 Hamburg
Germany
IN CHINA HERGESTELLT

In caso di dubbio, si prega di contattare il nostro centro assistenza clienti, I nostri dettagli di contatto sono di seguito:

IT

 0039-0249471447

 clienti@aosom.it

IMPORTATO DA/Produttore/REP:
AOSOM Italy srl
Centro Direzionale Milanofiori
Strada 1 Palazzo F1
20057 Assago (MI)
P.I.: 08567220960
FATTO IN CINA

Si tiene alguna pregunta, comuníquese con nuestro Centro de Atención al Cliente, Nuestros datos de contacto son los siguientes:

ES

 0034-931294512

 atencioncliente@aosom.es

IMPORTADOR/Fabricante/REP:
SPANISH AOSOM, S.L.
C/ROC GROS, N°15.08550, ELS HOSTALETES DE
BALENYÀ, SPAIN.
B66295775
HECHO EN CHINA

Se tiver alguma dúvida, por favor contacte o nosso Centro de Atendimento ao Cliente, Os nossos dados de contacto são os seguintes:

 0034-931294512

 info@aosom.pt.

IMPORTADOR/Fabricante/REP:
SPANISH AOSOM, S.L.
C.ROC GROS N.15, 08550. ELS HOSTALETES DE
BALENYÀ
FEITO NA CHINA



FR

**DONNEZ
OU
RECYCLEZ**



ASSOCIATION

OU



LIVRAISON

OU



DÉCHÈTERIE

Adresses sur quefairedemesdechets.fr