

# PawHut

IN251100436V01

**D51-535V00**

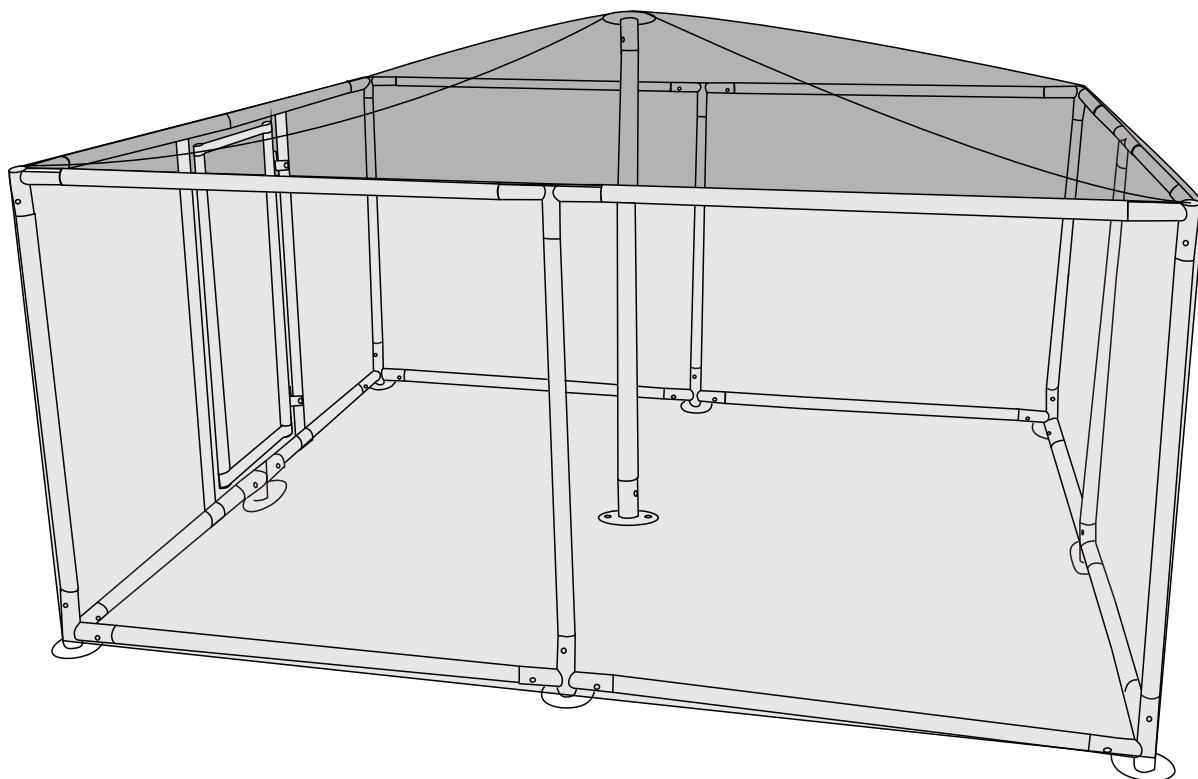

**11**  
STEPS

  
2HR



**EN\_ IMPORTANT, RETAIN FOR FUTURE REFERENCE: READ CAREFULLY.**

**FR\_ IMPORTANT: A LIRE ATTENTIVEMENT ET À CONSERVER POUR CONSULTATION ULTÉRIEURE.**

**ES\_ IMPORTANTE, LEA Y GUARDE PARA FUTURAS REFERENCIAS.**

**PT\_ IMPORTANTE: LEIA ATENTAMENTE E GUARDE PARA CONSULTA FUTURA.**

**DE\_ WICHTIG! SORGFÄLTIG LESEN UND FÜR SPÄTER NACHSCHLAGEN AUFBEWAHREN.**

**IT\_ IMPORTANTE! CONSERVARE IL PRESENTE MANUALE PER FUTURO RIFERIMENTO E  
LEggerlo ATTENTAMENTE.**

**RO\_ IMPORTANT: CITIȚI CU ATENȚIE ȘI PĂSTRAȚI PENTRU CONSULTARE VIITOARE.**

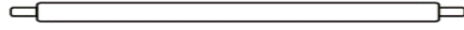

**1** x 7  
1414



**2** x 8  
1911

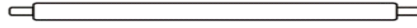

**3** x 7  
1372



**4** x 1  
1550



**5** x 1  
1440



**5A** x 1  
1440

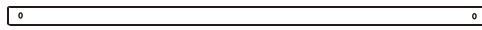

**A** x 1  
1400

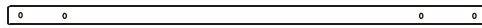

**1A** x 1  
1400



**6** x 1  
1925



**C** x 2  
565

**E1** x 2

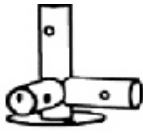

**E2** x 2

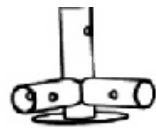

**E3** x 2

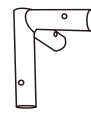

**E4** x 2

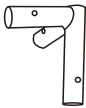

**F** x 3

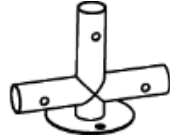

**G** x 1



**X** x 3

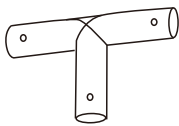

**D** x 1

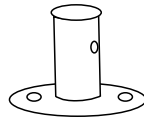

**H** x 1

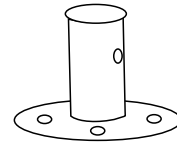

**M** x 2

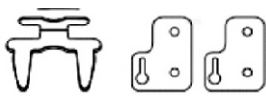

**I** x 8

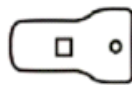

**J** x 2

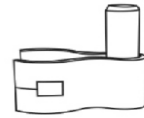

**J1** x 2



**P** x 1

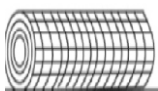

**Q** x 1

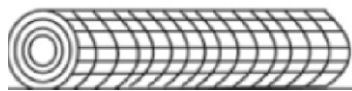

**O**



**K** x 16

M5\*30  
+2(spare)



**L** x 2

M6\*40  
+1(spare)



**W1** x 8

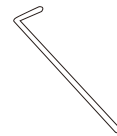

**W2** x 4

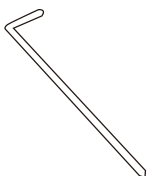

**S** x 1



**EN\_ATTENTION:** E1 & E2 shall be placed in strict order, otherwise they cannot be installed

DIFFERENT HOLES SITUATIONS IN E1&E2

**FR\_ATTENTION :** E1 & E2 doivent être placés dans un ordre strict, sinon ils ne peuvent pas être installés.

DIFFÉRENTES SITUATIONS DE TROUS DANS E1&E2

**ES\_ATENCIÓN:** E1 & E2 deben colocarse en estricto orden, de lo contrario no podrán instalarse

DIFERENTES SITUACIONES DE AGUJEROS EN E1&E2

**PT\_ATENÇÃO:** E1 e E2 devem ser colocados por ordem rigorosa, caso contrário não podem ser instalados

DIFERENTES SITUAÇÕES DE FUROS EM E1 E E2

**DE\_ACHTUNG:** E1 und E2 müssen in strenger Reihenfolge angebracht werden, sonst können sie nicht installiert werden.

UNTERSCHIEDLICHE LOCHSITUATIONEN IN E1&E2

**IT\_ATTENZIONE:** E1 ed E2 devono essere posizionati in ordine rigoroso, altrimenti non possono essere installati.

SITUAZIONI DI FORI DIVERSI IN E1&E2

**RO\_ATENȚIE:** Componentele E1 și E2 trebuie așezate în ordinea strictă indicată; în caz contrar, nu pot fi instalate. POZIȚII DIFERITE ALE ORIFICIILOR LA E1 ȘI E2

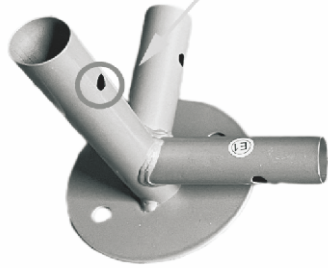

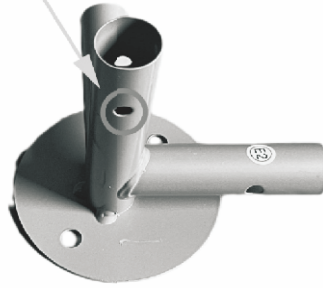

**E1**

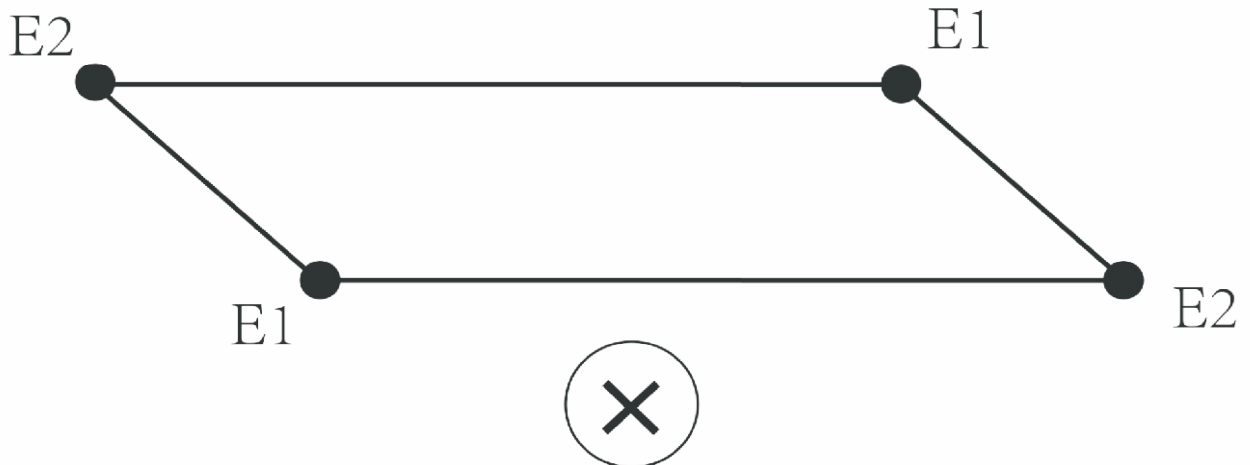
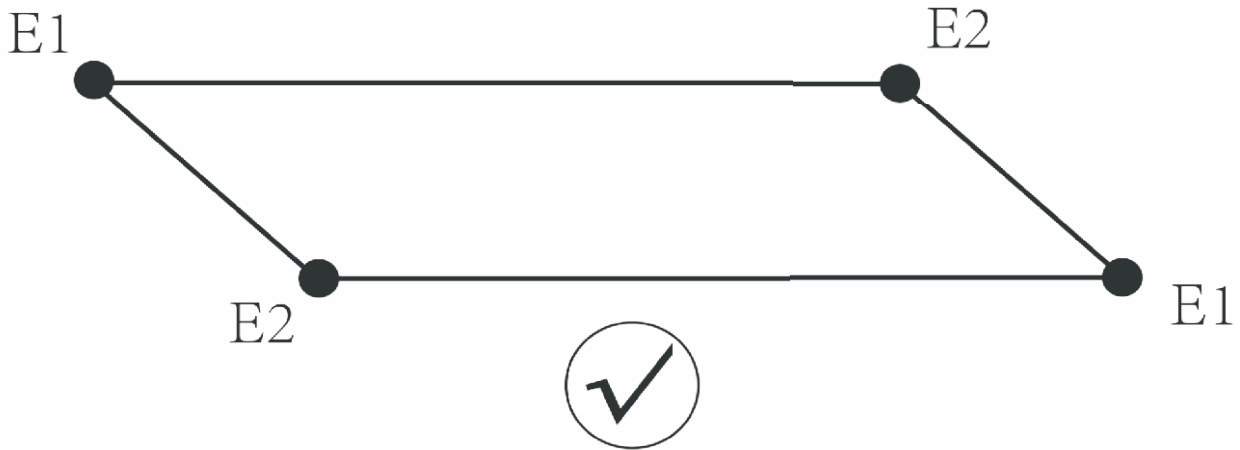

**E2**

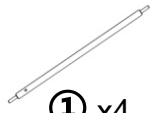
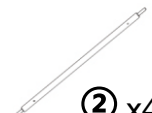
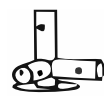
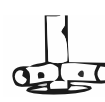
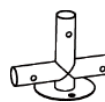

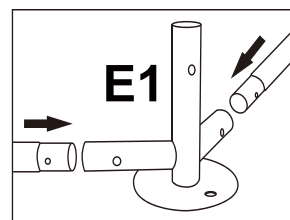
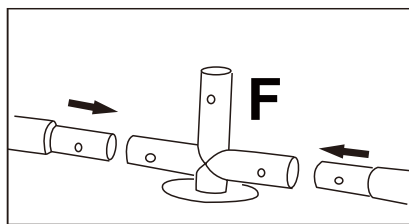
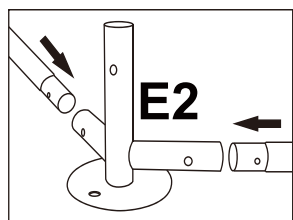
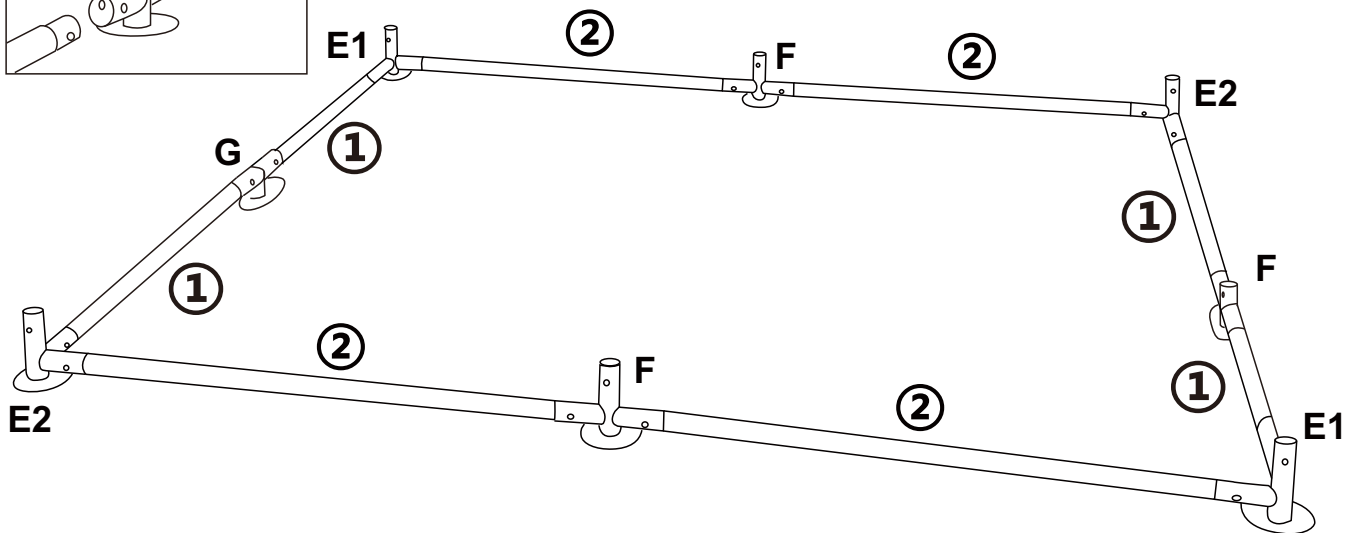
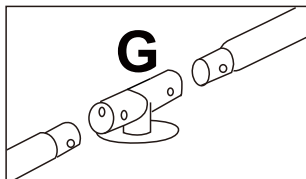

Required Tools	 ① x4	 ② x4	 E1 x2	 E2 x2	 F x3	 G x1
----------------	--	--	---	--	--	--

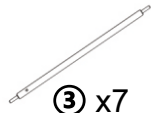

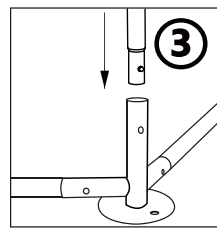
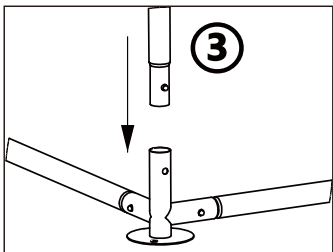
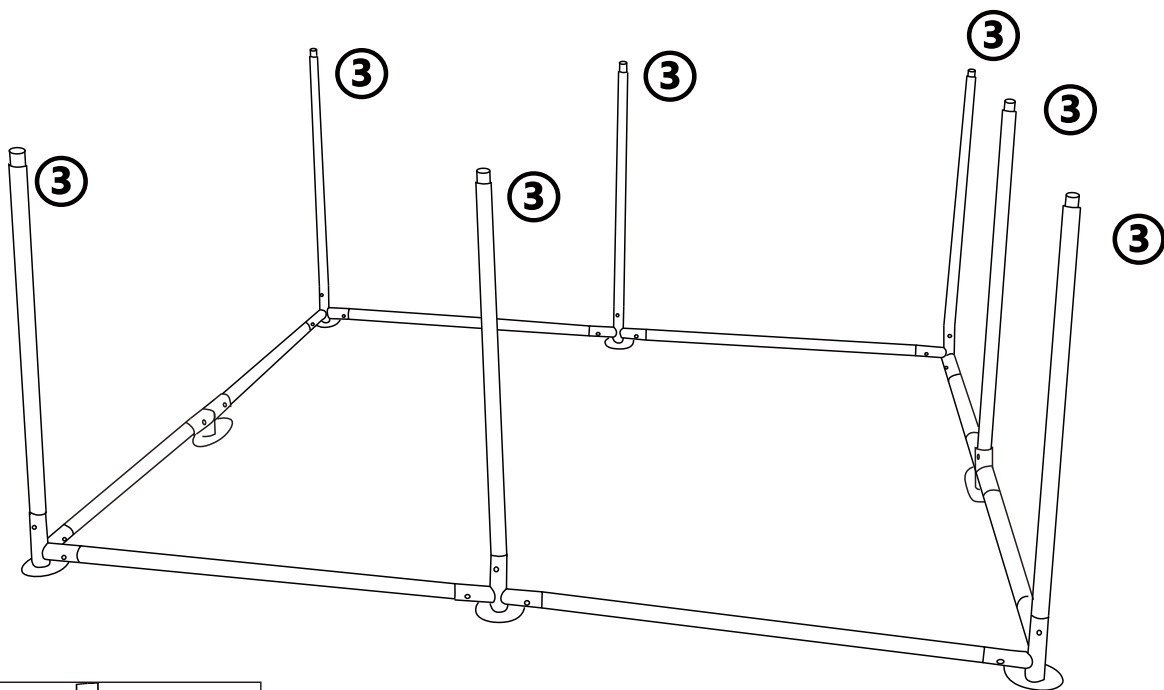

Required Tools	 ③ x7
----------------	---

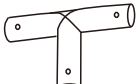

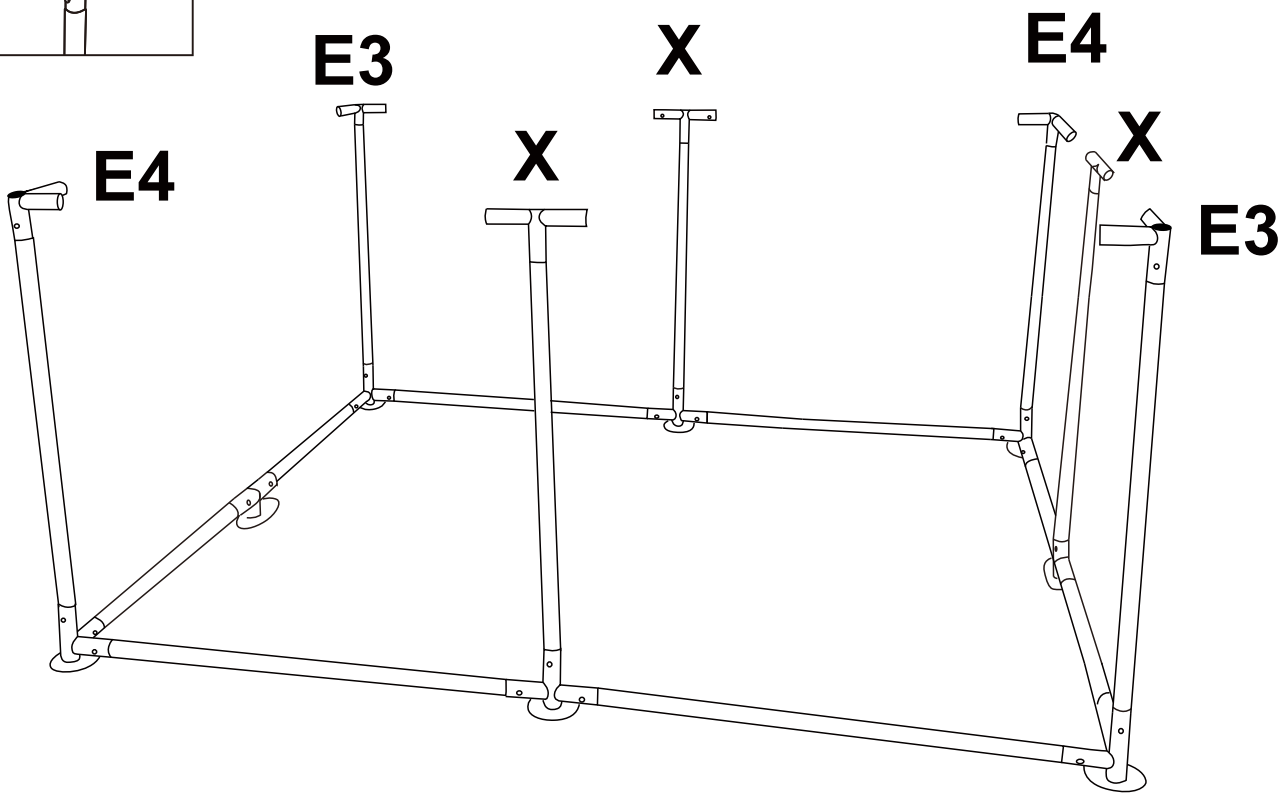
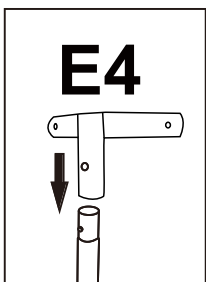



Required Tools	 E3X2	 E4X2	 Xx3
-------------------	---	---	--

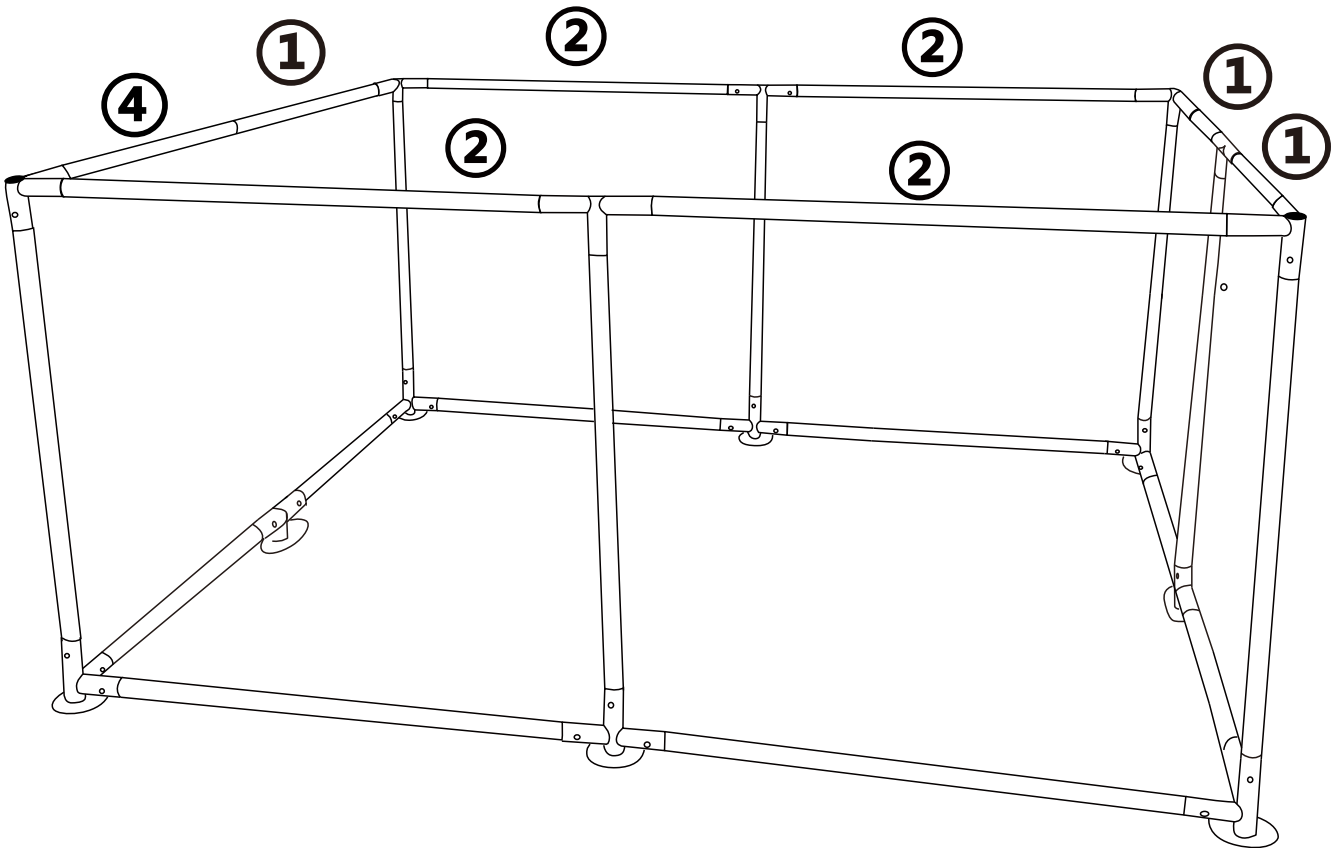

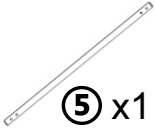
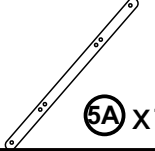

Required Tools	 ① x3	 ② x4	 ④ x1
----------------	---	---	---

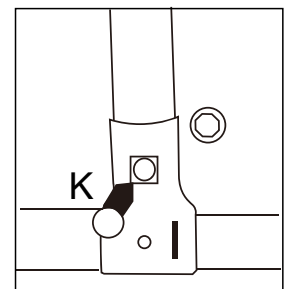
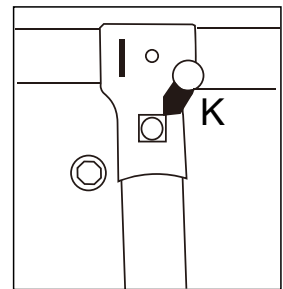
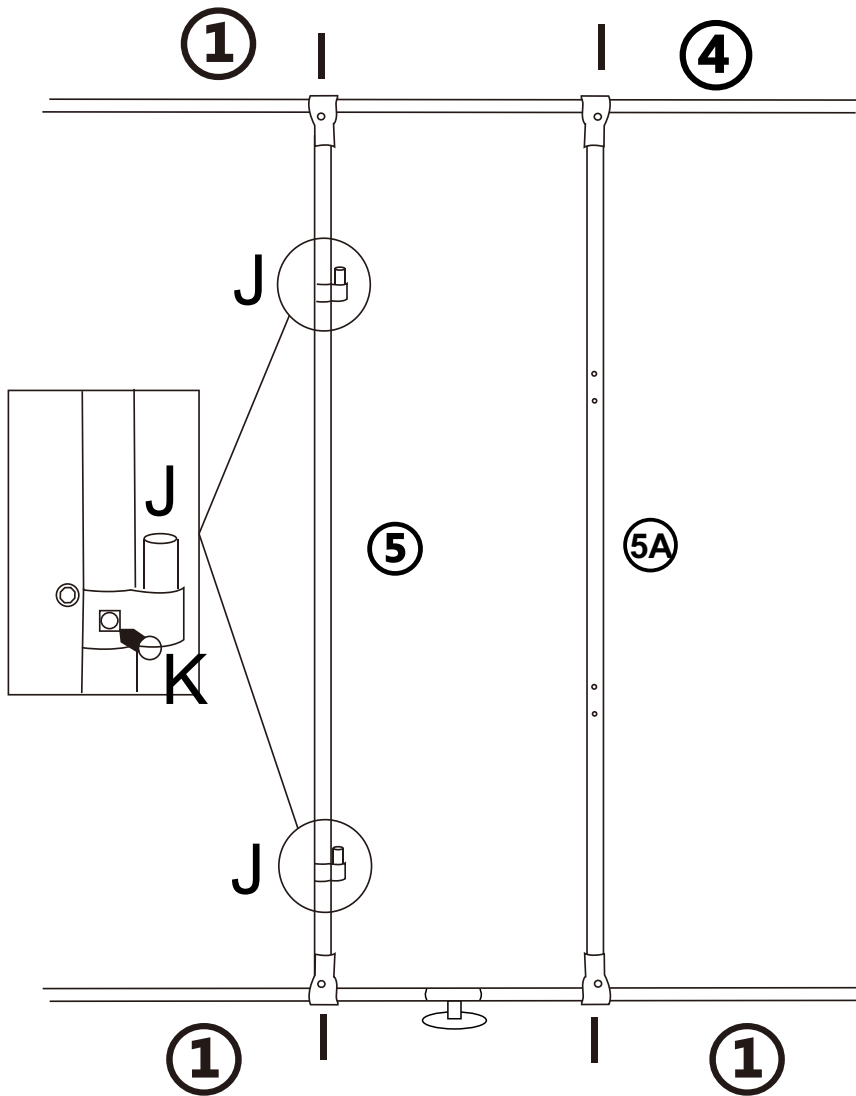

<p>Required Tools</p>	 <p>⑤ x1</p>	 <p>⑤A x1</p>	 <p>J*2PCS</p>
 <p>I*8PCS</p>	 <p>K*6PCS</p>		

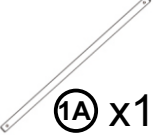
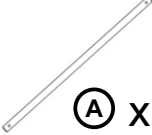
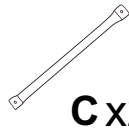



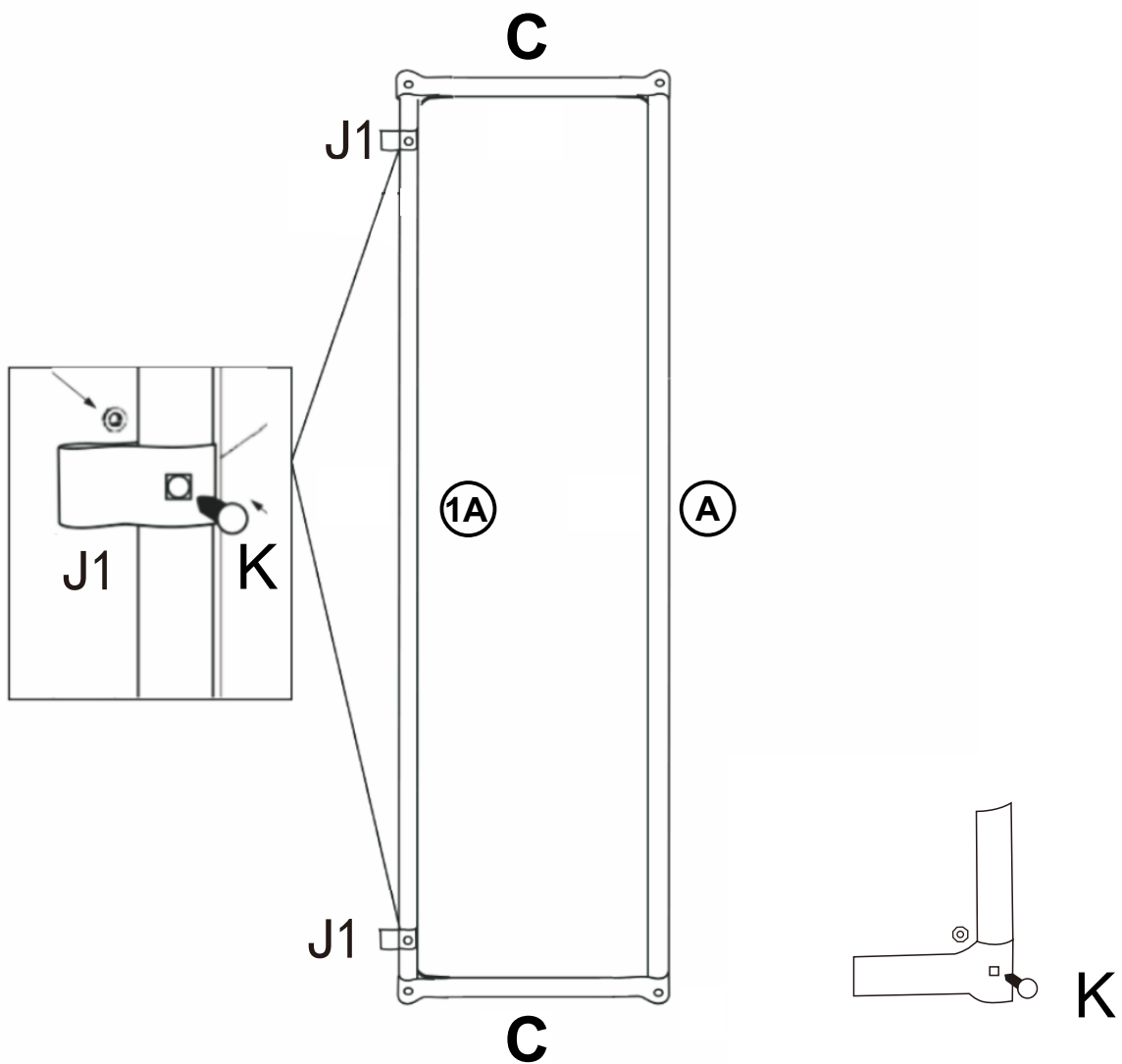

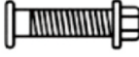
Required Tools	 ①A x1	 ①A x1	 C x2
 J1*2PCS	 K*6PCS		

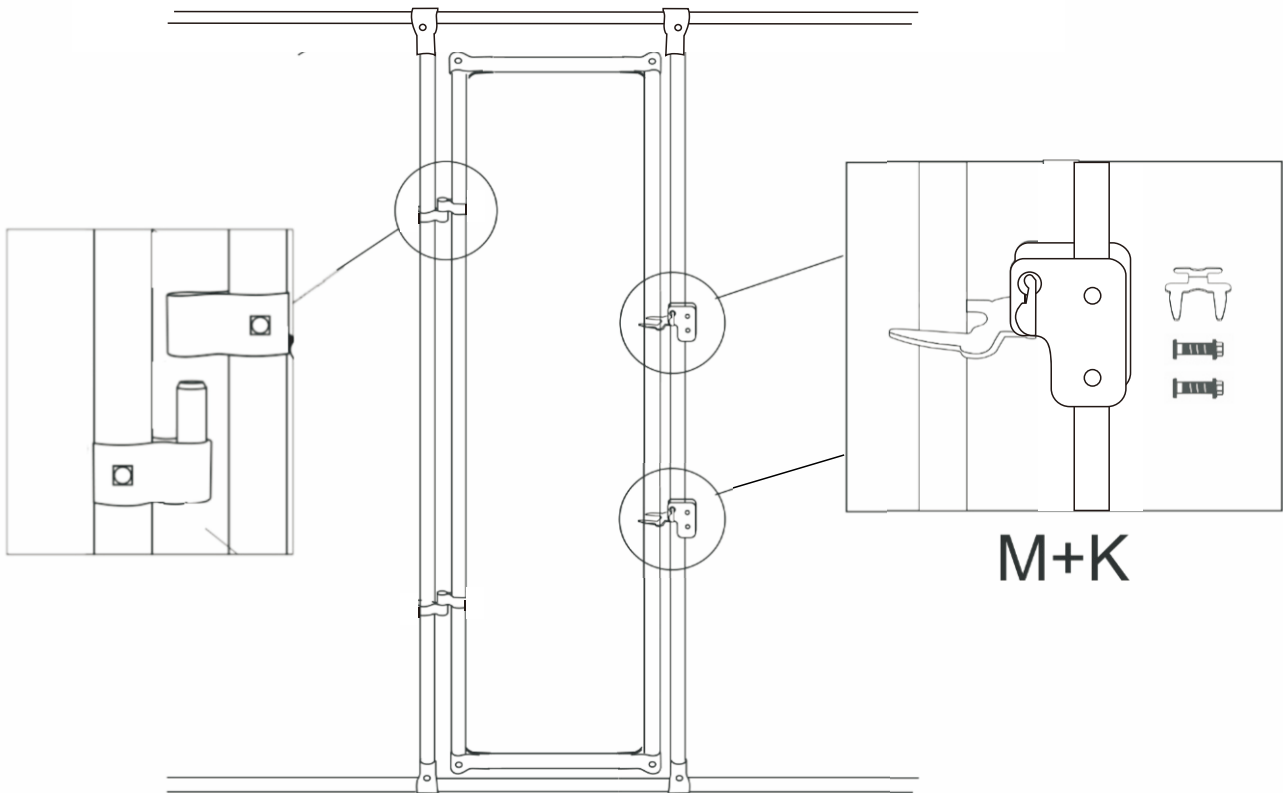

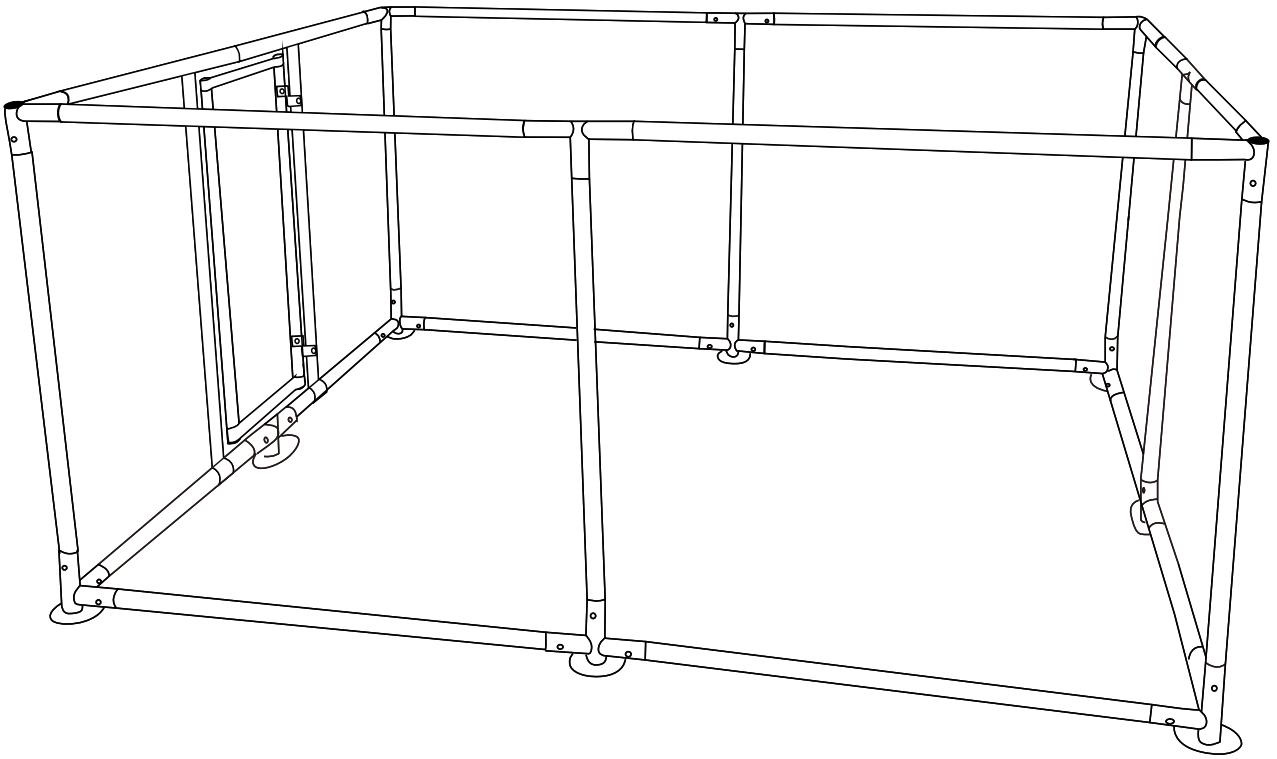

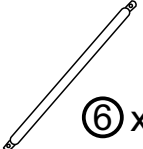

Required Tools	 Mx2	 Kx4
-------------------	--	--



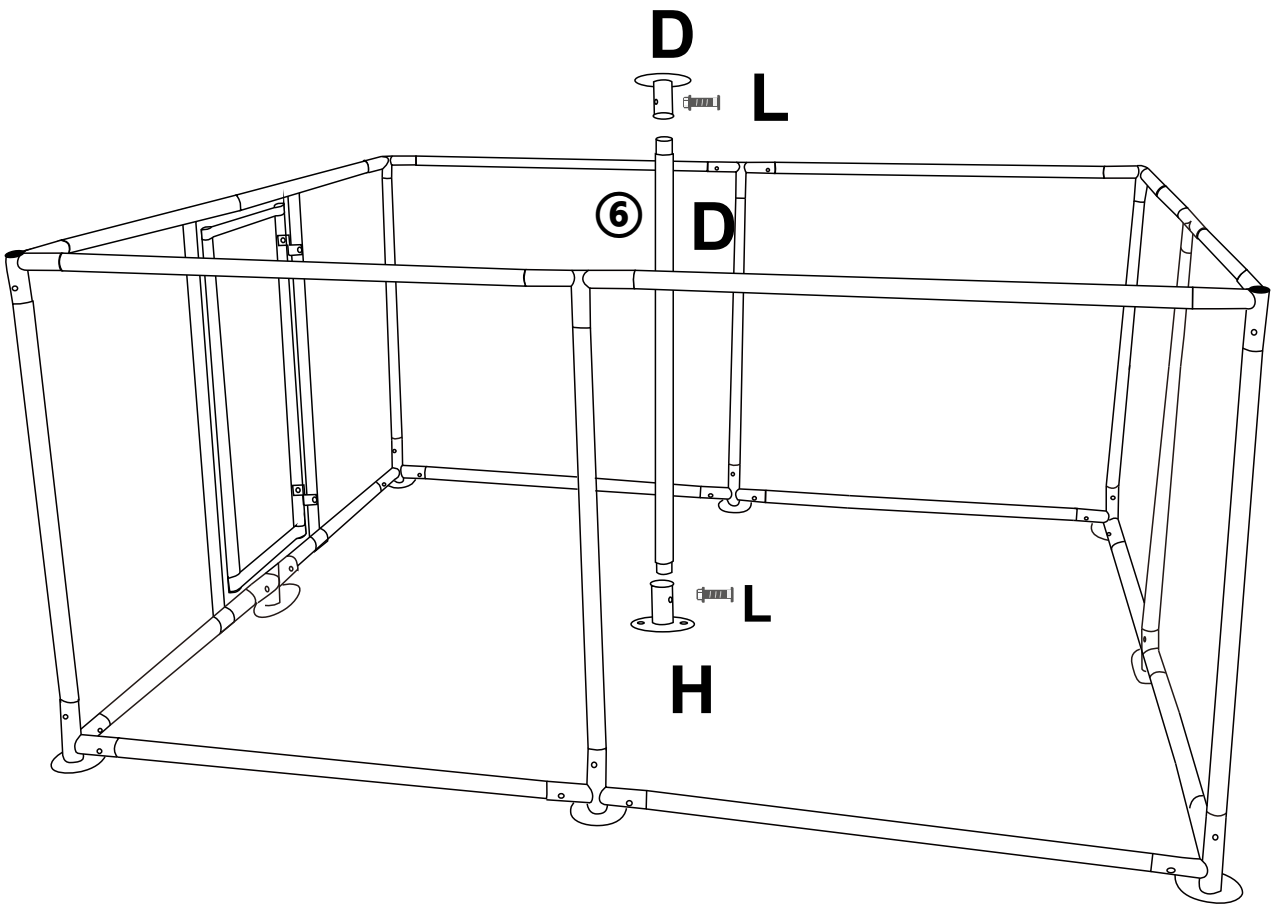

Required Tools	 ⑥ x1	 Lx2	 Dx1	 Hx1
----------------	--	---	---	---

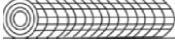

Required Tools	 Px1	 Qx1	 W2x4	 O
----------------	--	--	---	---

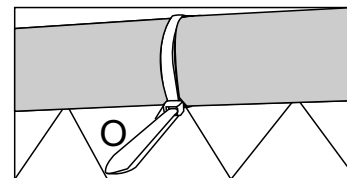

P

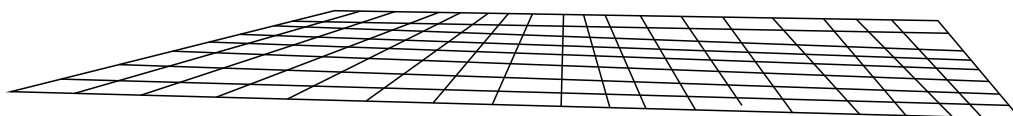

R

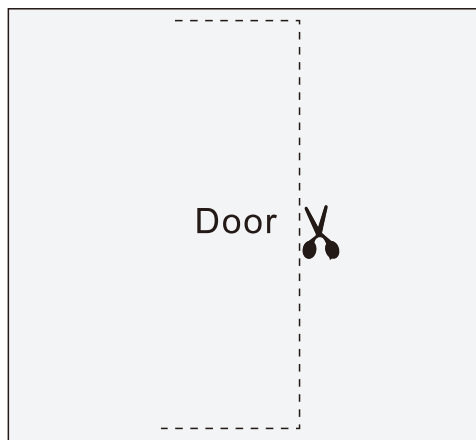
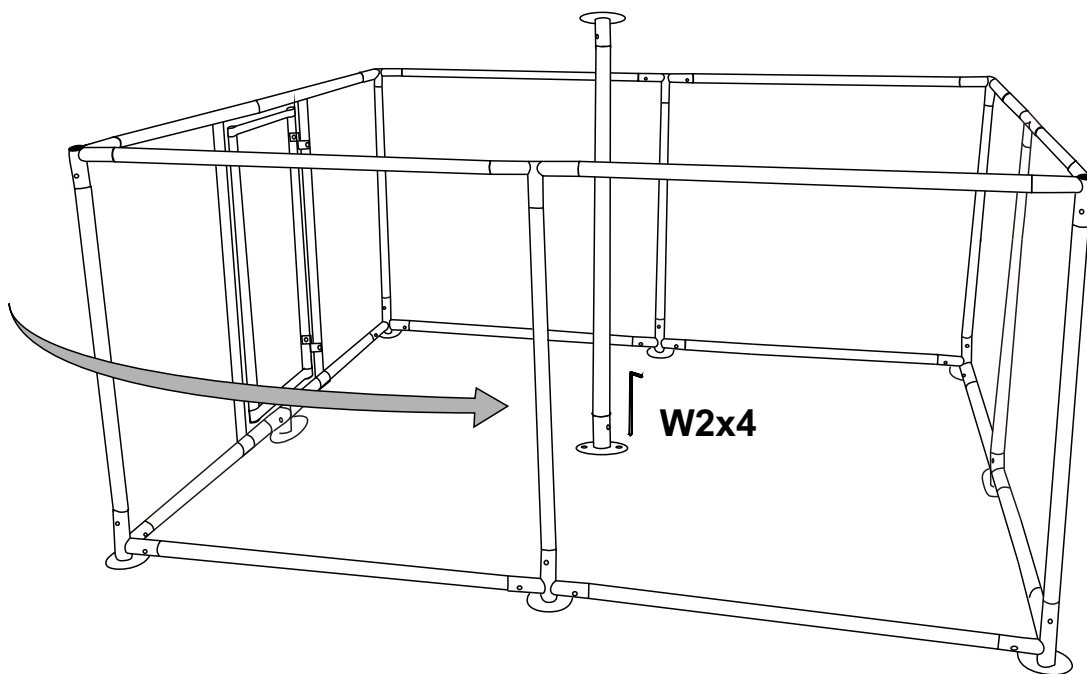
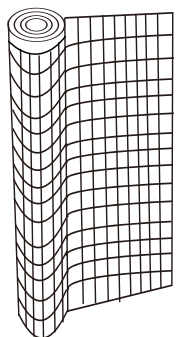

Required Tools	 W1x8
-------------------	---

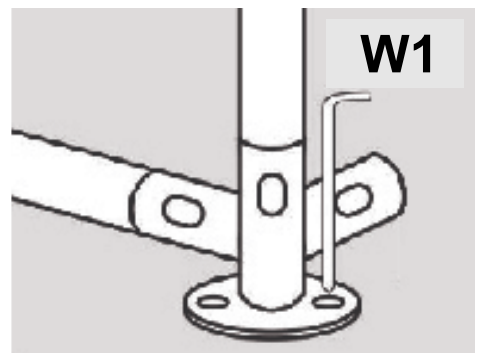
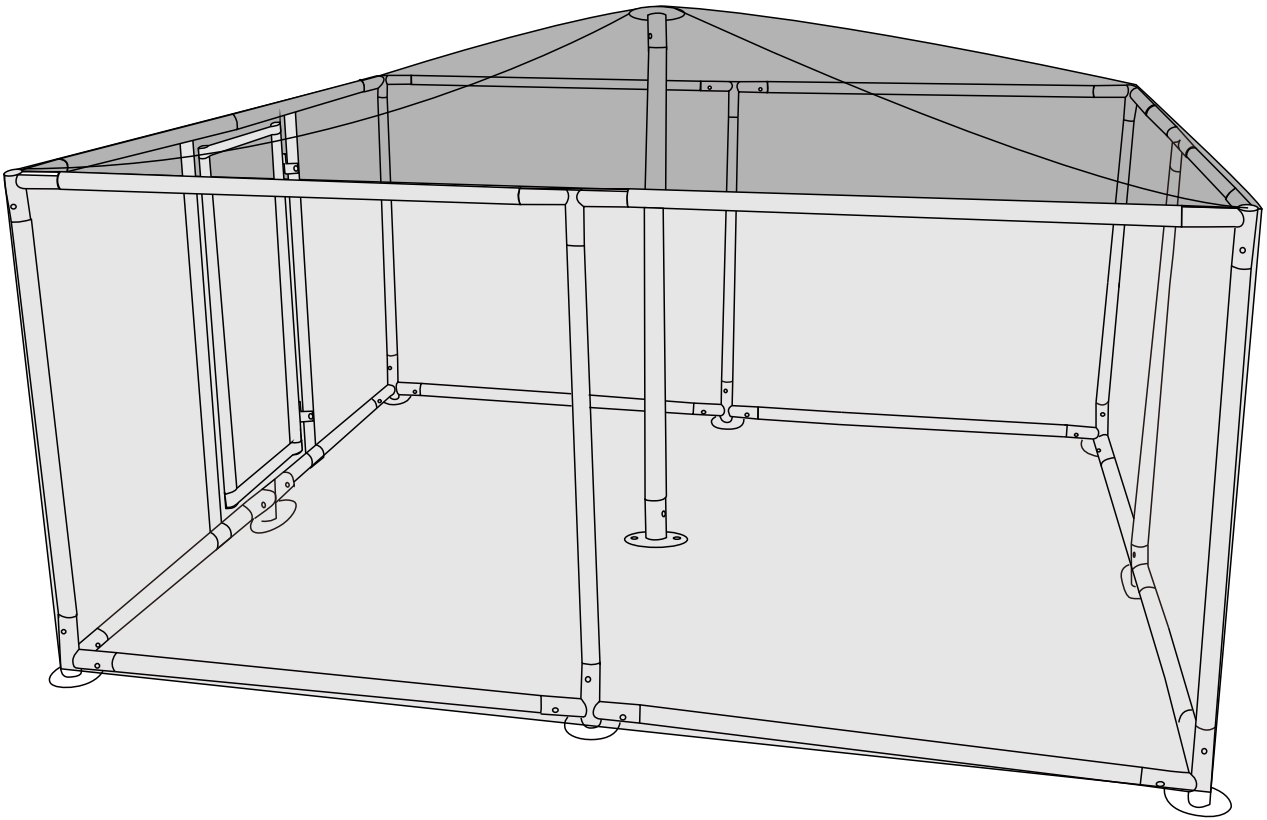

If you have any questions, please contact our customer care center, Our contact details are below:

**US**

 001-877-644-9366

 customerservice@aosom.com

Imported by Aosom LLC  
7777 Center Ave. Suite 430  
Huntington Beach, CA 92647-9998 USA  
MADE IN CHINA

If you have any questions, please contact our customer care center, Our contact details are below:

**CA**

 416-792-6088

 customerservice@aosom.ca

Imported by Aosom Canada Inc.  
7270 Woodbine Avenue, Unit 307, Markham,  
Ontario Canada L3R 4B9  
MADE IN CHINA

Si vous avez la moindre question, veuillez contacter notre centre d'assistance à la clientèle, Nos coordonnées sont les suivantes:

 416-792-6088

 customerservice@aosom.ca

Importé par Aosom Canada Inc.  
7270 Woodbine Avenue, unité 307,  
Markham, Ontario Canada L3R 4B9  
FABRIQUÉ EN CHINE

If you have any questions, please contact our customer care center, Our contact details are below:

**UK**

 0044-800-240-4004

 enquiries@mhstar.co.uk

IMPORTER ADDRESS:  
MH STAR UK Ltd  
1 Northampton Cross Logistics Park  
Northampton Cross Road  
Northampton  
NN4 9FH  
MADE IN CHINA

Si vous avez la moindre question, veuillez contacter notre centre d'assistance à la clientèle, Nos coordonnées sont les suivantes:

 0033-1-84166106

 aosom@mhfrance.fr

Importé par/Fabricant/REP:  
MH FRANCE  
2 Rue Maurice Hartmann  
92130 Issy Les Moulineaux  
France  
FABRIQUÉ EN CHINE

Si tiene alguna pregunta, comuníquese con nuestro Centro de Atención al Cliente, Nuestros datos de contacto son los siguientes:

**ES**

 0034-931294512

 atencioncliente@aosom.es

IMPORTADOR/Fabricante/REP:  
SPANISH AOSOM, S.L.  
C/ROC GROS,Nº15.08550, ELS HOSTALET DE  
BALENYÀ, SPAIN.  
B66295775  
HECHO EN CHINA

Se tiver alguma dúvida, por favor contacte o nosso Centro de Atendimento ao Cliente, Os nossos dados de contacto são os seguintes:

 0034-931294512

 info@aosom.pt.

IMPORTADOR/Fabricante/REP:  
SPANISH AOSOM, S.L.  
C.ROC GROS N.15, 08550. ELS HOSTALET DE  
BALENYÀ  
FEITO NA CHINA

In caso di dubbio, si prega di contattare il nostro centro assistenza clienti, I nostri dettagli di contatto sono di seguito:

**IT**

 0039-0249471447

 clienti@aosom.it

IMPORTATO DA/Produttore/REP:  
AOSOM Italy srl  
Centro Direzionale Milanofiori  
Strada 1 Palazzo F1  
20057 Assago (MI)  
P.I.: 08567220960  
FATTO IN CINA

Wenn Sie Fragen haben, wenden Sie sich bitte an unser Kundendienstzentrum, Unsere Kontaktdaten stehen unten:

**DE**

 0049-0(40)-87408465

 service@aosom.de

ADRESSE DES IMPORTEURE/Hersteller/REP:  
MH Handel GmbH  
Wendenstraße 309  
D-20537 Hamburg  
Germany  
IN CHINA HERGESTELLT

Si vous avez la moindre question, veuillez contacter notre centre d'assistance à la clientèle, Nos coordonnées sont les suivantes:

 0033-1-84166106

 aosom@mhfrance.fr

Importé par/Fabricant/REP:  
MH FRANCE  
2 Rue Maurice Hartmann  
92130 Issy Les Moulineaux  
France  
FABRIQUÉ EN CHINE



**FR**

**DONNEZ  
OU  
RECYCLEZ**



ASSOCIATION

OU



LIVRAISON

OU



DÉCHÈTERIE

Adresses sur [quefairedemesdechets.fr](http://quefairedemesdechets.fr)

**FR**