

EN_ IMPORTANT, RETAIN FOR FUTURE REFERENCE: READ CAREFULLY.

FR_ IMPORTANT: A LIRE ATTENTIVEMENT ET À CONSERVER POUR CONSULTATION ULTÉRIEURE.

ES_ IMPORTANTE, LEA Y GUARDE PARA FUTURAS REFERENCIAS.

PT_ IMPORTANTE: LEIA ATENTAMENTE E GUARDE PARA CONSULTA FUTURA.

DE_ WICHTIG! SORGFÄLTIG LESEN UND FÜR SPÄTER NACHSCHLAGEN AUFBEWAHREN.

IT_ IMPORTANTE! CONSERVARE IL PRESENTE MANUALE PER FUTURO RIFERIMENTO E LEGGERLO ATTENTAMENTE.

RO_ IMPORTANT: CITIȚI CU ATENȚIE ȘI PĂSTRAȚI PENTRU CONSULTARE VIITOARE.



EN_ QUICKFIT: Tighten quickfit until shoulder is flush with panel. Do not overtighten or undertighten.

FR_ RACCORD RAPIDE: Faites serrer le raccord rapide jusqu'à ce que l'épaulement soit parfaitement encastré dans le panneau. Il ne faut ni trop serrer ni insuffisamment serrer.

ES_ QUICKFIT: Apriete quickfit hasta que el hombro se descargue con el panel. NO lo sobreapriete ni lo apriete poco.

PT_ AJUSTE RÁPIDO: Aperte o ajuste rápido até estar nivelada com o painel. Não apertar demasiado ou excessivamente.

DE_ QUICKFIT: Ziehen Sie den Quickfit fest, bis die Schulter mit der Platte bündig ist. Bitte nicht zu fest oder zu schwach anziehen.

IT_ MONTAGGIO RAPIDO: Stringere il montaggio rapido fino a quando la spalla è a filo con il pannello, non stringere troppo o troppo poco.

RO_ QUICKFIT: Strângeți quickfit până când umărul este la același nivel cu panoul. Nu strângeți prea tare și nici prea slab.



EN_ CAM LOCK: When fitting cam lock, ensure starting position is correct before you insert connecting quickfit.

FR_ SERRURE BATTEUSE: Avant d'insérer la serrure batteuse, veillez à la bonne orientation avant d'insérer le raccord rapide.

ES_ CIERRE DE LA CÁMARA: Cuando instale el cierre de la cámara, asegúrese de que la posición de inicio es correcta antes de que inserte el quickfit conector.

PT_ BLOQUEIO: Ao instalar o bloqueio, assegurar-se de que a posição inicial está correcta antes de inserir o encaixe de ligação rápida.

DE_ CAM-LOCK: Achten Sie bei der Montage des Cam-Locks auf die richtige Ausgangsposition, bevor Sie den Quickfit einsetzen.

IT_ BLOCCAGGIO A CAMMA: Quando si monta il bloccaggio a camma, assicurarsi che la posizione iniziale sia corretta prima di inserire il montaggio rapido di collegamento.

RO_ BLOCARE CU CAME: Când montați blocarea cu came, asigurați-vă că poziția inițială este corectă înainte de a introduce racordul rapid.

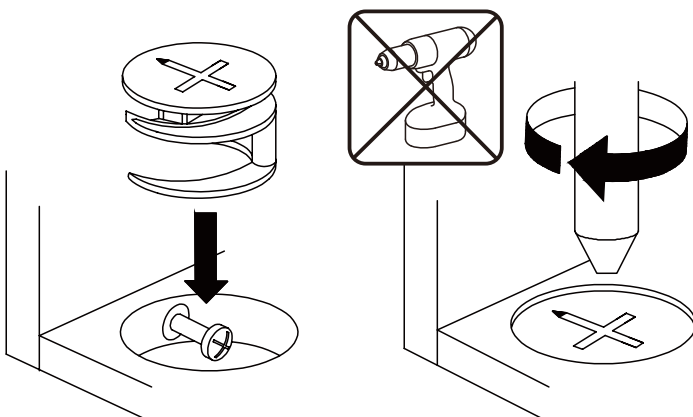

EN_ Turn cam lock clockwise to tighten.

FR_ Faites tourner la serrure batteuse dans le sens des aiguilles d'une montre pour la resserrer.

ES_ Gire el cierre de la cámara en sentido horario para apretarlo.

PT_ Rodar o bloqueio no sentido dos ponteiros do relógio para o apertar.

DE_ Drehen Sie den Cam-Lock im Uhrzeigersinn, um ihn festzuziehen.

IT_ Ruotare il bloccaggio a camma in senso orario per stringere.

RO_ Rotiți blocarea cu came în sensul acelor de ceasornic pentru a strânge.

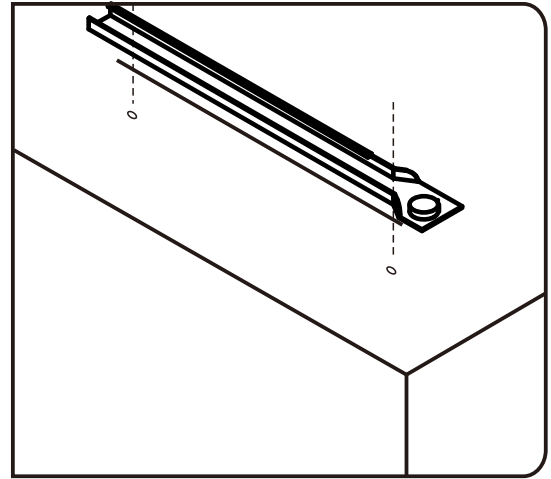
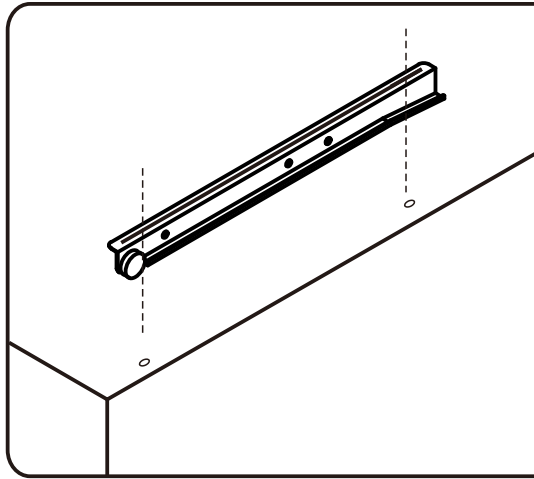
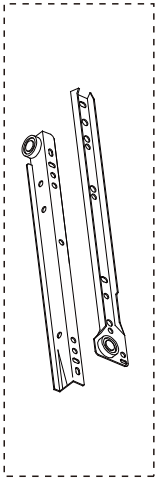

EN_ Please find the exact hole for installation, otherwise it will be misaligned. The screws on the drawer slide must be leveled, otherwise it will affect the smoothness of the drawer.

FR_ Identifiez le trou exact pour l'installation, sinon il sera mal aligné. Les vis de la glissière du tiroir doivent être nivelées, sinon cela affectera le fonctionnement du tiroir.

ES_ Al instalar, encuentre el orificio exacto; de lo contrario, estará desalineado. Los tornillos en las correderas del cajón deben estar nivelados, de lo contrario, afectará la suavidad al deslizar el cajón.

PT_ Por favor encontre o orifício exacto para instalação, caso contrário será desalinhado. Os parafusos na corredeira da gaveta devem ser nivelados, caso contrário afetará a suavidade da abertura da gaveta.

DE_ Bitte finden Sie das genaue Loch für die Installation, sonst wird es falsch ausgerichtet werden. Die Schrauben an der Schubladenführung müssen nivelliert werden, da sonst die Leichtgängigkeit der Schublade beeinträchtigt wird.

IT_ individuare il foro esatto per l'installazione, altrimenti ci sarà un disallineamento. Le viti sulla guida del cassetto devono essere allineate, altrimenti influirà sulla scorrevolezza del cassetto.

RO_ Găsiți orificiul exact pentru instalare, altfel acesta va fi aliniat incorect. Șuruburile de pe glisiera sertarului trebuie să fie nivelate, altfel aceasta va afecta funcționarea lină a sertarului.

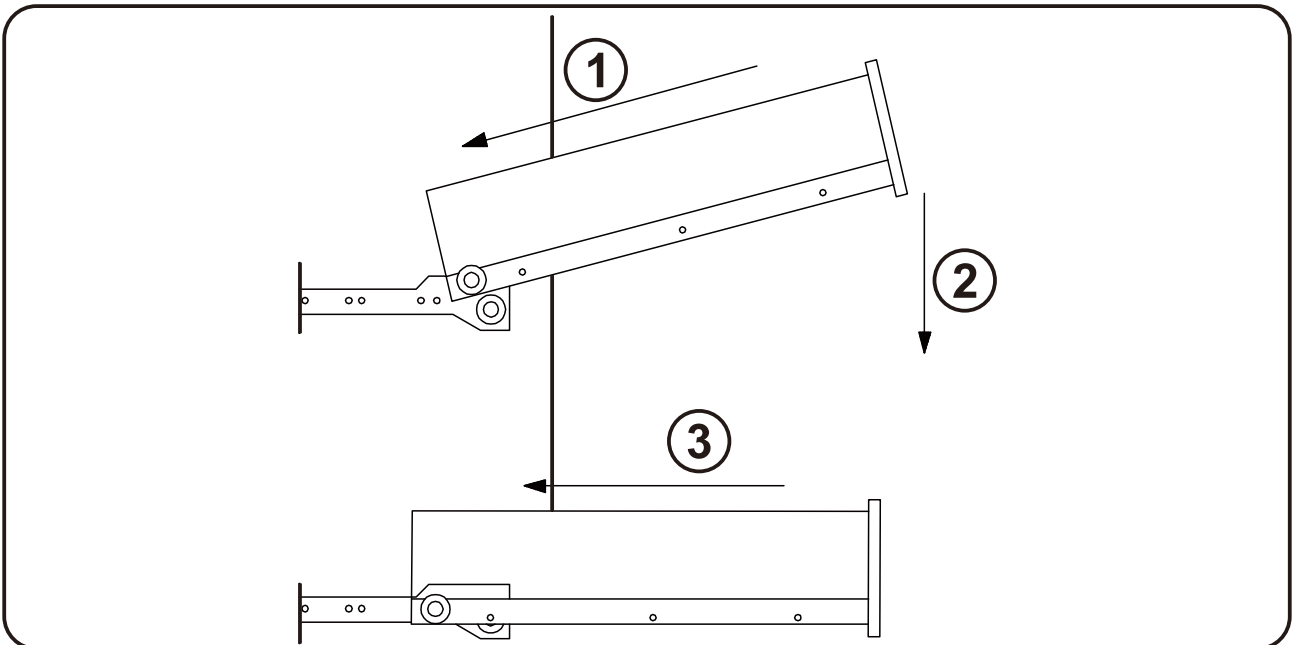

EN_ Be careful to push in the board when the both sides slide way been aligned.

FR_ Prenez soin d'enfoncer la planche lorsque les deux côtés de la glissière sont alignés.

ES_ Empuje con cuidado el tablero después de que los dos lados se hayan alineado.

PT_ Ter o cuidado de empurrar a placa quando os dois lados estiverem alinhados.

DE_ Achten Sie darauf, dass Sie die Platte einschieben, wenn die beiden Seiten so ausgerichtet sind, dass sie gleiten.

IT_ Fare attenzione quando si spinge il cassetto quando le due guide di scorrimento sono state allineate.

RO_ Aveți grijă să împingeți placa atunci când ambele părți sunt aliniate.

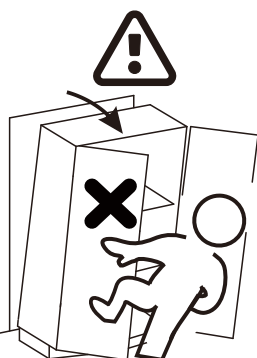
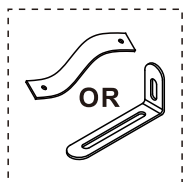

EN_ This is anti-dumping belt that fix the product to the wall and it can be used or not follow your needs.

FR_ Cette sangle anti-basculement permet de fixer le produit au mur. Elle peut être utilisée ou non selon vos besoins.

ES_ Esta es una correa anti-vuelco para fijar el producto a la pared, y según sus necesidades, puede utilizarla o no.

PT_ Este é o sistema anti-tombo que fixa o produto à parede e pode ser usado para uma maior segurança.

DE_ Dies ist Anti-Sturz-Gurt, um das Gerät an der Wand zu befestigen und es kann je nach Bedarf verwendet oder nicht verwendet werden.

IT_ Questa è una cintura anticaduta che fissa il prodotto alla parete e può essere utilizzata o meno a seconda delle vostre esigenze.

RO_ Aceasta este o centură anti-dumping care fixează produsul pe perete și poate fi utilizată sau nu, în funcție de necesități.

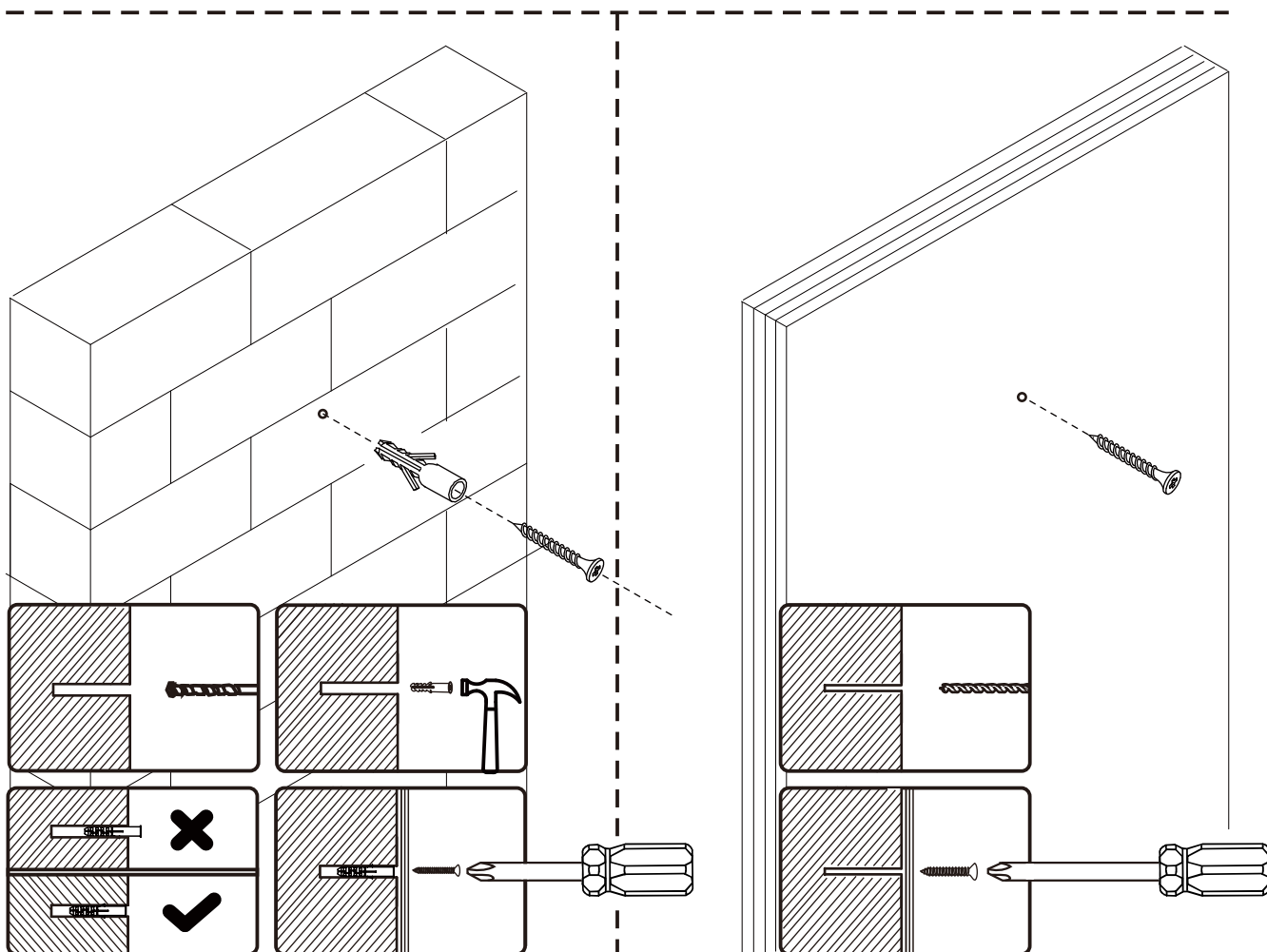

EN_ If it is a solid wall, please use expansion and self-tapping screws, if it is a wooden wall, only use self-tapping screws, please do not overtighten the screws

FR_ Si le mur est massif, veuillez utiliser des chevilles à expansion et des vis autotaraudeuses, mais s'il s'agit d'un mur en bois, utilisez uniquement des vis autotaraudeuses et ne serrez pas trop les vis.

ES_ Para una pared sólida, utilice los tornillos de expansión y autorroscantes. Para una pared de madera, utilice exclusivamente los tornillos autorroscantes, no los apriete demasiado.

PT_ Se for uma parede sólida, use por favor parafusos de expansão e auto-roscantes, se for uma parede de madeira, use apenas parafusos auto-roscantes, por favor não aperte demasiado os parafusos.

DE_ Wenn es sich um eine Massivwand handelt, verwenden Sie bitte Dehnungs- und selbstschneidende Schrauben. Wenn es sich um eine Holzwand handelt, verwenden Sie nur selbstschneidende Schrauben, bitte ziehen Sie die Schrauben nicht zu fest an.

IT_ Se si tratta di un muro solido, utilizzare sia viti ad espansione che autofilettanti. Se si tratta di una parete in legno, utilizzare solo viti autofilettanti, non stringere eccessivamente le viti.

RO_ Dacă este un perete solid, vă rugăm să utilizați șuruburi cu expansiune și autofiletante, dacă este un perete din lemn, utilizați numai șuruburi autofiletante, vă rugăm să nu strângeți excesiv șuruburile.

PARTS LIST

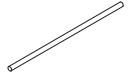
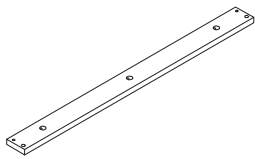
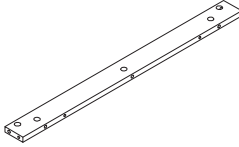
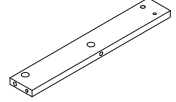
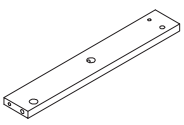
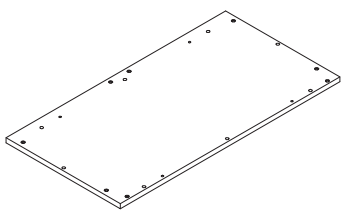
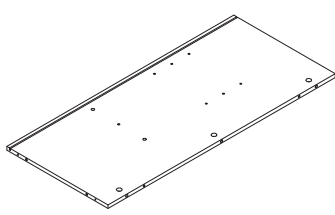
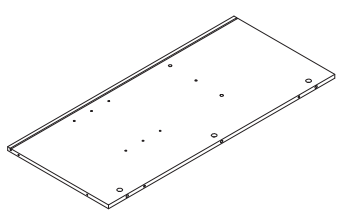
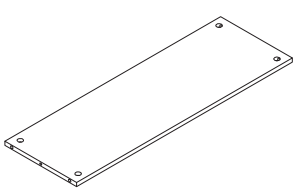
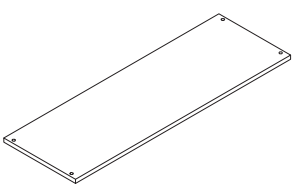
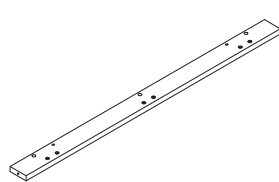
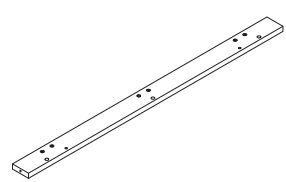
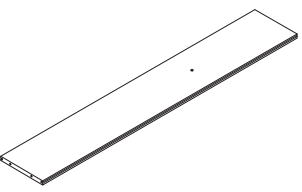
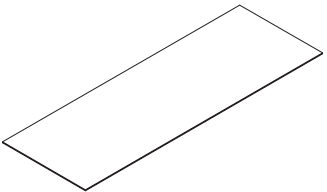
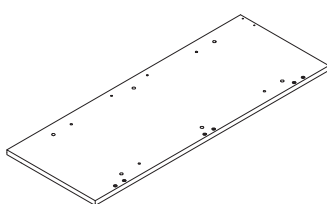
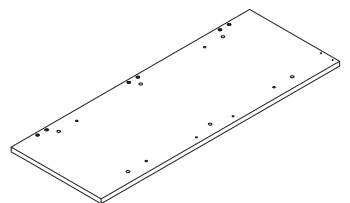
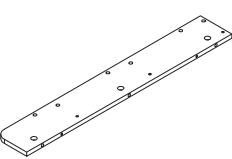
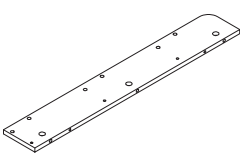
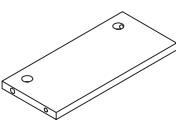
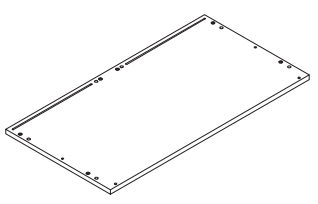
<p>① 6PCS</p> 	<p>② 2PCS</p> 	<p>③ 2PCS</p> 	<p>④ 2PCS</p> 
<p>⑤ 2PCS</p> 	<p>⑥ 1PC</p> 	<p>⑦ 1PC</p> 	<p>⑧ 1PC</p> 
<p>⑨ 1PC</p> 	<p>⑩ 1PC</p> 	<p>⑪ 1PC</p> 	<p>⑫ 1PC</p> 
<p>⑬ 1PC</p> 	<p>⑭ 2PCS</p> 	<p>⑮ 1PC</p> 	<p>⑯ 1PC</p> 
<p>⑰ 2PCS</p> 	<p>⑱ 2PCS</p> 	<p>⑲ 6PCS</p> 	<p>⑳ 1PC</p> 

PARTS LIST

21 1PC

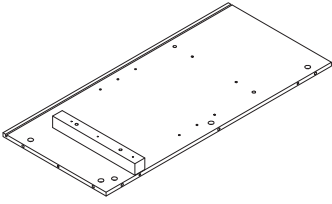

22 1PC

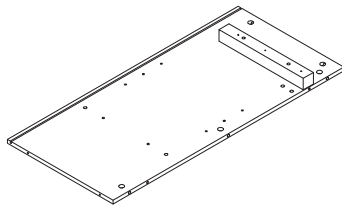

23 1PC

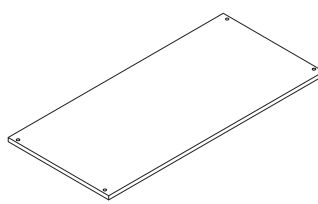

24 1PC

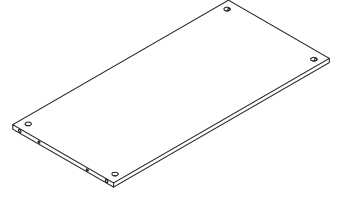

25 1PC

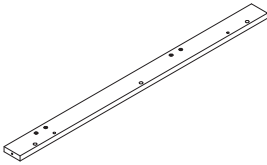

26 1PC

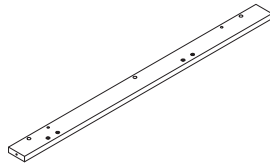

27 1PC

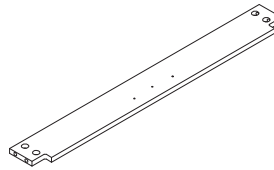

28 1PC

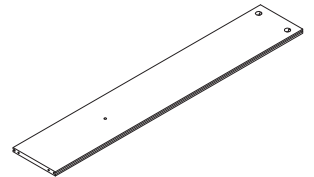

29 2PCS

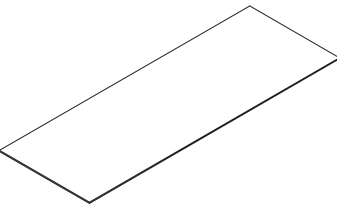

30 1PC

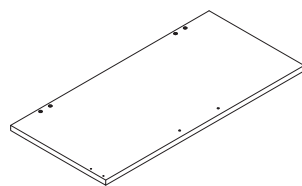

31 1PC

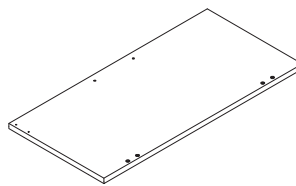

32 1PC

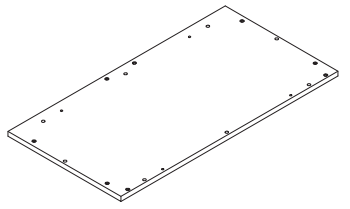

33 1PC

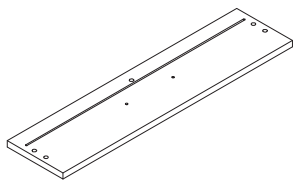

34 1PC

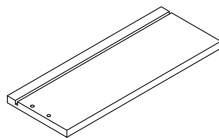

35 1PC

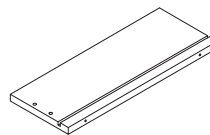

36 1PC

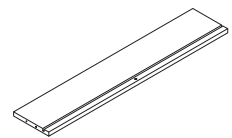



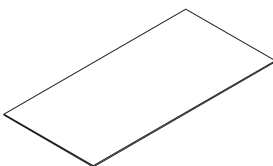



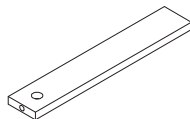









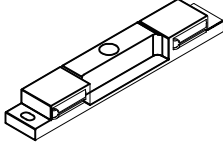
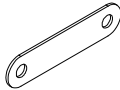
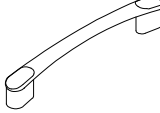

37 1PC

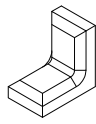
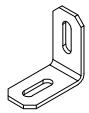

38 1PC

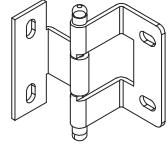

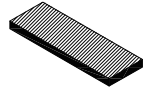
HARDWARE LIST

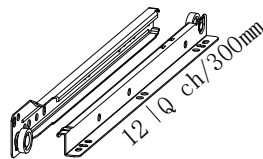
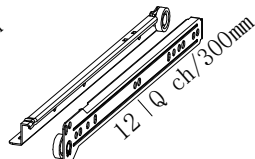
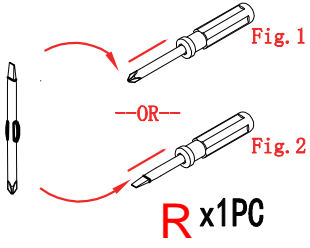
 M4 Ax1PC	 M5*46mm Bx24PCS	 6*30mm Cx56PCS	 6*M3*12mm Dx20PCS	 Ex8PCS
 6.5*36mm F1x83PCS	 15*9.8mm F2x83PCS	 14*14*11mm G1x16PCS	 6*M3*16mm G2x22PCS	 H1x2PCS
 H2x4PCS	 I1x5PCS	 I2x10PCS	 28x28x18mm J1x2PCS	 26x26x13.5mm J2x2PCS
 6x25mm K1x2PCS	 M4 K2x2PCS	 8xM4x25mm K3x2PCS	 Lx10PCS	 6*50mm Mx2PCS
 Nx40PCS	 30*10*2mm Ox8PCS	 8xM4x30mm Px5PCS	Q1 (CL) x1PC	Q2 (DR) x1PC
			 Q1 (DL) x1PC	 Q2 (CR) x1PC
 Rx1PC				

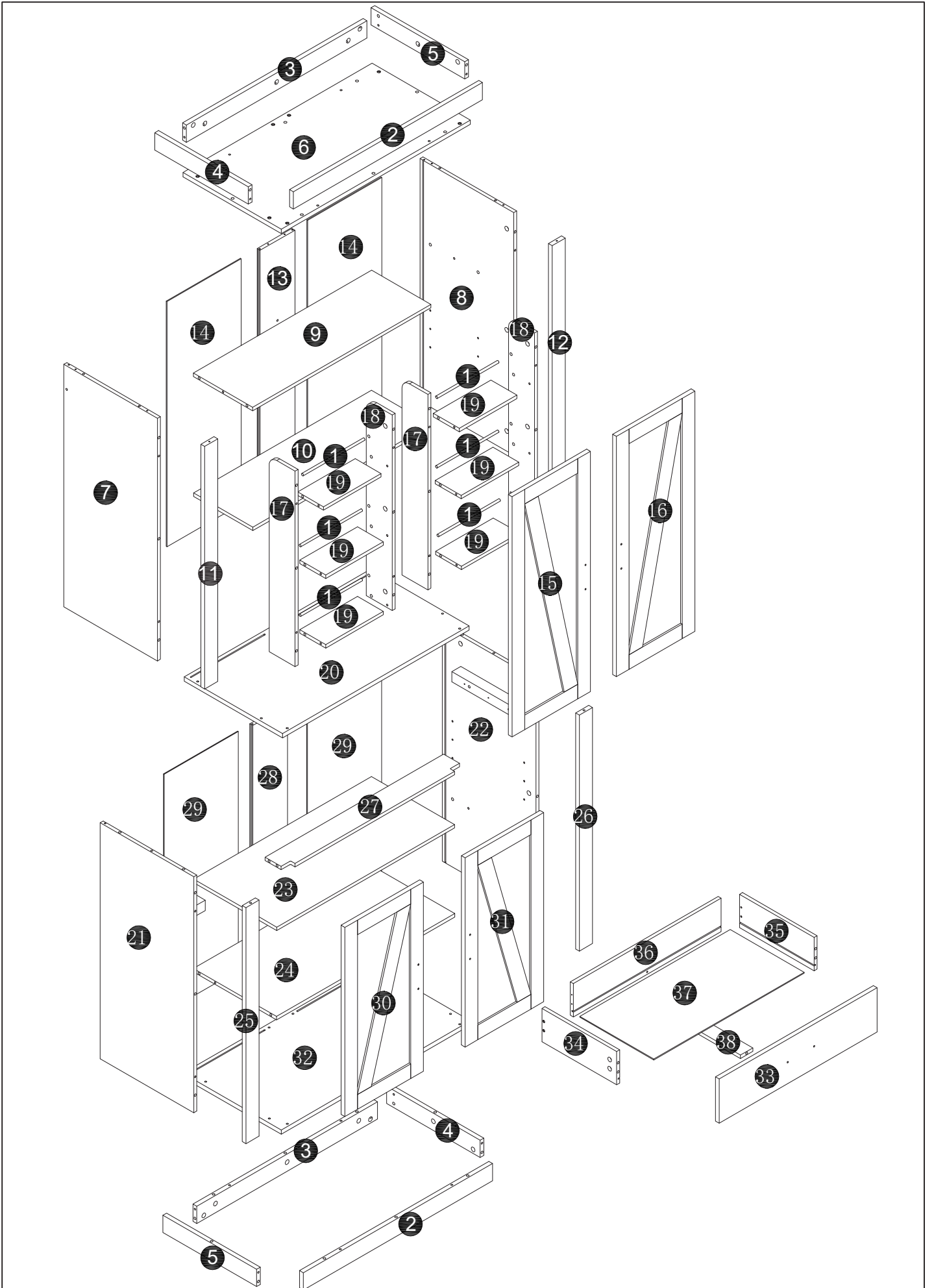

1

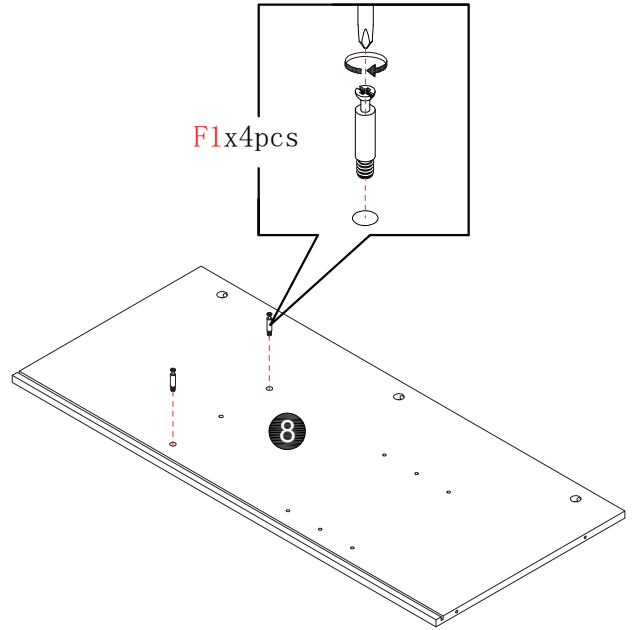
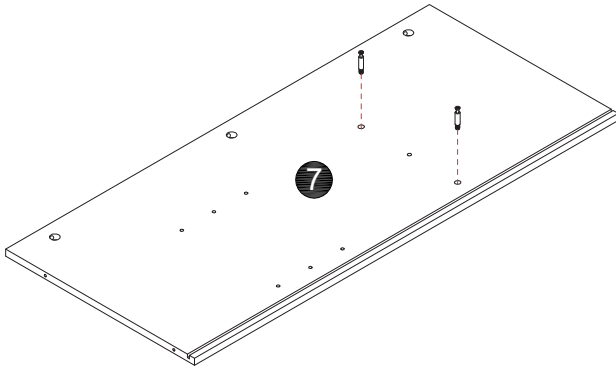
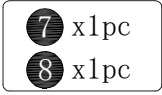
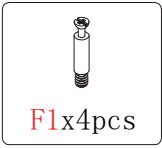

2

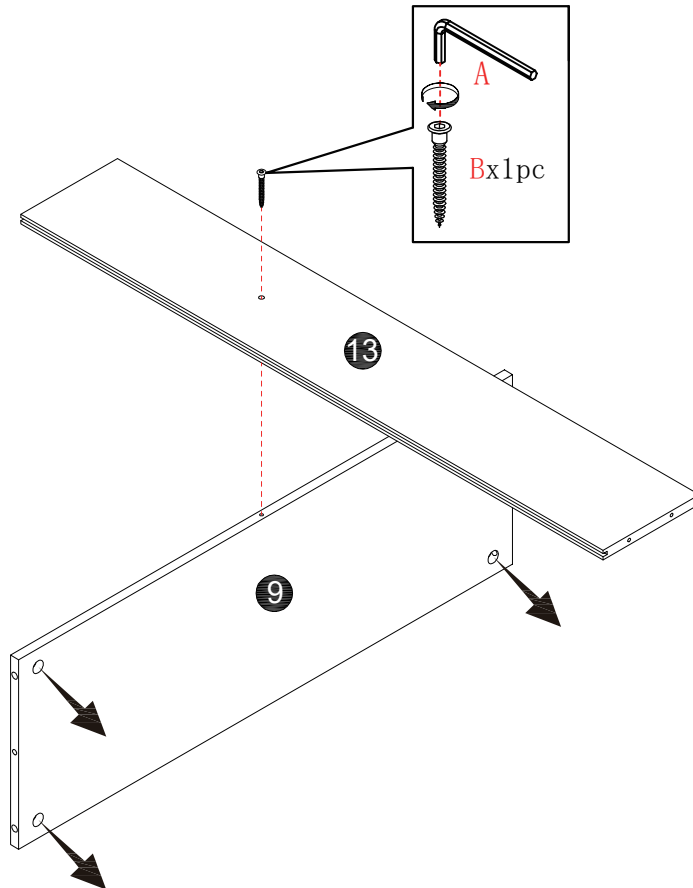
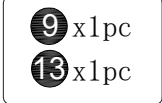
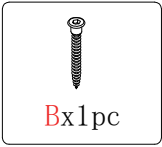

3

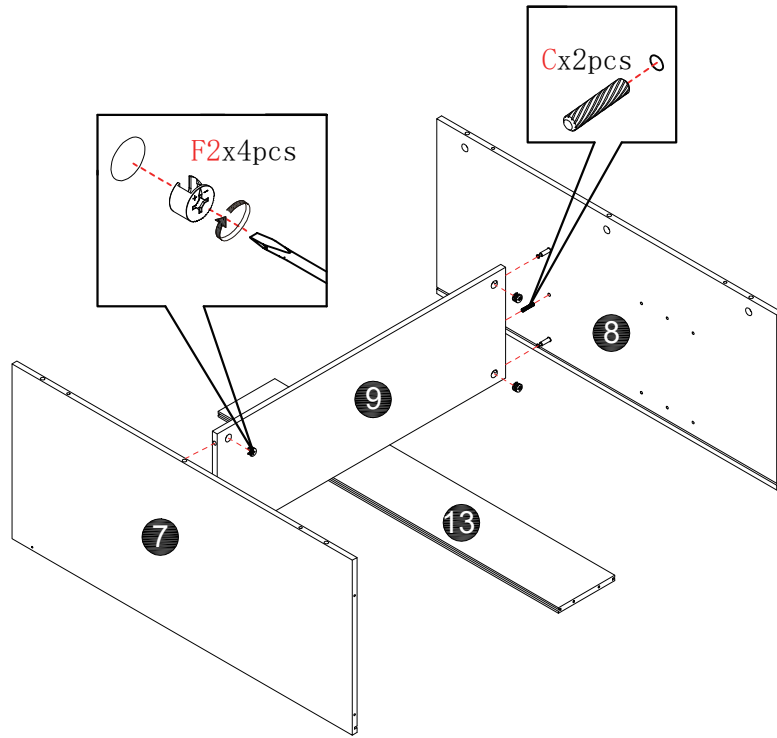
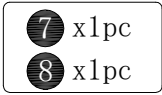
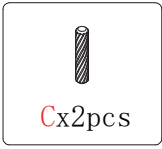
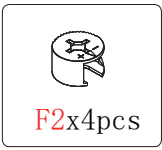

4

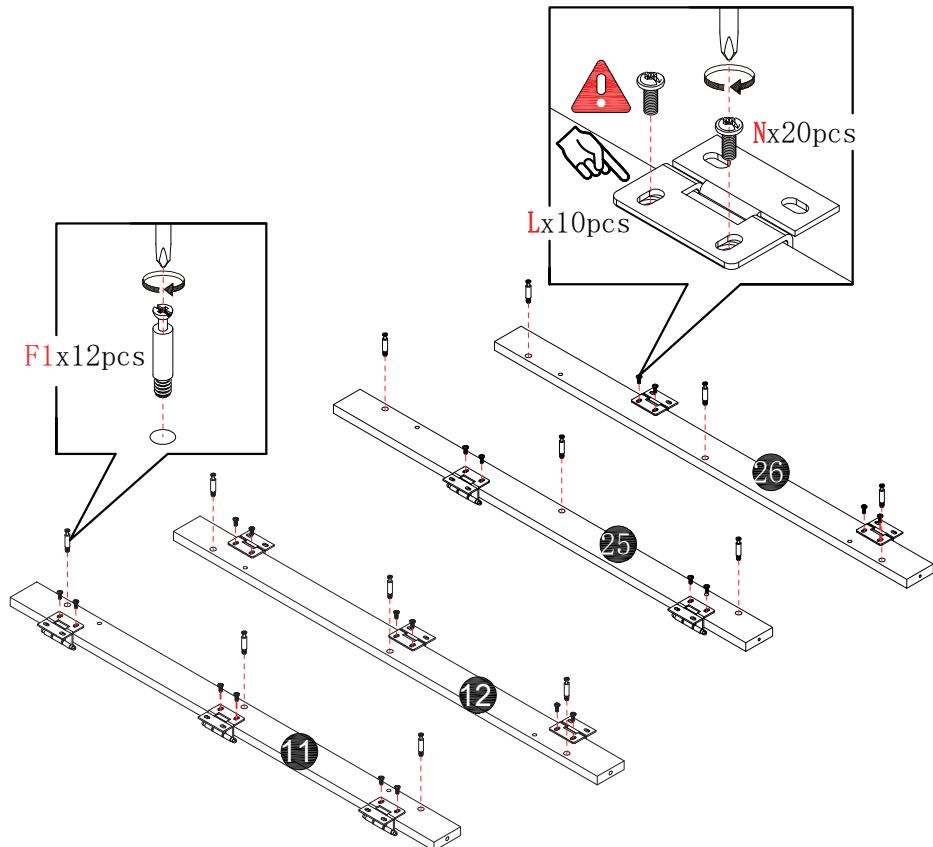
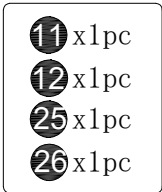
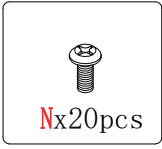
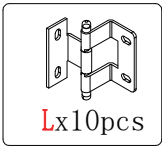
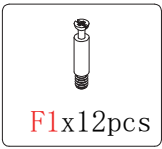

5

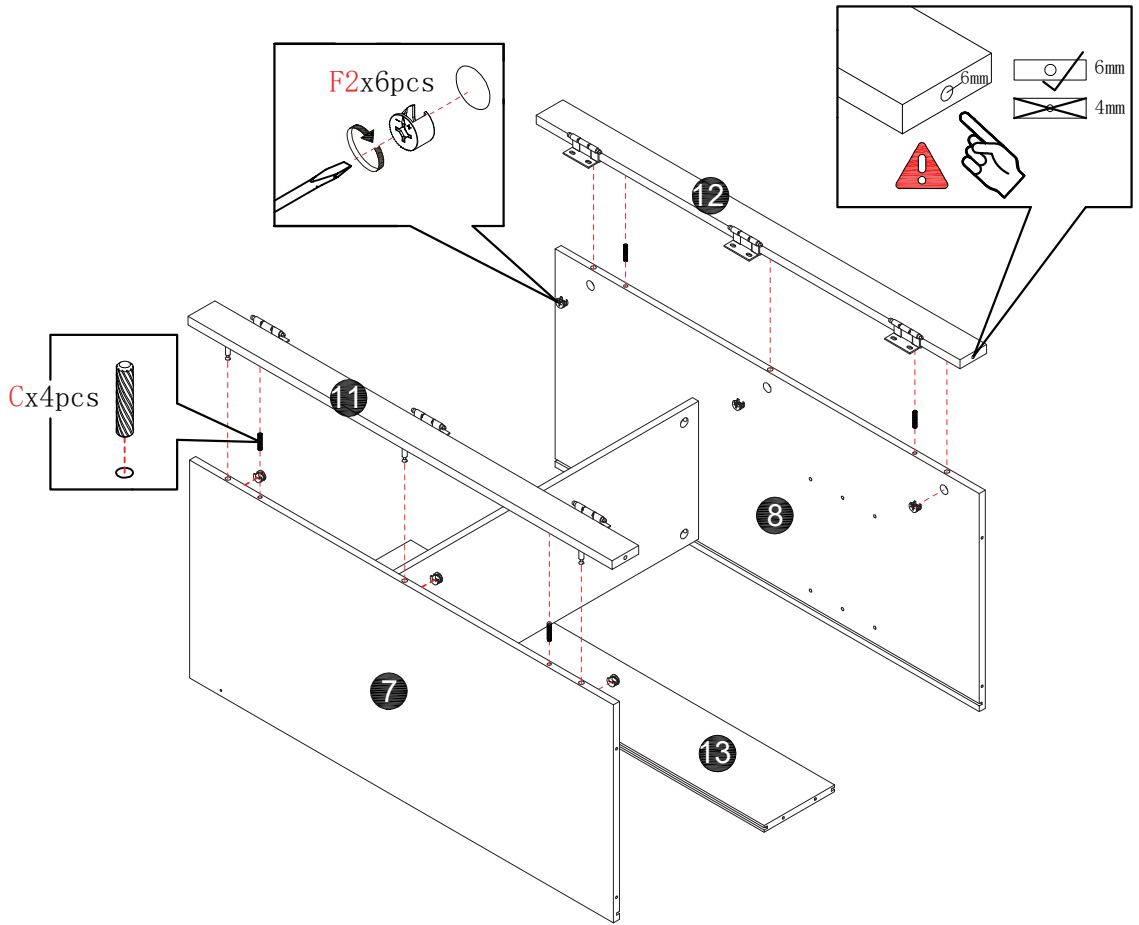
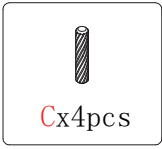
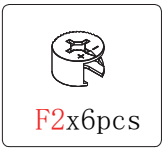

6

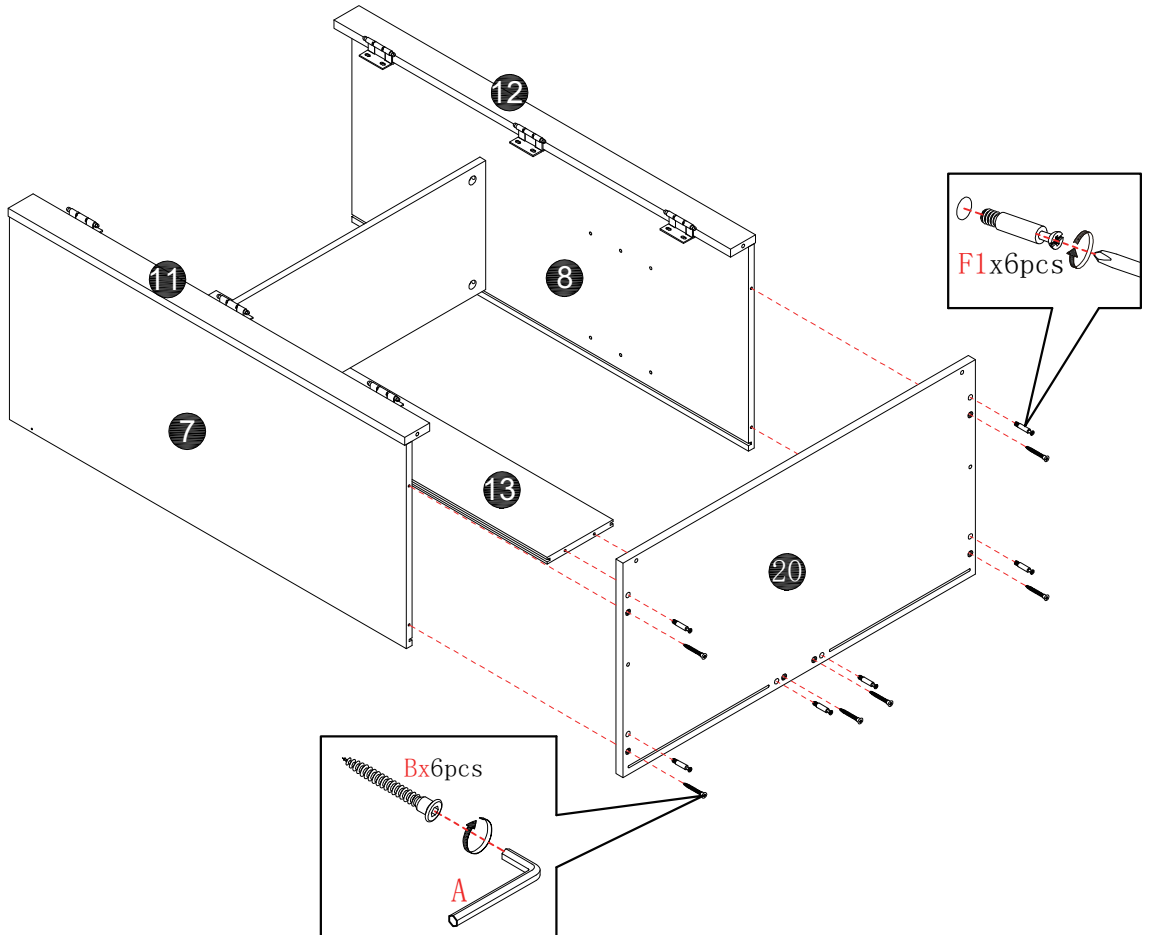
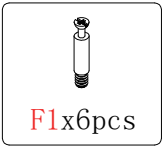
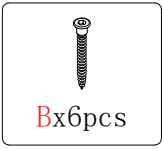

7

14 x2pcs

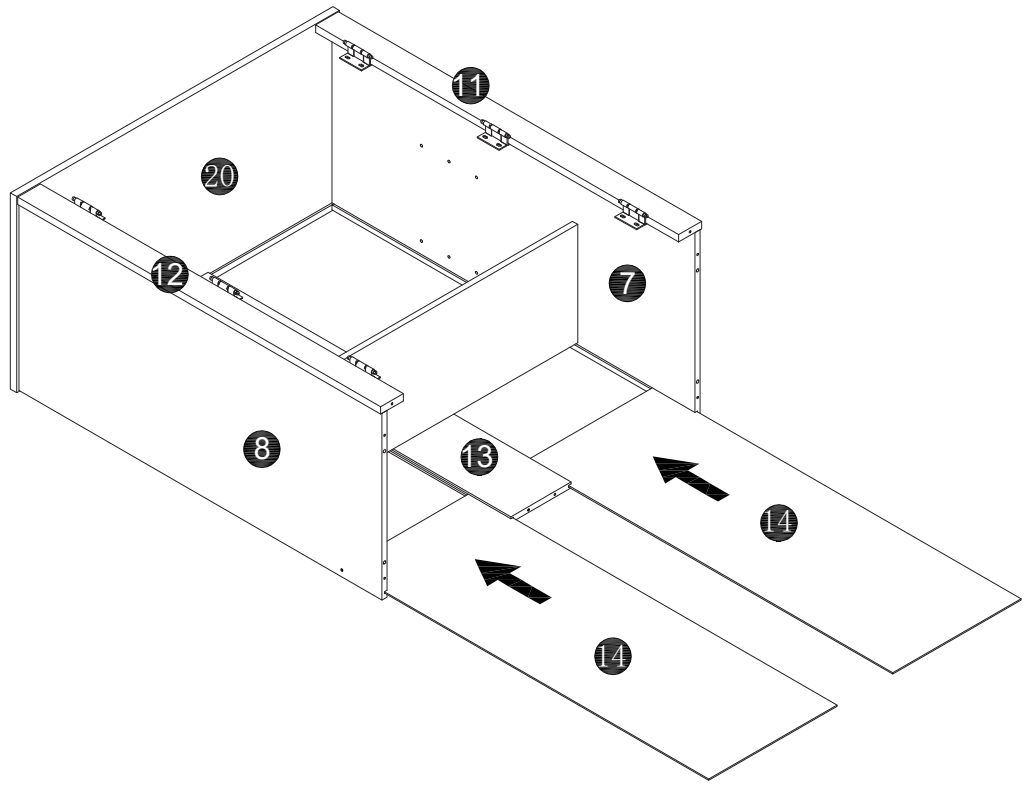

8

G2 x3pcs

H1 x1pc

6 x1pc

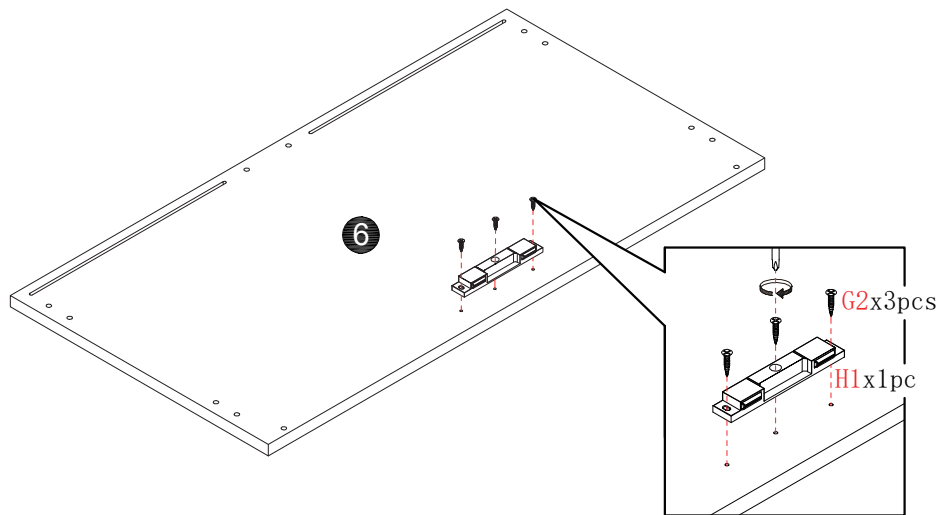

9

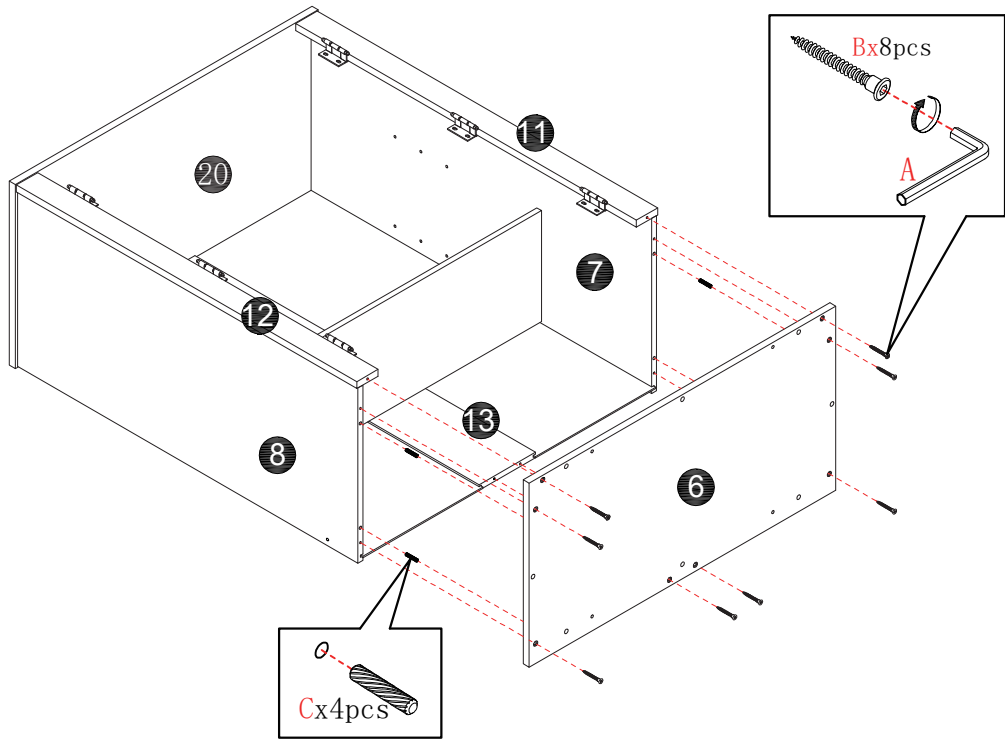
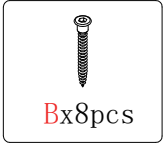
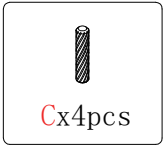

10

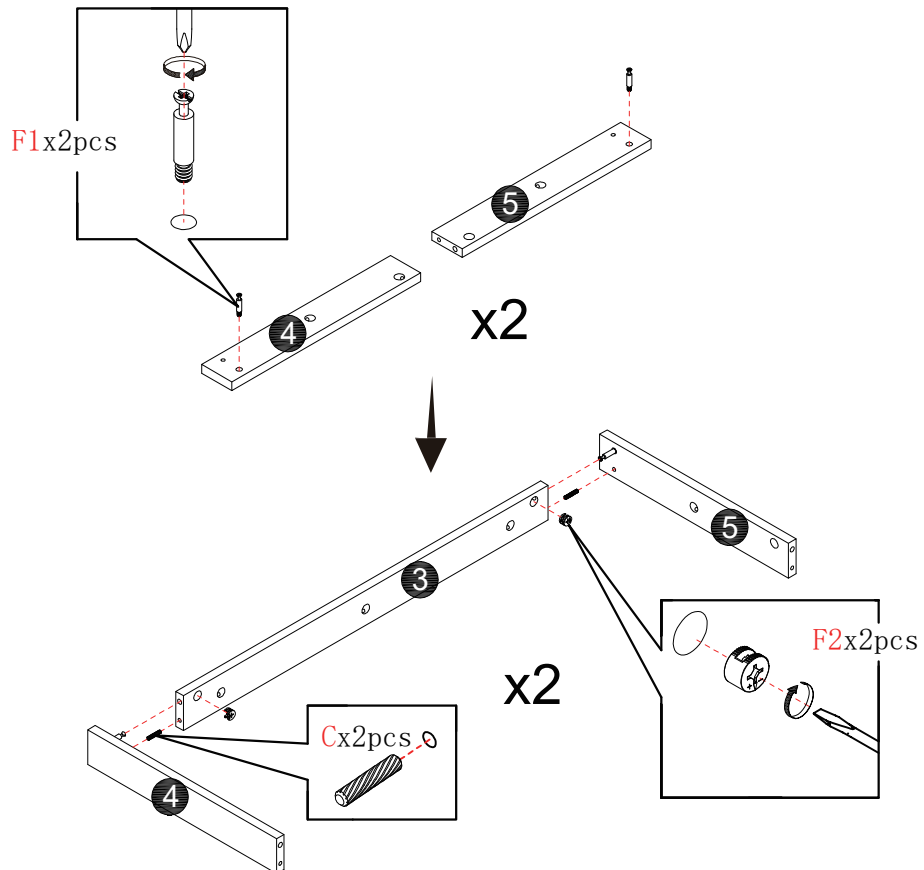
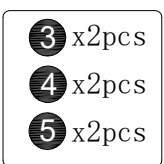
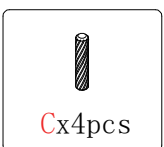
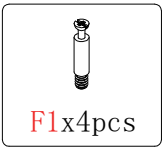

11

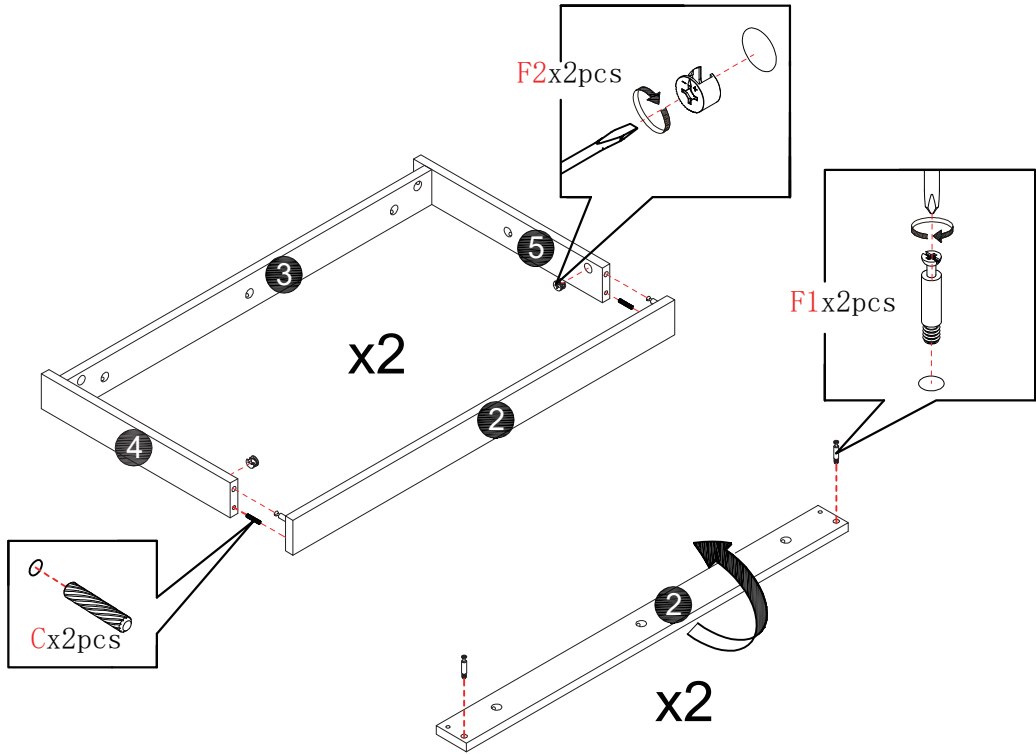
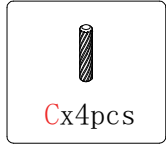
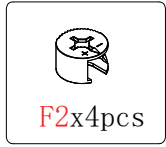
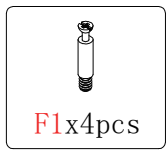

12

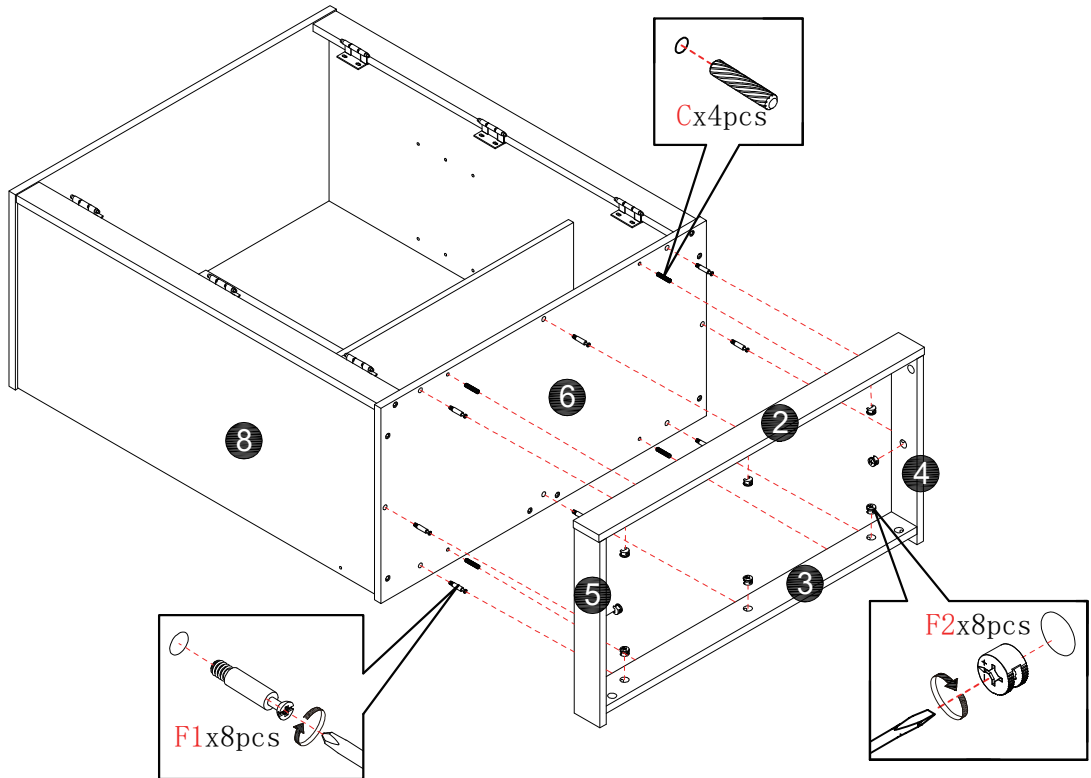
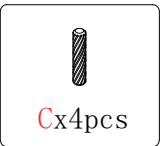
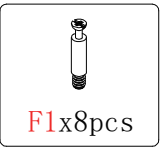

13

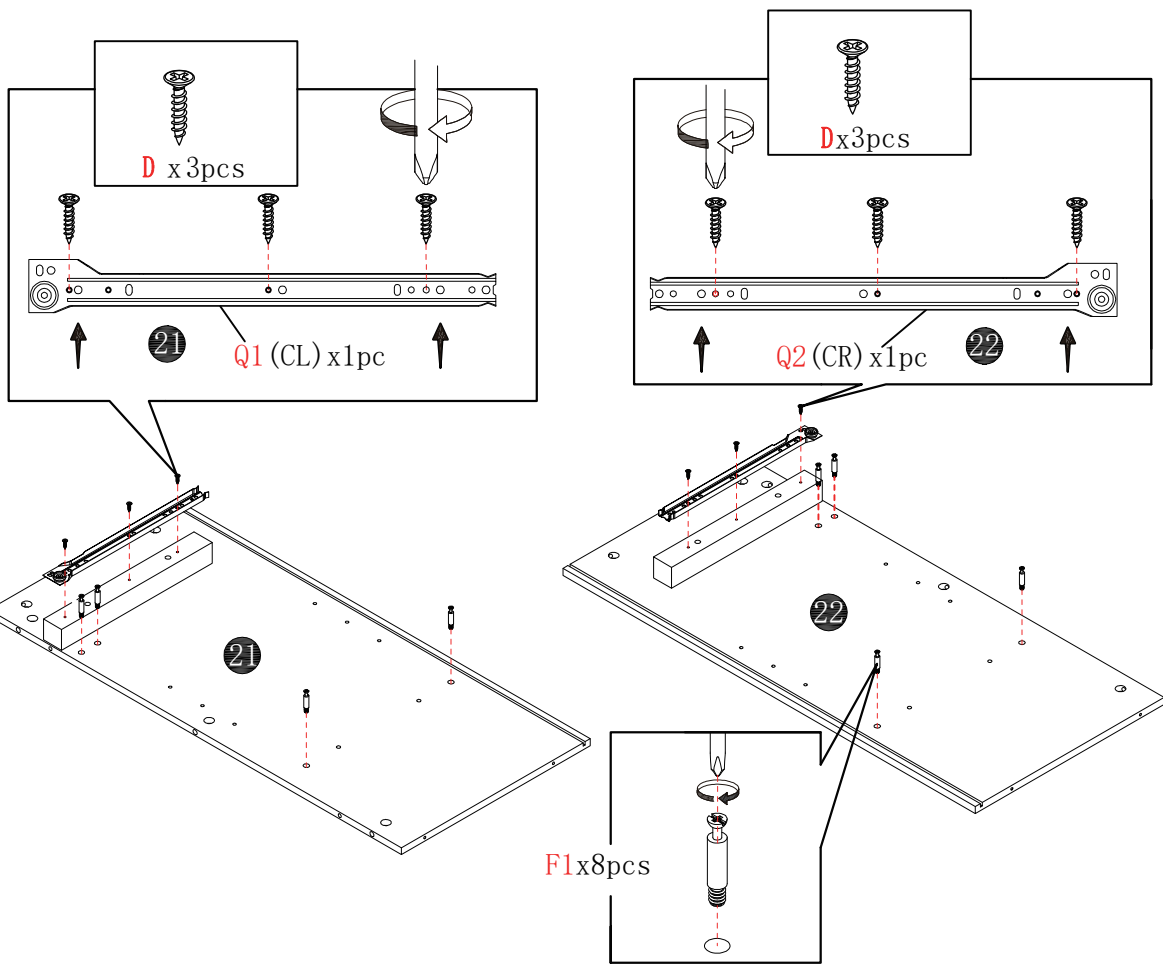
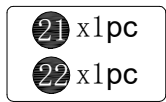
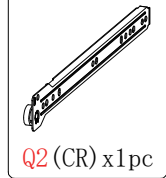
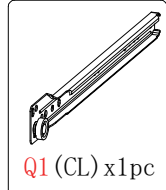
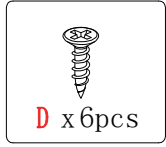
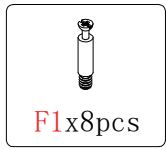

14

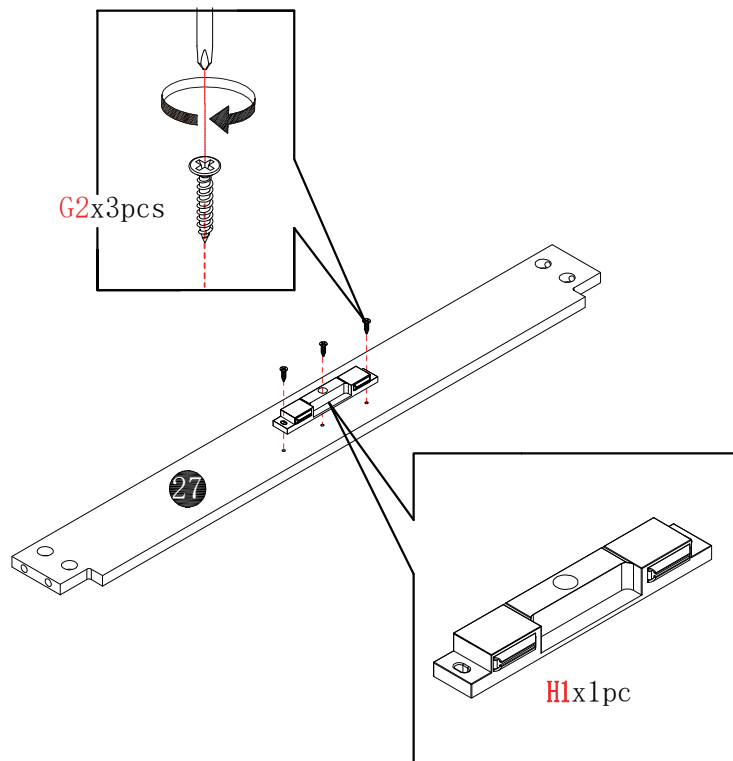
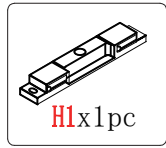

15

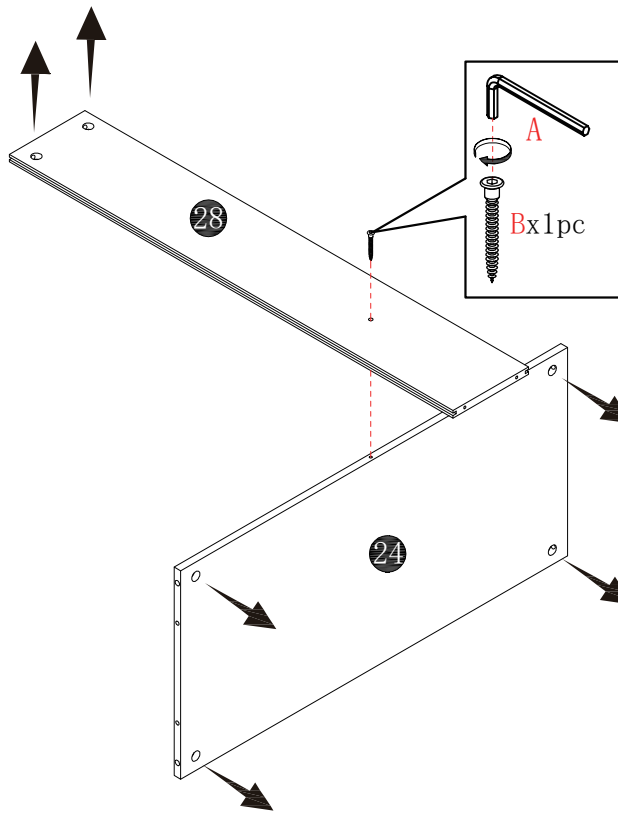
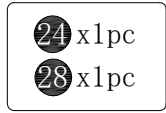
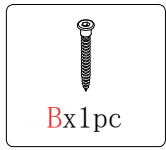

16

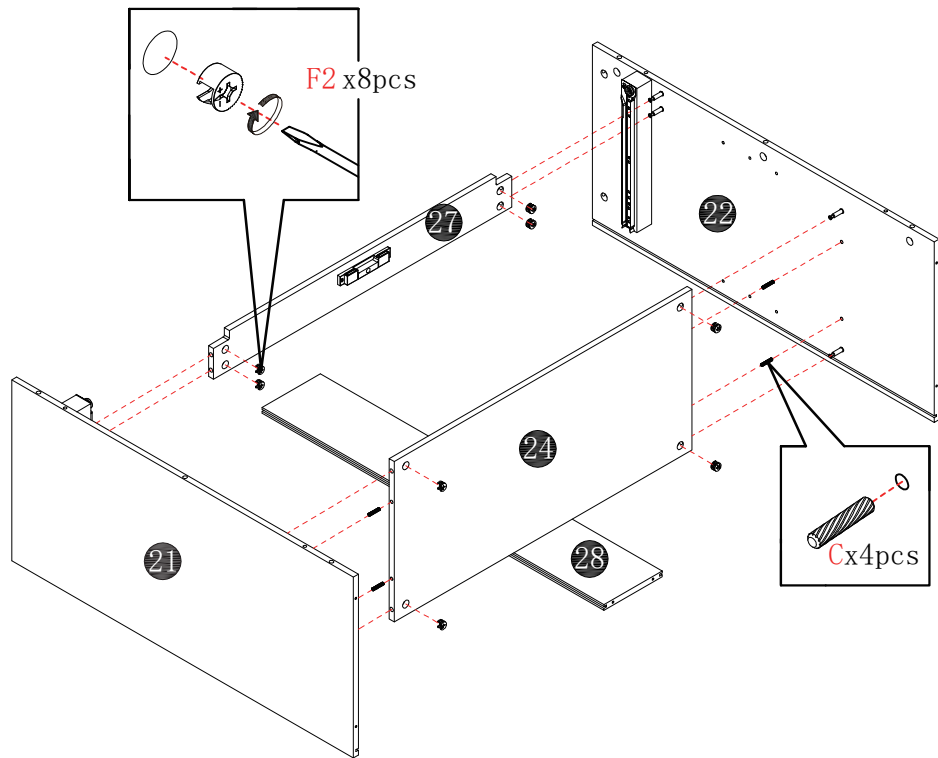
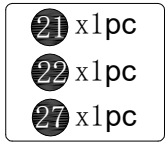
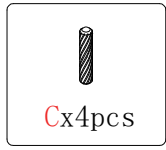

17

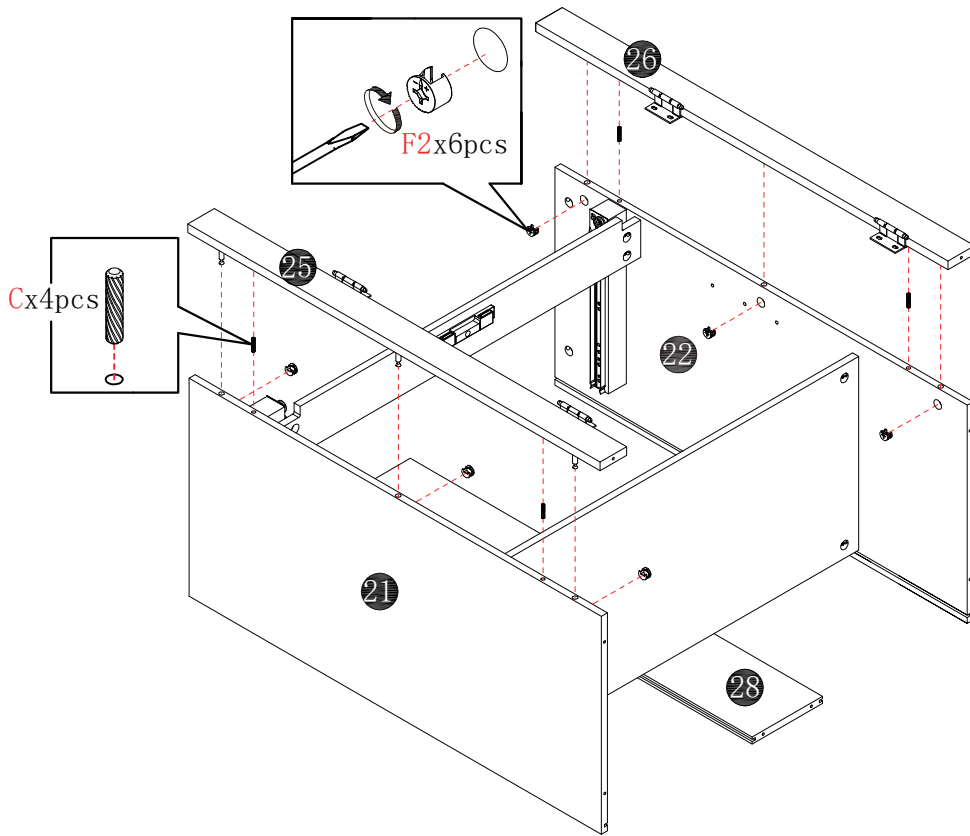
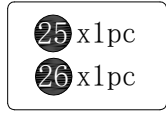
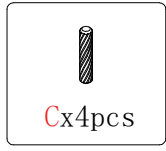
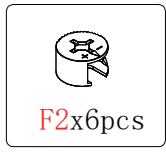

18

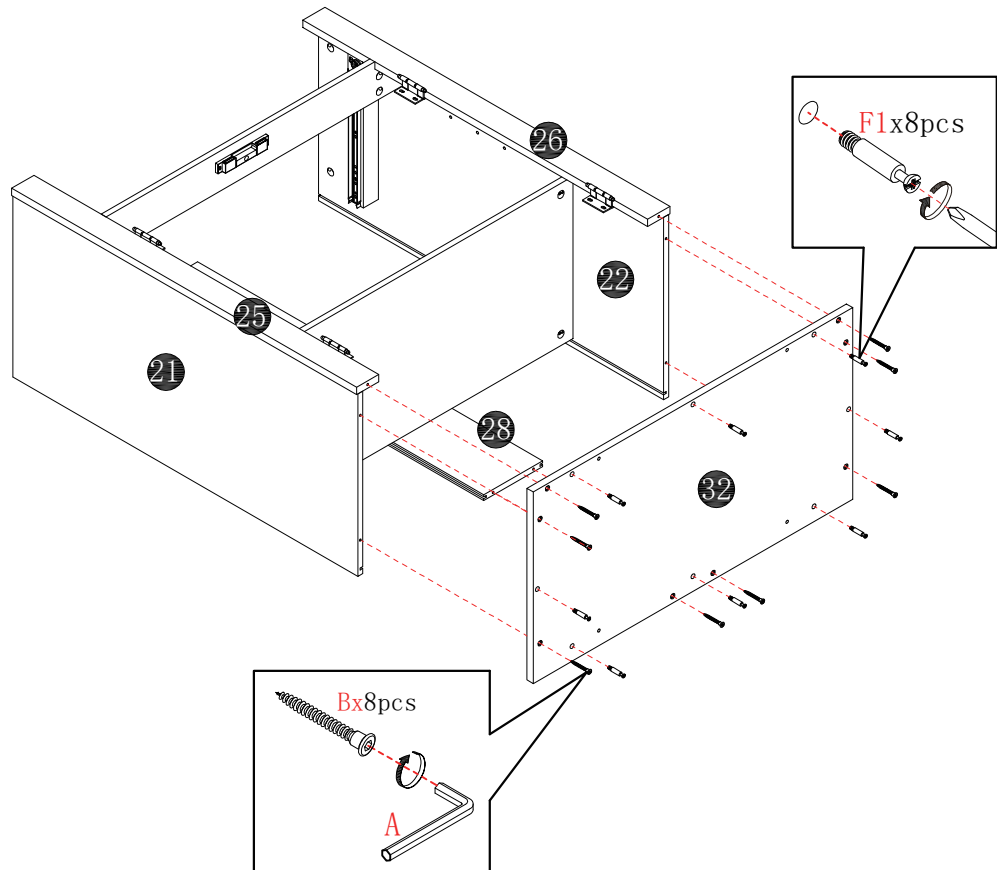
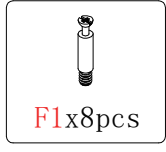
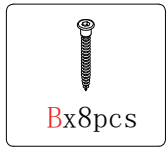

19

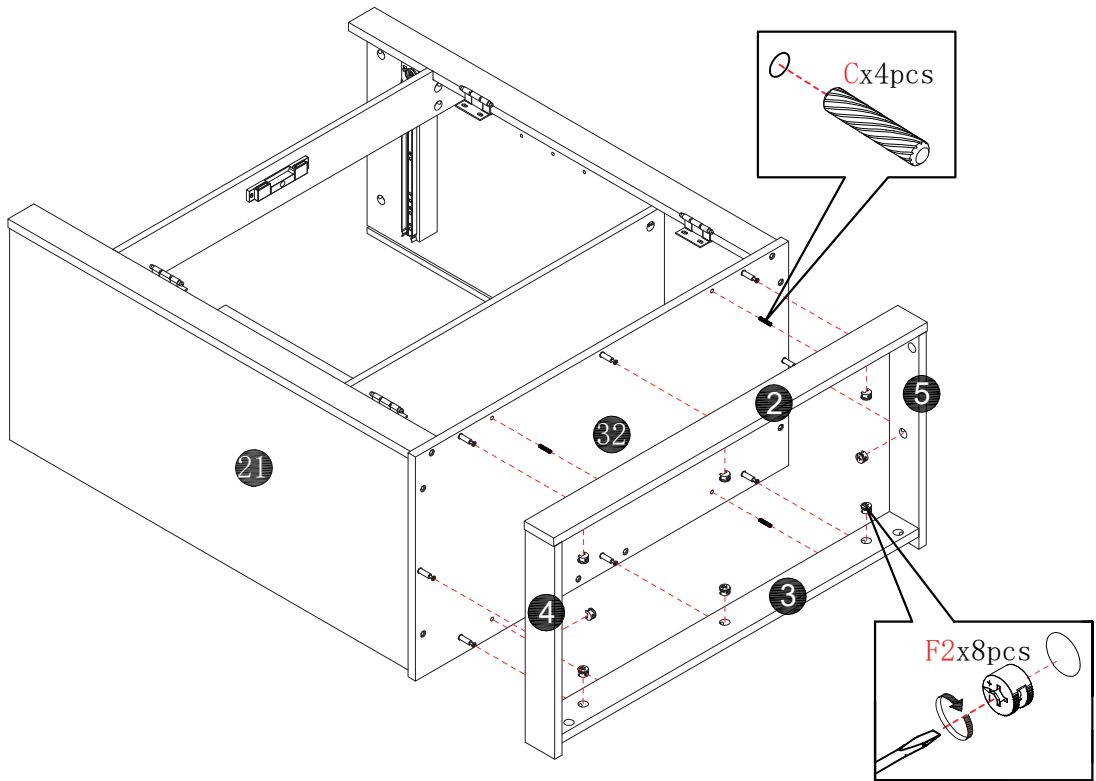
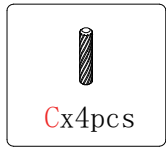

20

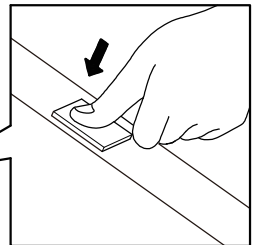
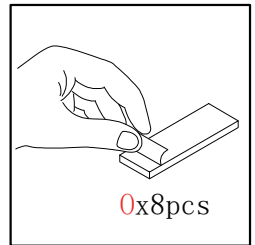
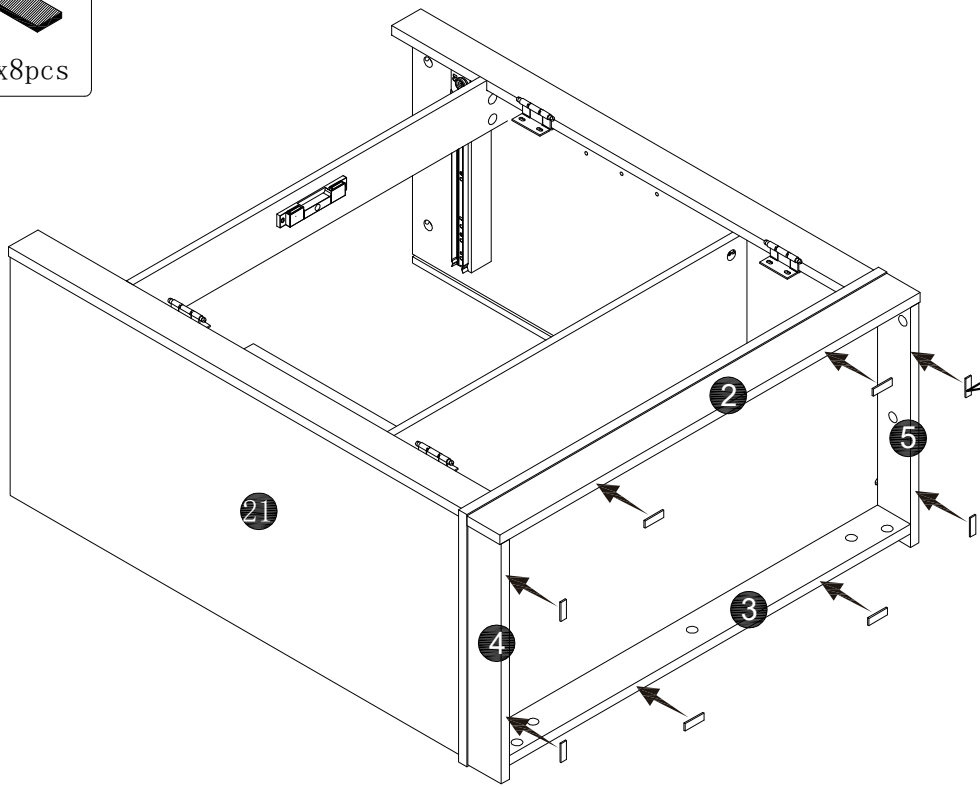
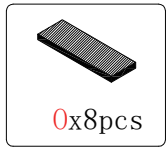

21

29 x2pcs

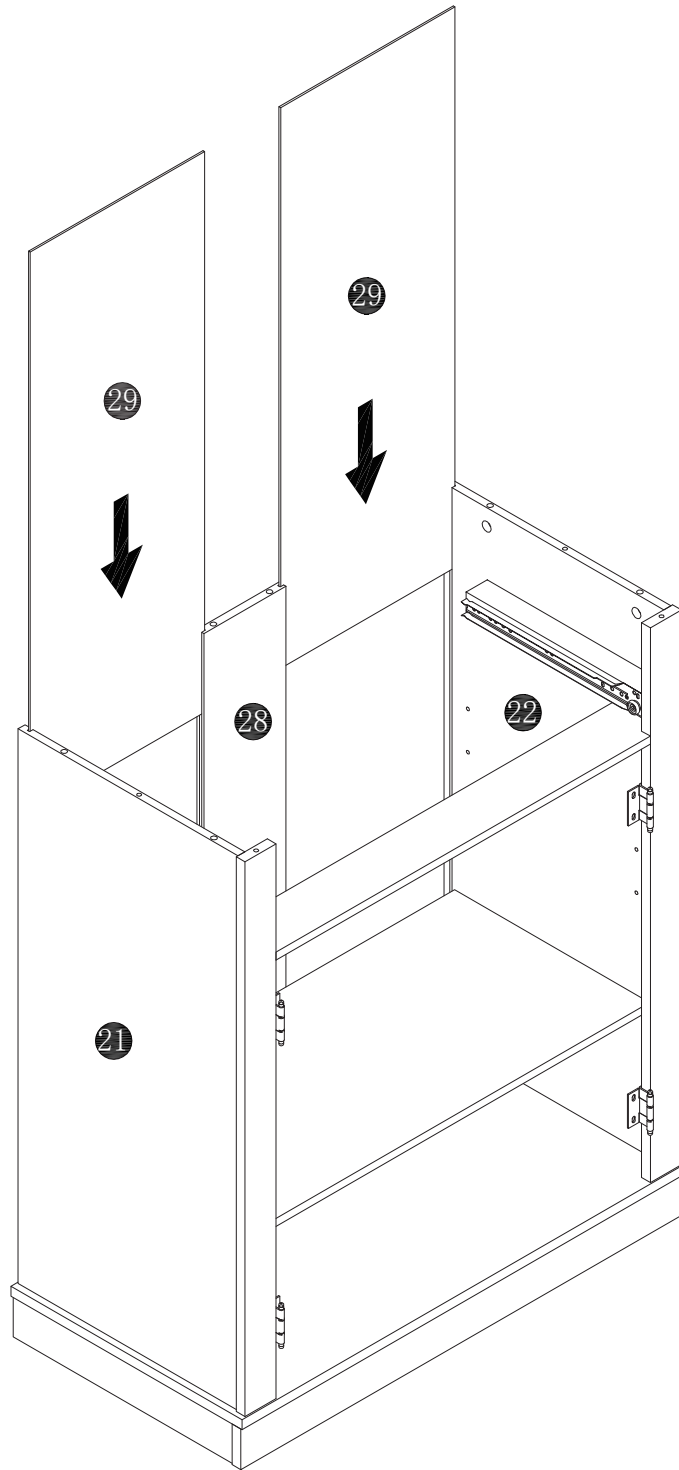

22

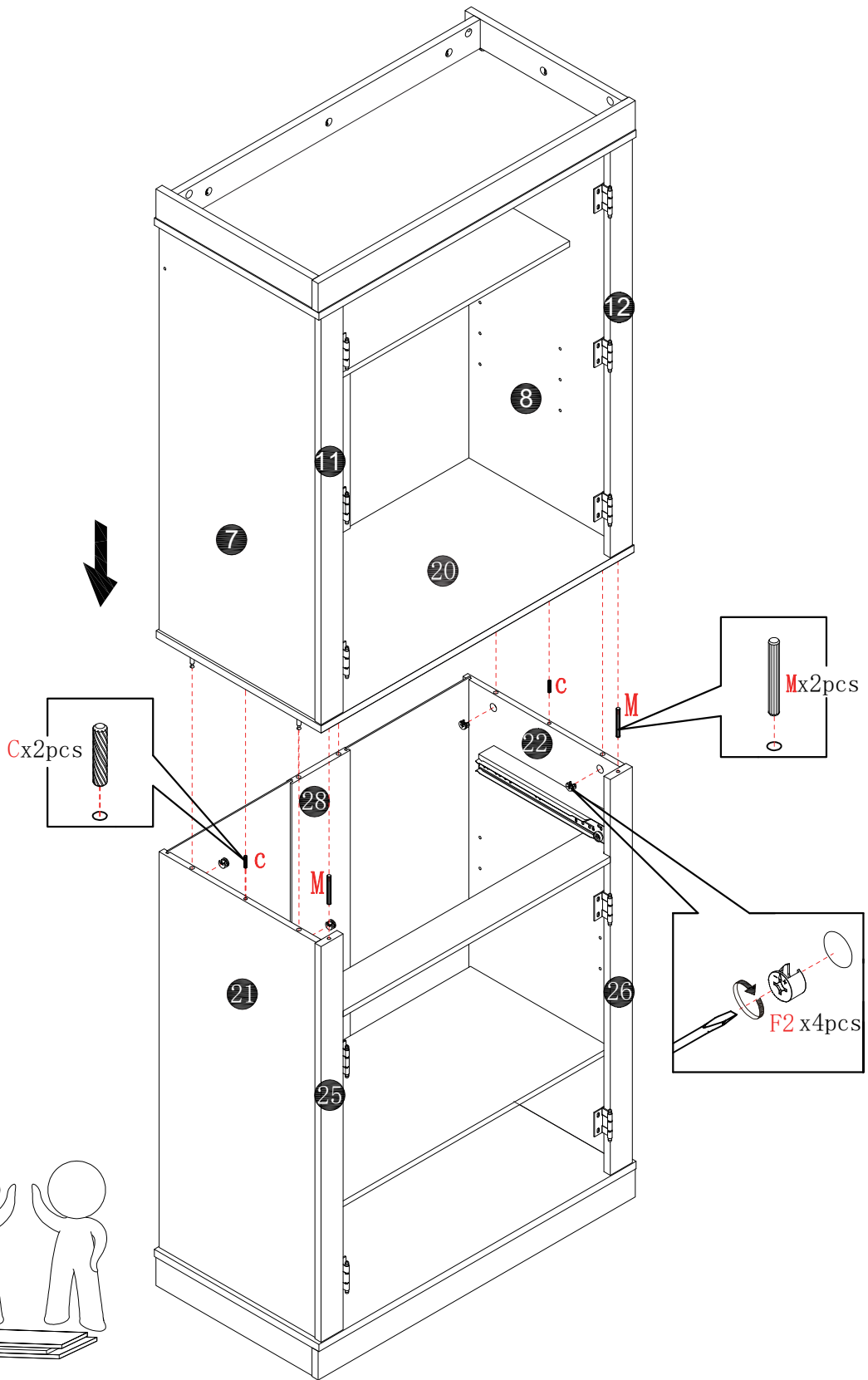
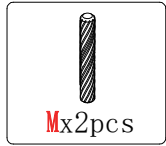
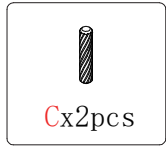
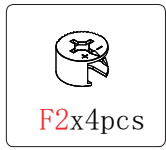

23



F2x2pcs



G1x16pcs



G2x16pcs

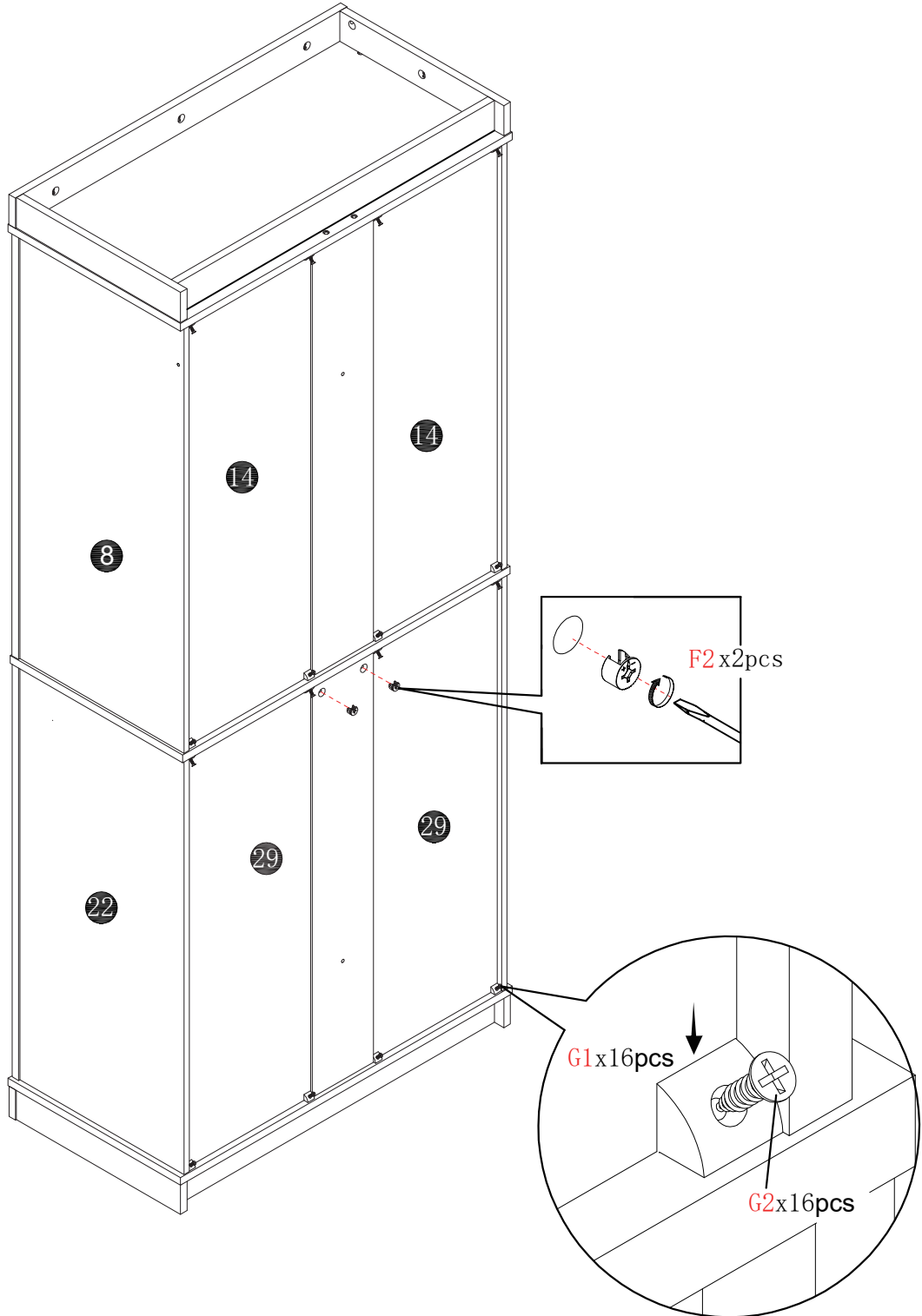

24

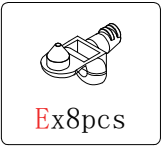

- 10 x1pc
- 23 x1pc

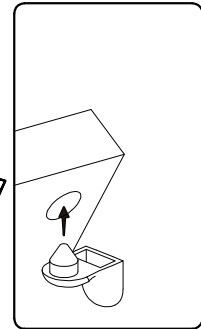
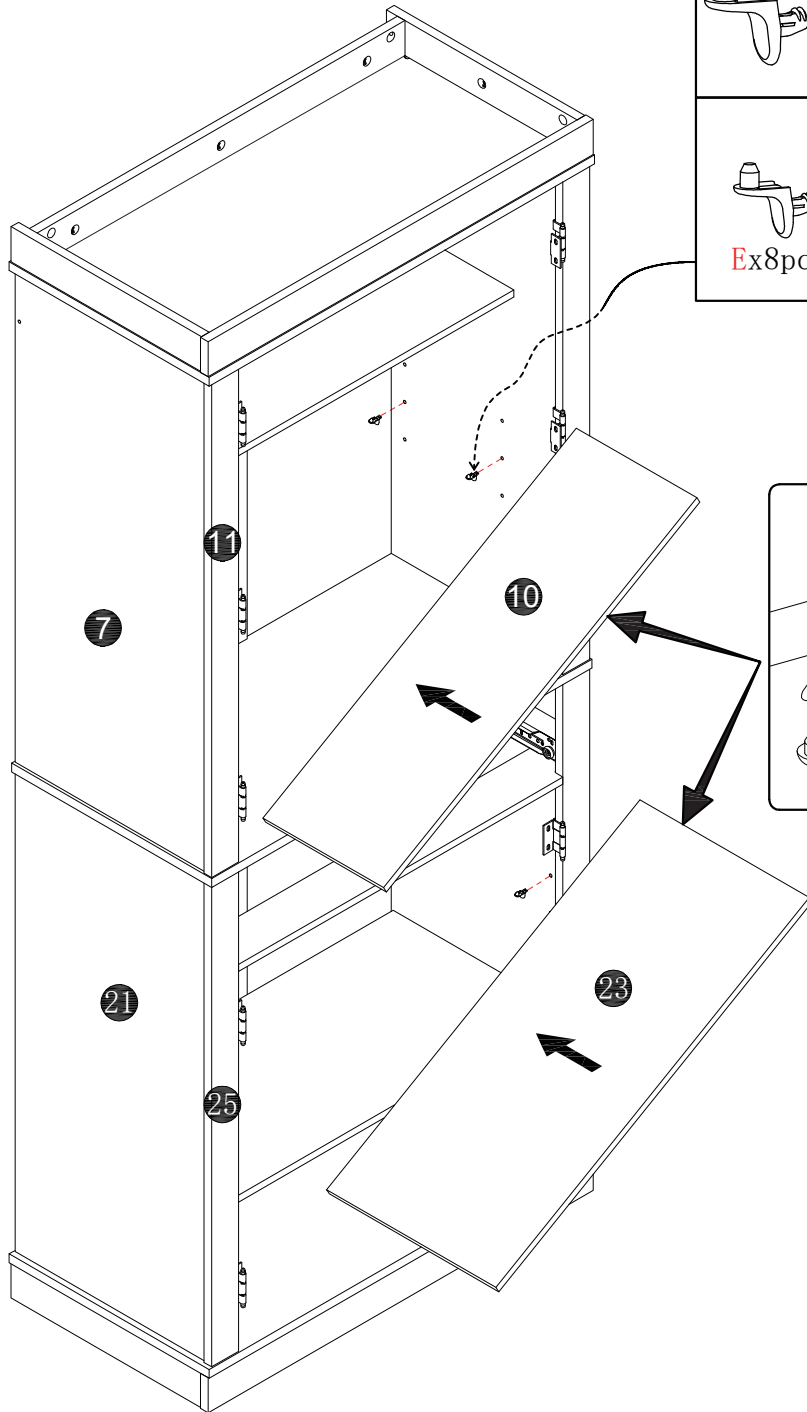
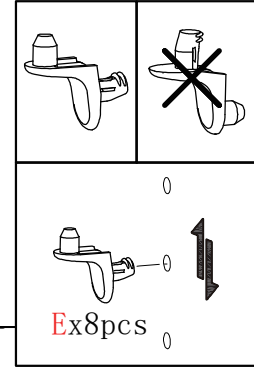

25

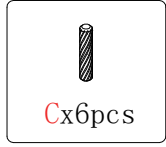
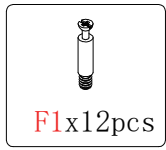

- 1 x6pcs
- 17 x2pcs
- 18 x2pcs
- 19 x6pcs

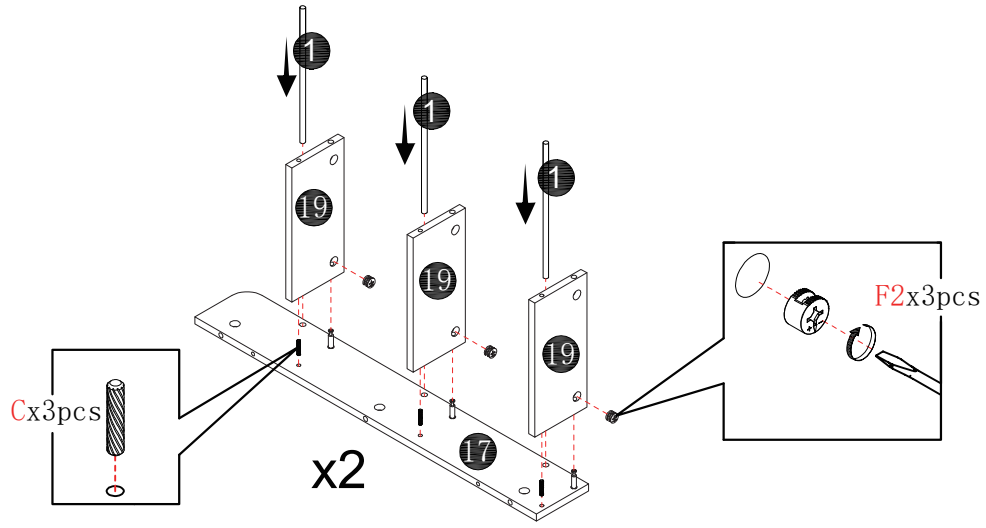
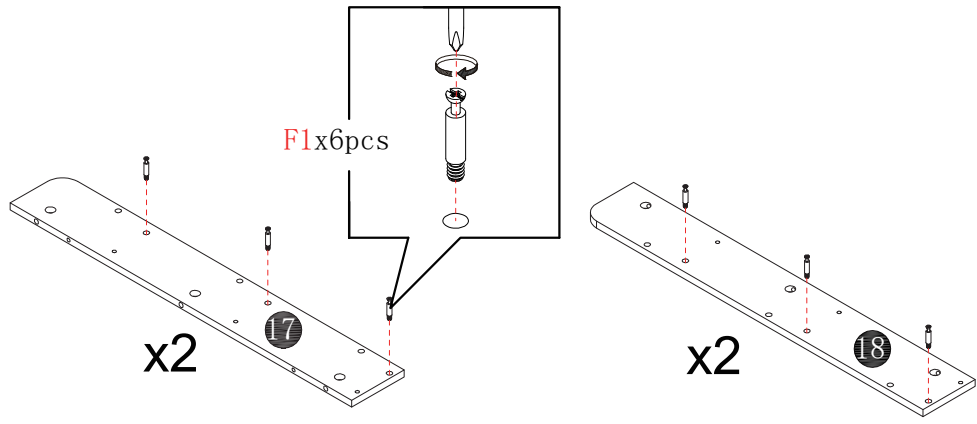

26

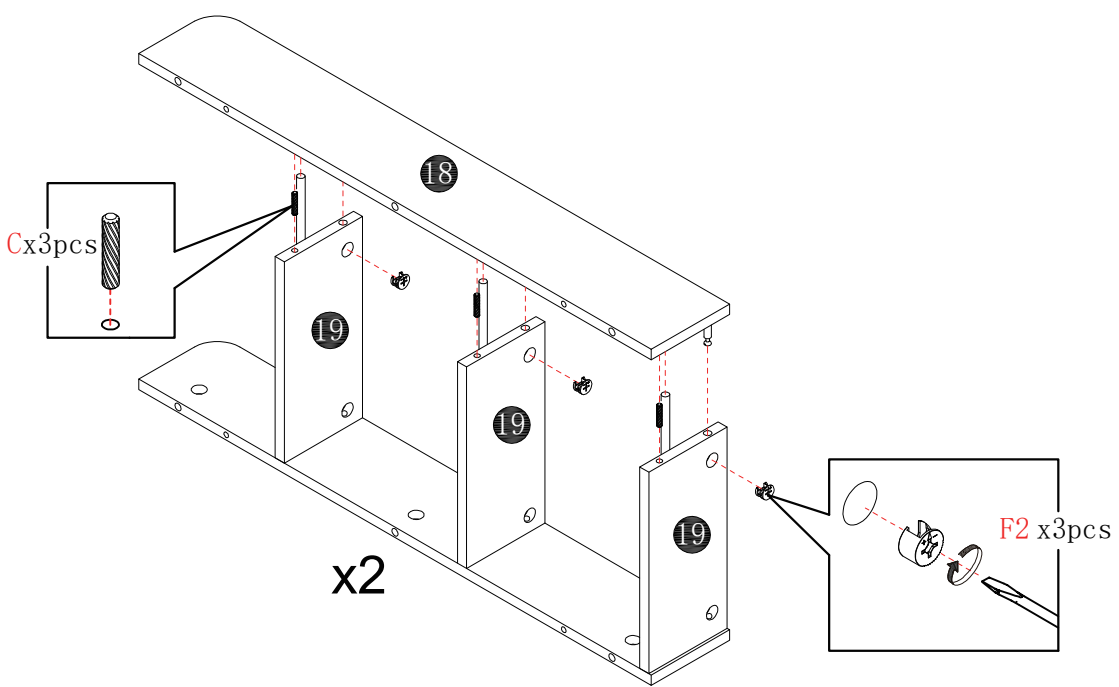
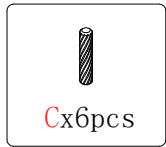

27

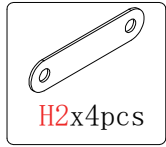
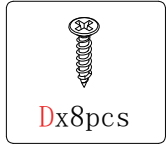
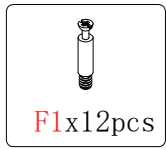

- 15 x 1pc
- 16 x 1pc
- 30 x 1pc
- 31 x 1pc

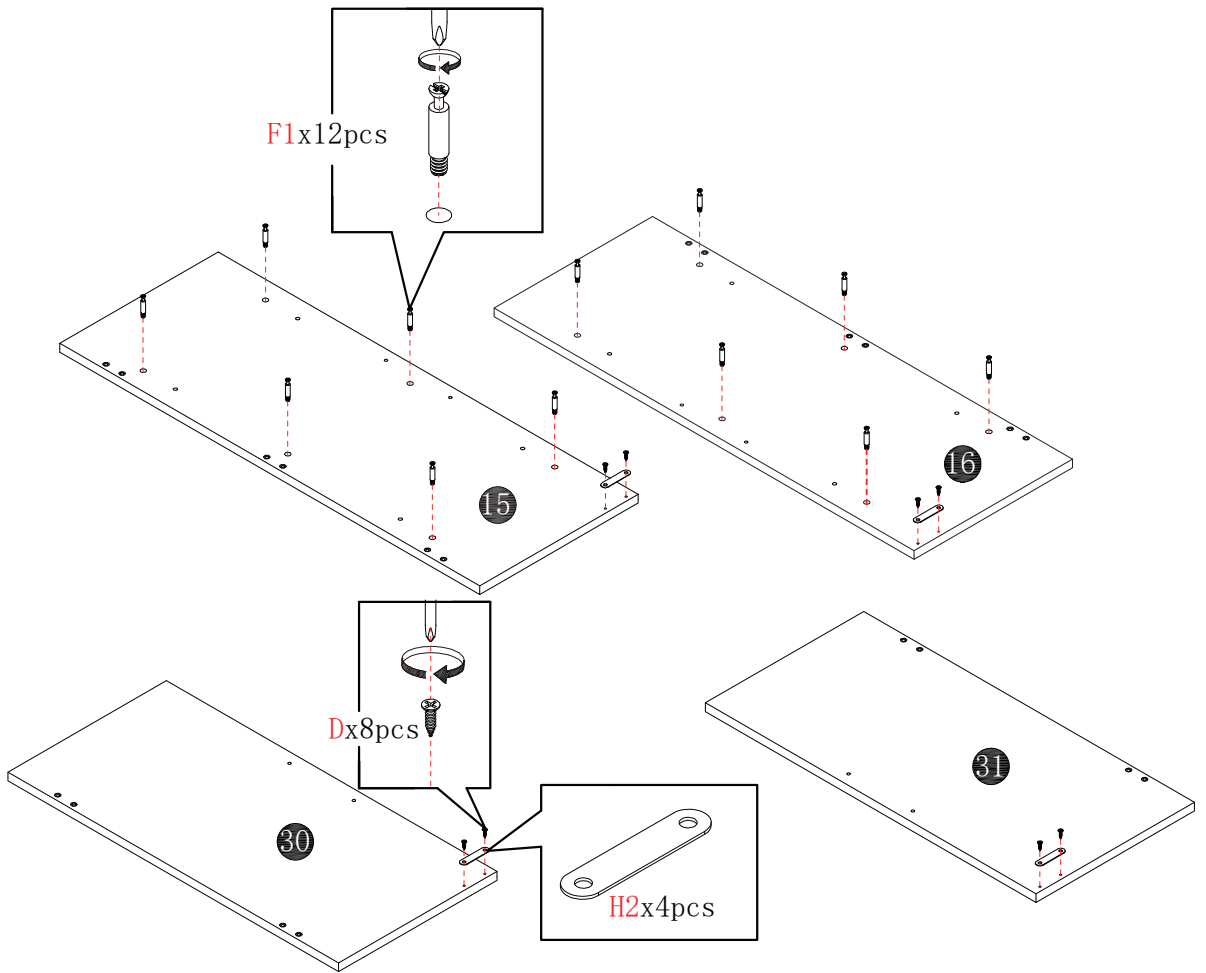

28

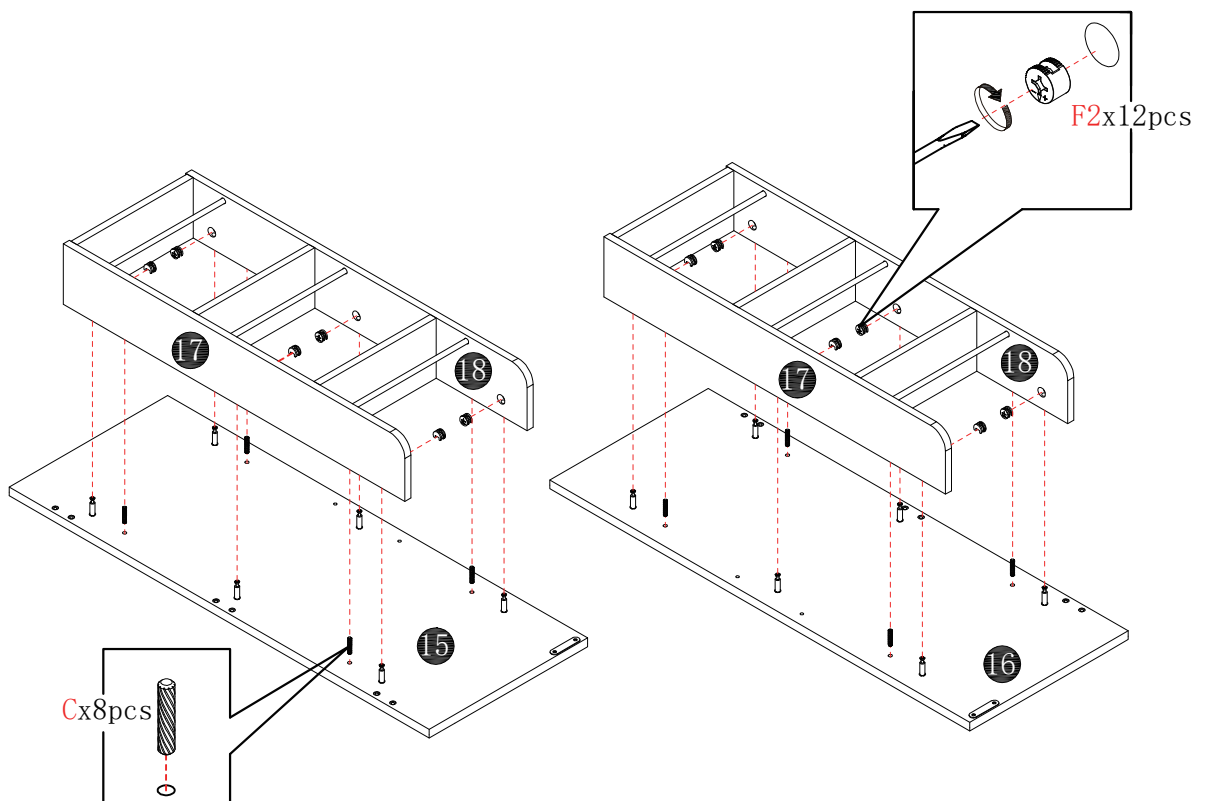
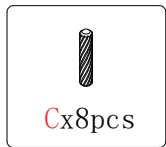

29

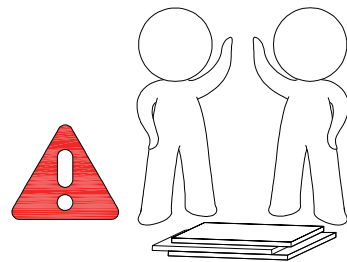
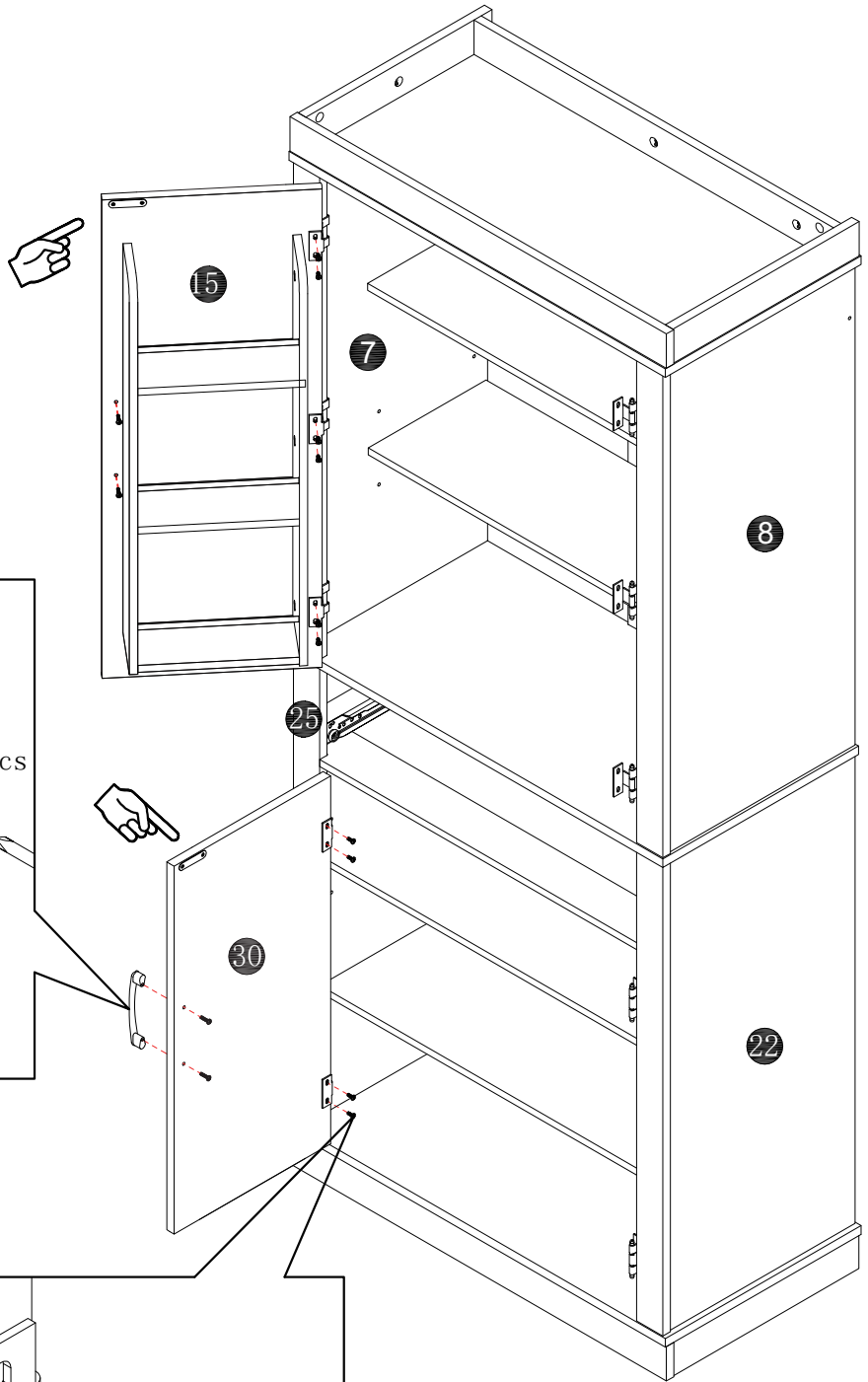
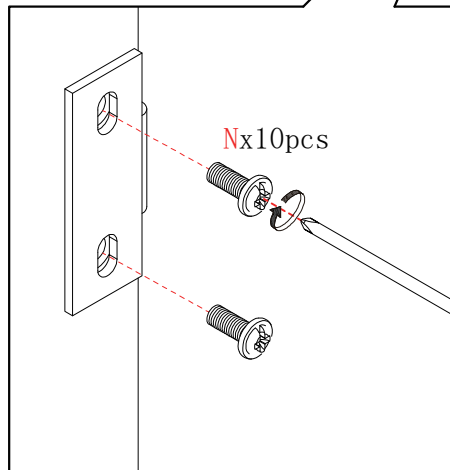
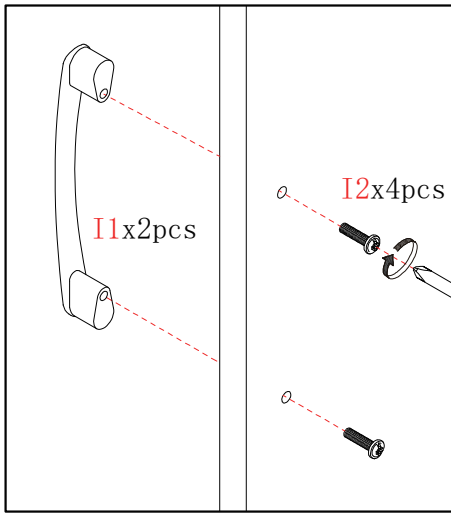
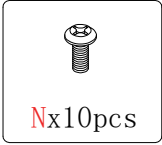
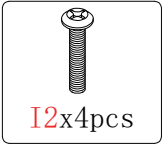
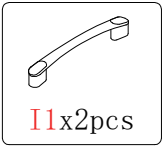

30

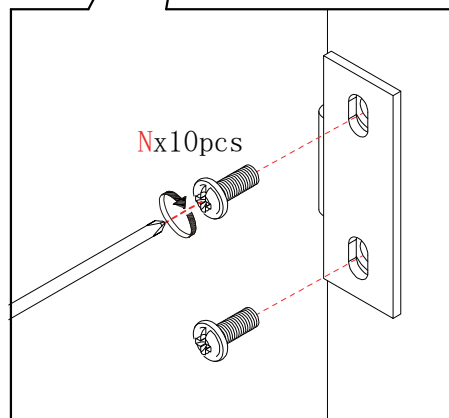
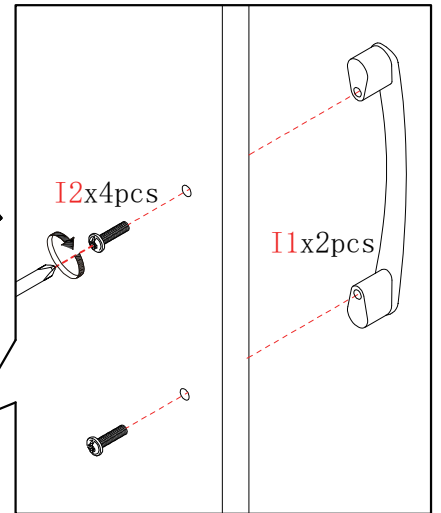
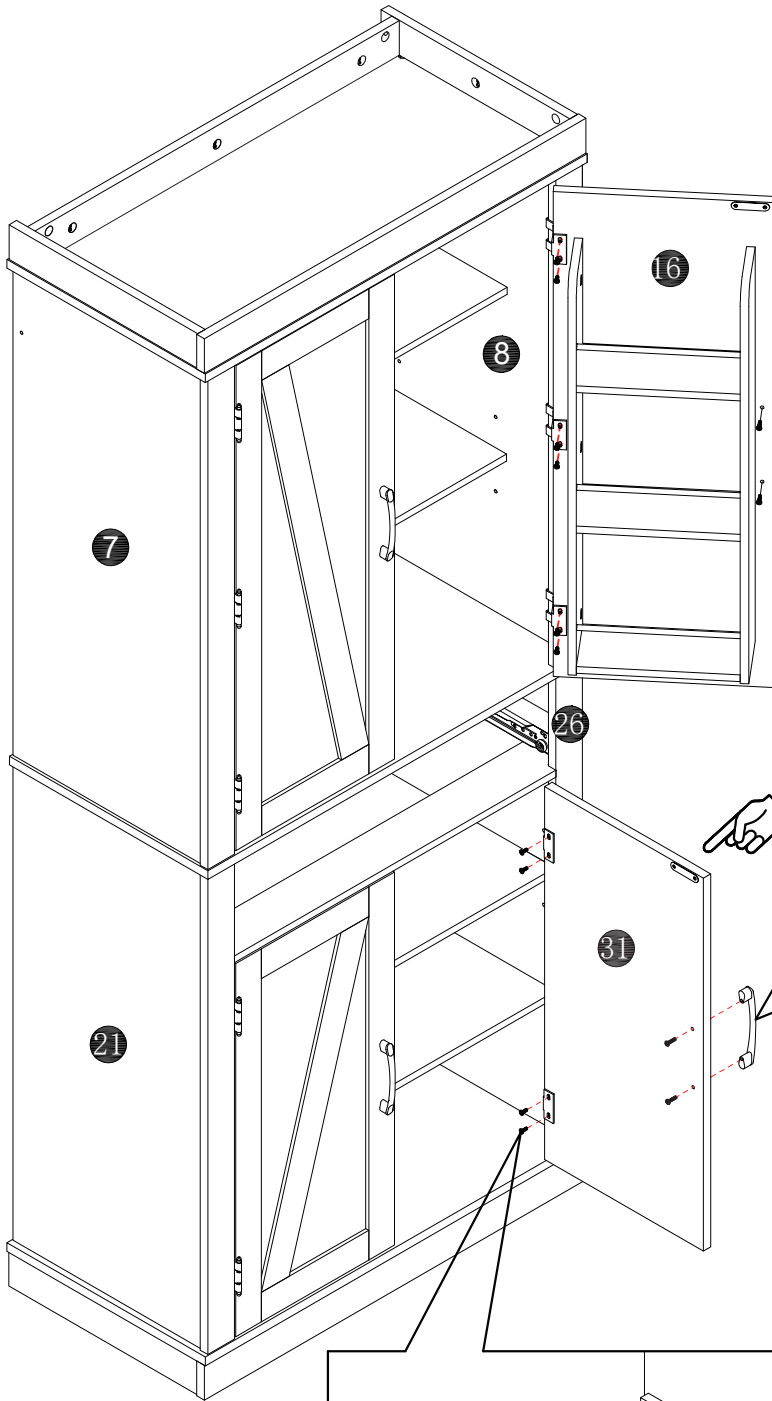
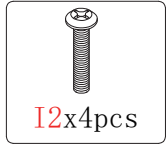
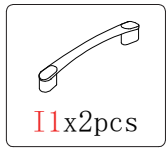

31

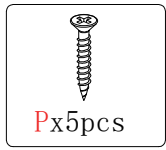

- 34 x1pc
- 35 x1pc
- 36 x1pc
- 38 x1pc

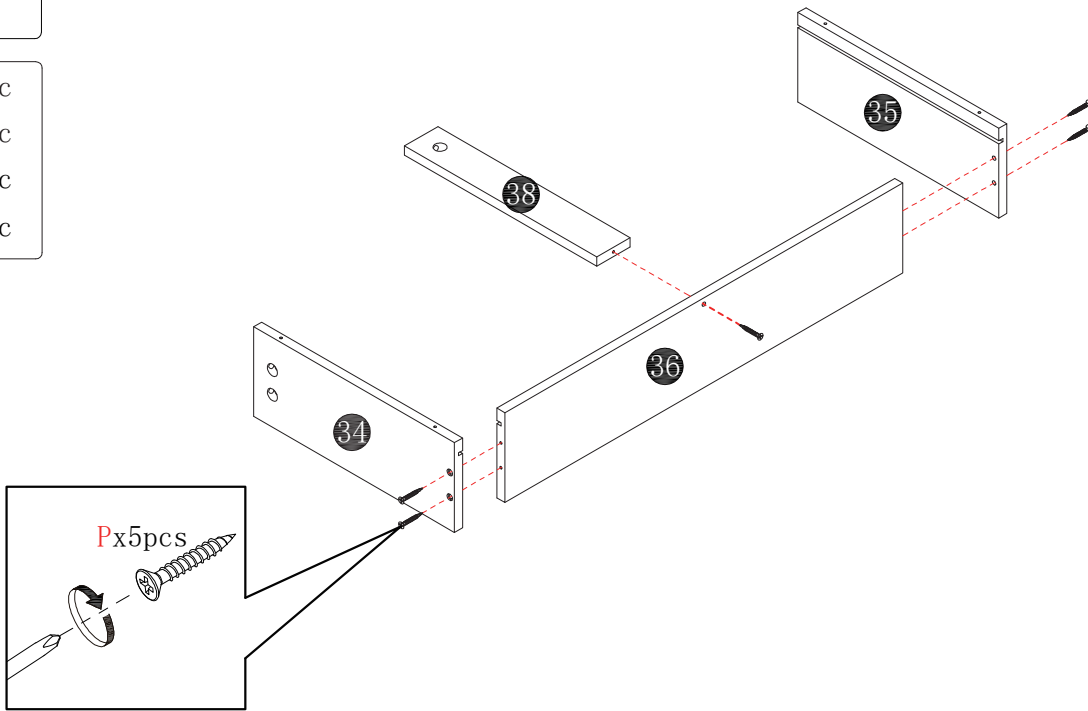

32

- 37 x1pc

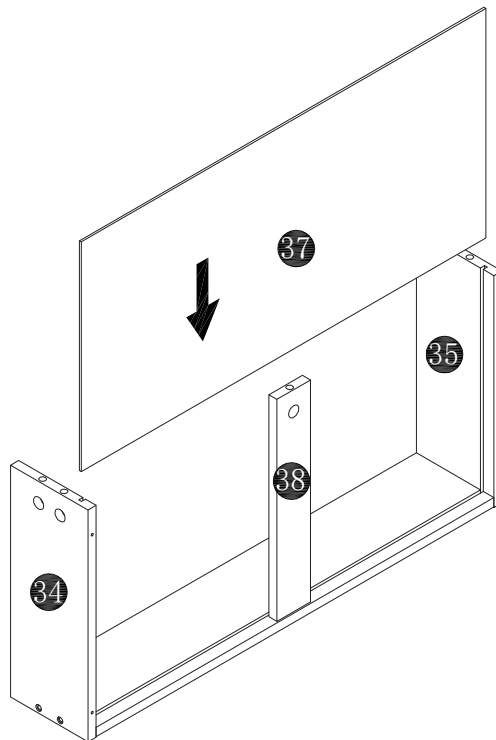

33

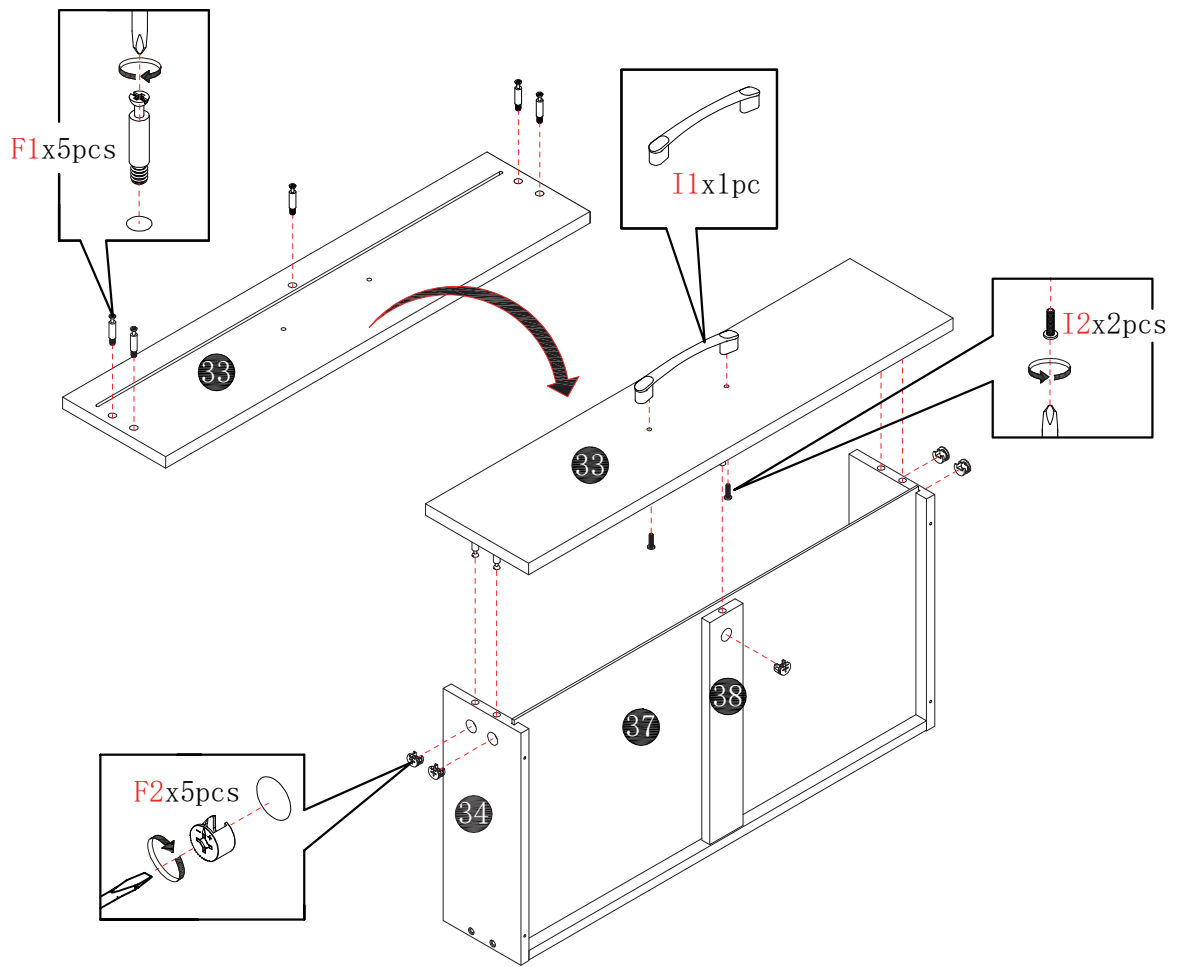
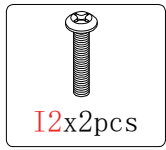
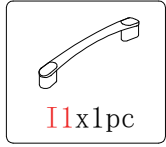
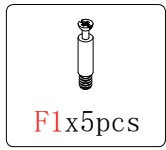

34

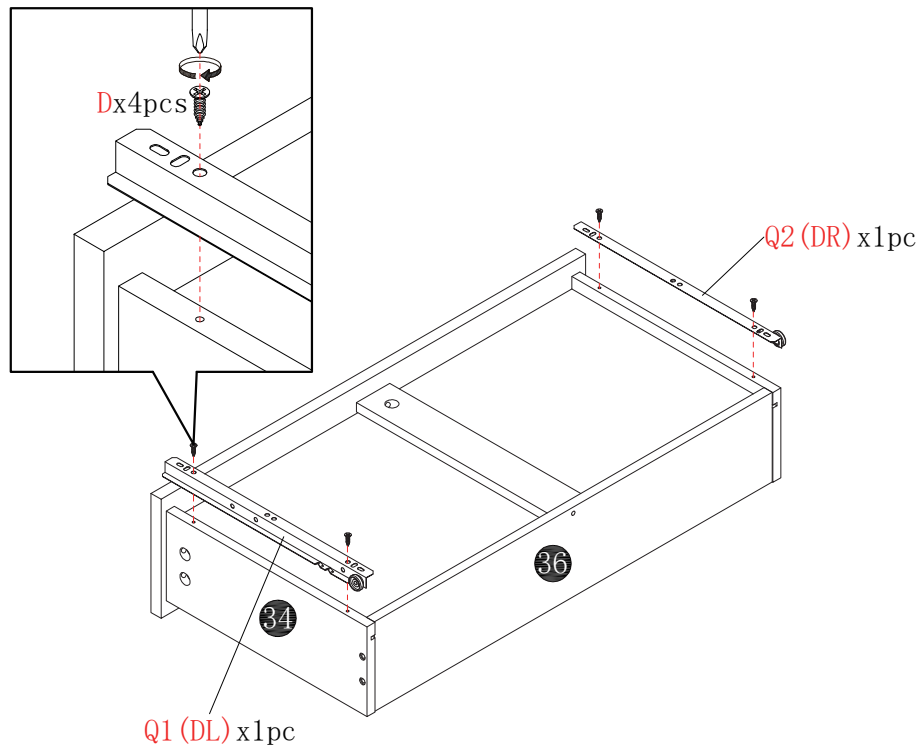
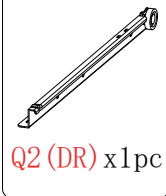
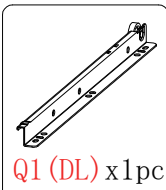
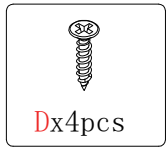

35

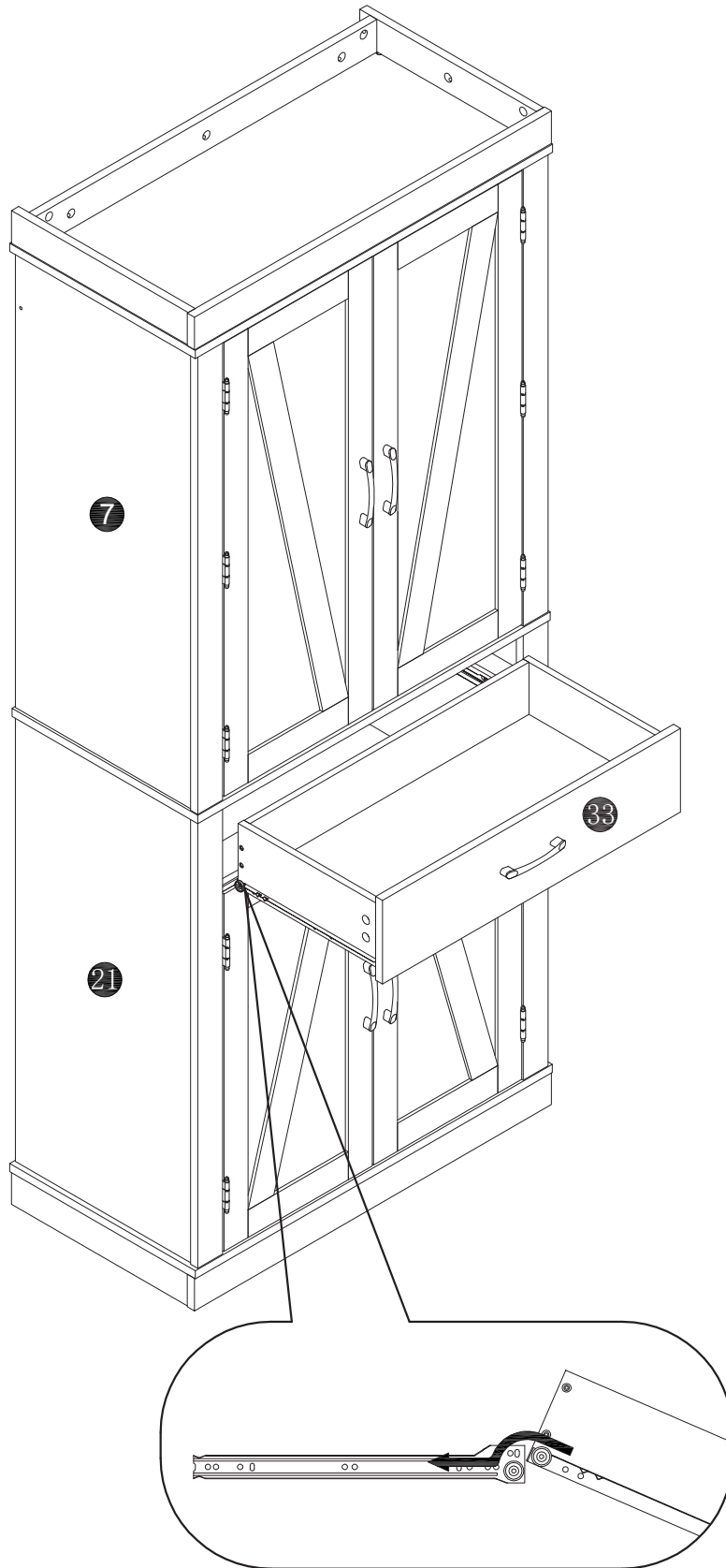

36

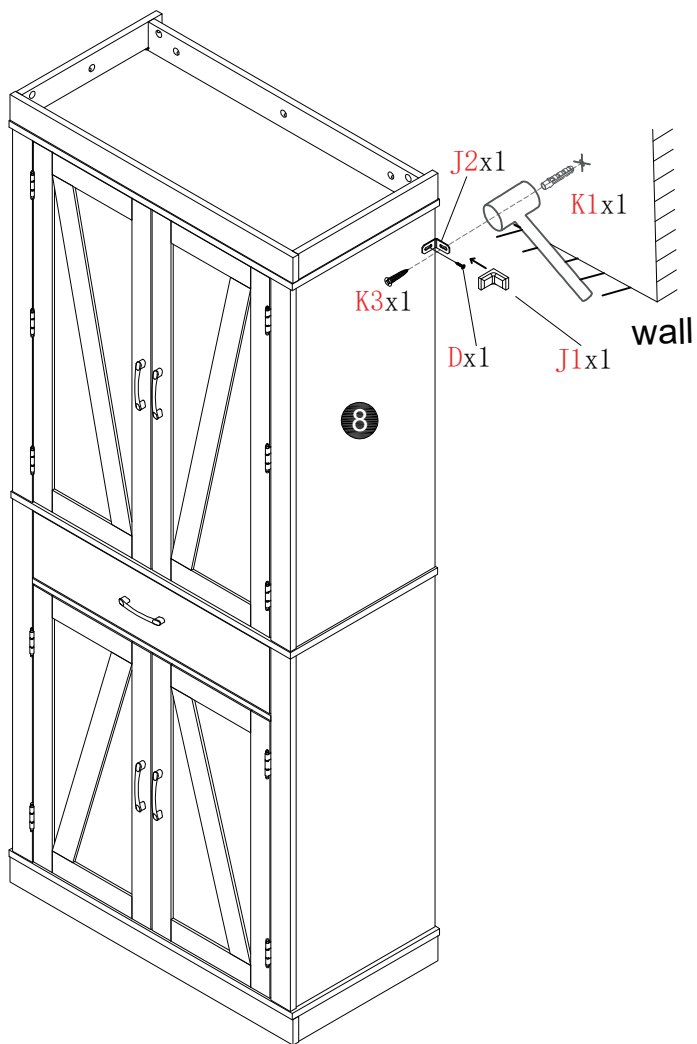
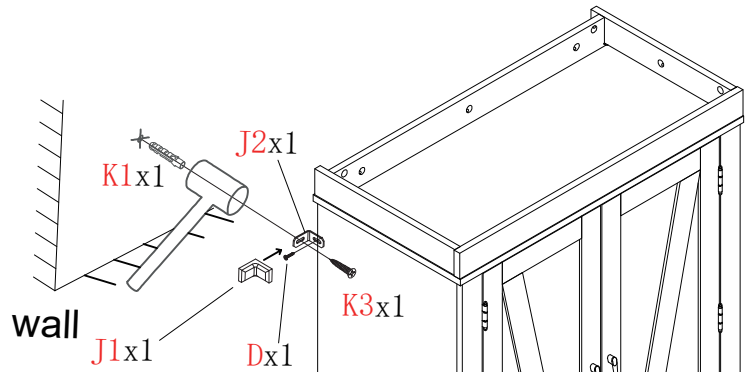
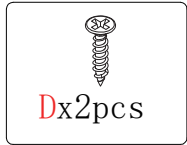
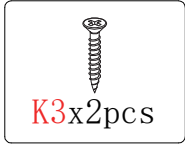
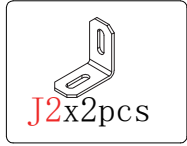
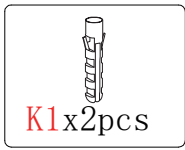
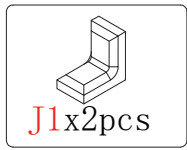

37

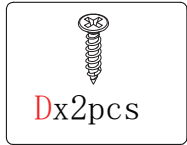
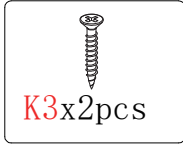
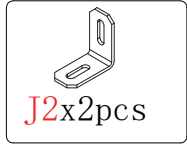
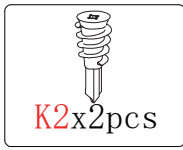
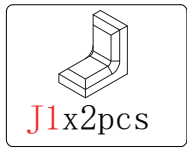

special wall stud

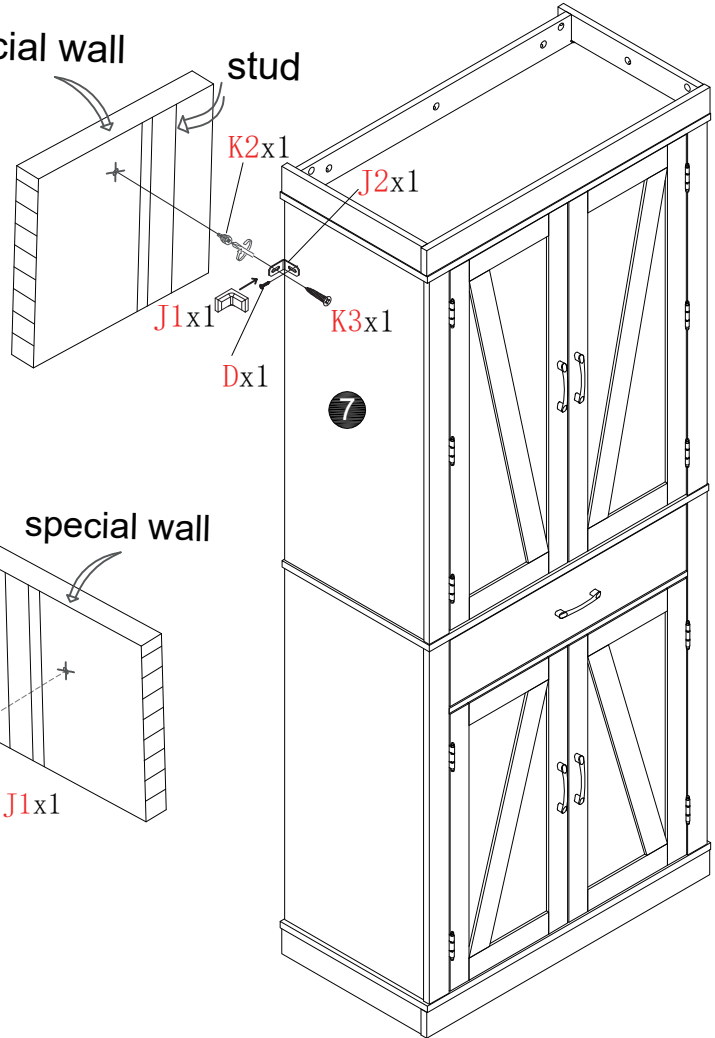

stud special wall

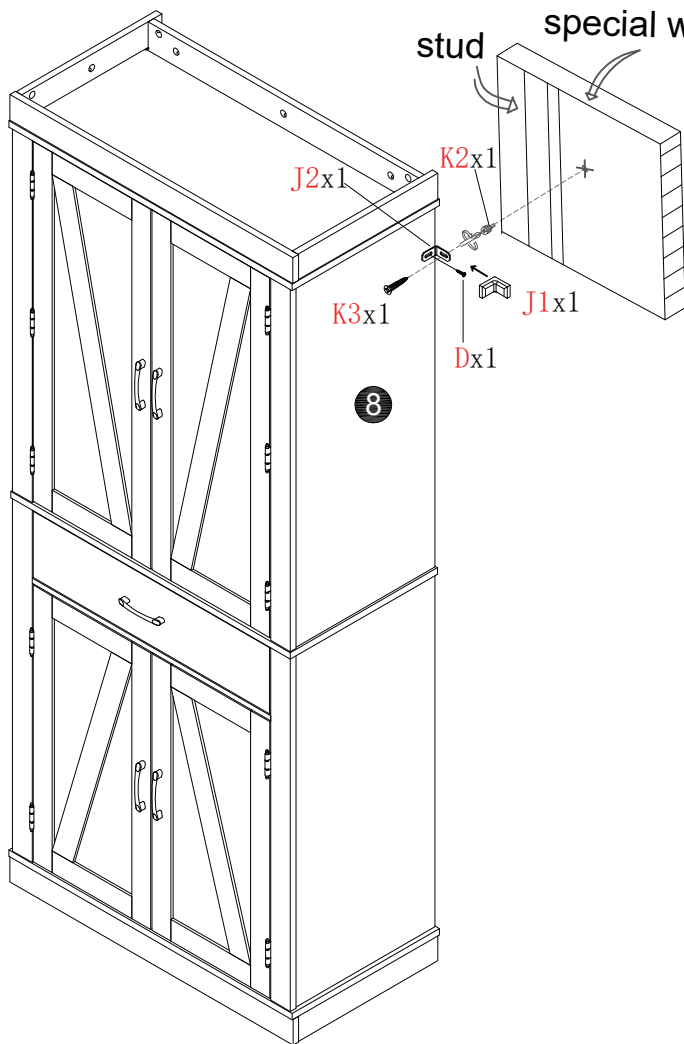

If you have any questions, please contact our customer care center, Our contact details are below:

US

 001-877-644-9366

 customerservice@aosom.com

Imported by Aosom LLC
7777 Center Ave. Suite 430
Huntington Beach, CA 92647-9998 USA
MADE IN CHINA

If you have any questions, please contact our customer care center, Our contact details are below:

CA

 416-792-6088

 customerservice@aosom.ca

Imported by Aosom Canada Inc.
7270 Woodbine Avenue, Unit 307, Markham,
Ontario Canada L3R 4B9
MADE IN CHINA

Si vous avez la moindre question, veuillez contacter notre centre d'assistance à la clientèle, Nos coordonnées sont les suivantes:

 416-792-6088

 customerservice@aosom.ca

Importé par Aosom Canada Inc.
7270 Woodbine Avenue, unité 307,
Markham, Ontario Canada L3R 4B9
FABRIQUÉ EN CHINE

If you have any questions, please contact our customer care center, Our contact details are below:

UK

 0044-800-240-4004

 enquiries@mhstar.co.uk

IMPORTER ADDRESS:
MH STAR UK Ltd
1 Northampton Cross Logistics Park
Northampton Cross Road
Northampton
NN4 9FH
MADE IN CHINA

Si vous avez la moindre question, veuillez contacter notre centre d'assistance à la clientèle, Nos coordonnées sont les suivantes:

 0033-1-84166106

 aosom@mhfrance.fr

Importé par/Fabricant/REP:
MH FRANCE
2 Rue Maurice Hartmann
92130 Issy Les Moulineaux
France
FABRIQUÉ EN CHINE

Si tiene alguna pregunta, comuníquese con nuestro Centro de Atención al Cliente, Nuestros datos de contacto son los siguientes:

ES

 0034-931294512

 atencioncliente@aosom.es

IMPORTADOR/Fabricante/REP:
SPANISH AOSOM, S.L.
C/ROC GROS,Nº15.08550, ELS HOSTALET DE
BALENYÀ, SPAIN.
B66295775
HECHO EN CHINA

Se tiver alguma dúvida, por favor contacte o nosso Centro de Atendimento ao Cliente, Os nossos dados de contacto são os seguintes:

 0034-931294512

 info@aosom.pt.

IMPORTADOR/Fabricante/REP:
SPANISH AOSOM, S.L.
C.ROC GROS N.15, 08550. ELS HOSTALET DE
BALENYÀ
FEITO NA CHINA

In caso di dubbio, si prega di contattare il nostro centro assistenza clienti, I nostri dettagli di contatto sono di seguito:

IT

 0039-0249471447

 clienti@aosom.it

IMPORTATO DA/Produttore/REP:
AOSOM Italy srl
Centro Direzionale Milanofiori
Strada 1 Palazzo F1
20057 Assago (MI)
P.I.: 08567220960
FATTO IN CINA

Wenn Sie Fragen haben, wenden Sie sich bitte an unser Kundendienstzentrum, Unsere Kontaktdaten stehen unten:

DE

 0049-0(40)-87408465

 service@aosom.de

ADRESSE DES IMPORTEURE/Hersteller/REP:
MH Handel GmbH
Wendenstraße 309
D-20537 Hamburg
Germany
IN CHINA HERGESTELLT

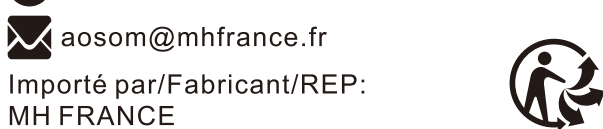

FR

**DONNEZ
OU
RECYCLEZ**



OU



OU



ASSOCIATION

LIVRAISON

DÉCHÈTERIE

Adresses sur quefairedemesdechets.fr

FR