

EN_IMPORTANT, RETAIN FOR FUTURE REFERENCE: READ CAREFULLY.

FR_IMPORTANT: A LIRE ATTENTIVEMENT ET A CONSERVER POUR VOUS Y REFRERER ULTERIEUREMENT

ES_IMPORTANTE, LEA DETENIDAMENTE Y GUARDE PARA FUTURAS REFERENCIAS.

PT_IMPORTANTE, GARDE PARA FUTURA REFERÊNCIA, LEIA ATENTAMENTE.

DE_WICHTIG! SORFGFÄLTIG LESEN UND FÜR SPÄTERES NACHSCHLAGEN AUFBEWAHREN.

IT_IMPORTANTE, LEGGERE E CONSERVARE QUESTO MANUALE D'ISTRUZIONE PER UN USO FUTURO.

RO_IMPORTANT, DE PĂSTRAT PENTRU REFERINȚE VIITOARE: CITIȚI CU ATENȚIE.

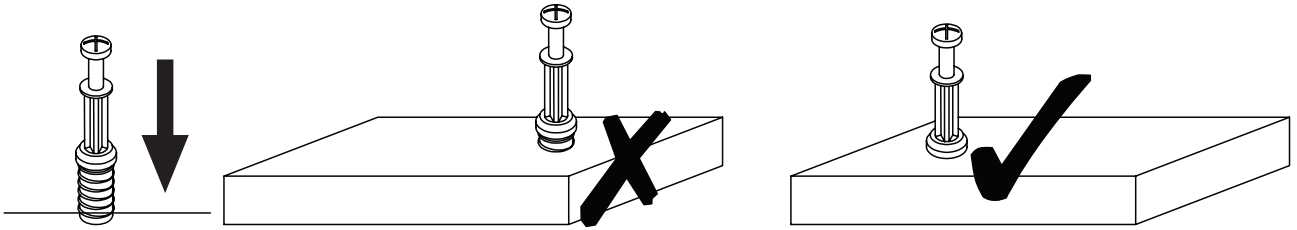

EN_ QUICKFIT: Tighten quickfit until shoulder is flush with panel. Do not overtighten or undertighten.

FR_ RACCORD RAPIDE: Faites serrer le raccord rapide jusqu'à ce que l'épaulement soit parfaitement encastré dans le panneau. Il ne faut ni trop serrer ni insuffisamment serrer.

ES_ QUICKFIT: Apriete quickfit hasta que el hombro se descargue con el panel. NO lo sobreapriete ni lo apriete poco.

PT_ AJUSTE RÁPIDO: Aperte o ajuste rápido até estar nivelada com o painel. Não apertar demasiado ou excessivamente.

DE_ QUICKFIT: Ziehen Sie den Quickfit fest, bis die Schulter mit der Platte bündig ist. Bitte nicht zu fest oder zu schwach anziehen.

IT_ MONTAGGIO RAPIDO: Stringere il montaggio rapido fino a quando la spalla è a filo con il pannello, non stringere troppo o troppo poco.

RO_ QUICKFIT: Strângeți quickfit până când umărul este la același nivel cu panoul. Nu strângeți prea tare și nici prea slab.

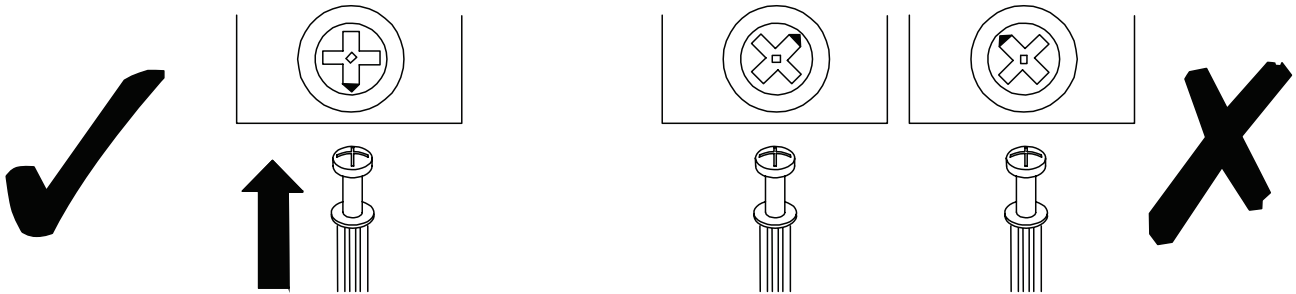

EN_ CAM LOCK: When fitting cam lock, ensure starting position is correct before you insert connecting quickfit.

FR_ SERRURE BATTEUSE: Avant d'insérer la serrure batteuse, veillez à la bonne orientation avant d'insérer le raccord rapide.

ES_ CIERRE DE LA CÁMARA: Cuando instale el cierre de la cámara, asegúrese de que la posición de inicio es correcta antes de que inserte el quickfit conector.

PT_ BLOQUEIO: Ao instalar o bloqueio, assegurar-se de que a posição inicial está correcta antes de inserir o encaixe de ligação rápida.

DE_ CAM-LOCK: Achten Sie bei der Montage des Cam-Locks auf die richtige Ausgangsposition, bevor Sie den Quickfit einsetzen.

IT_ BLOCCAGGIO A CAMMA: Quando si monta il bloccaggio a camma, assicurarsi che la posizione iniziale sia corretta prima di inserire il montaggio rapido di collegamento.

RO_ BLOCARE CU CAME: Când montați blocarea cu came, asigurați-vă că poziția inițială este corectă înainte de a introduce racordul rapid.

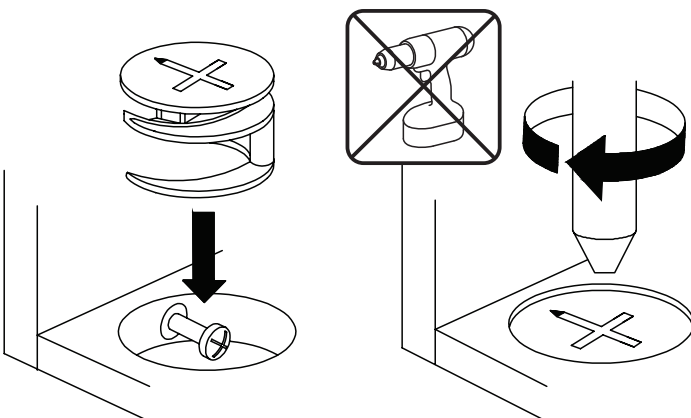

EN_ Turn cam lock clockwise to tighten.

FR_ Faites tourner la serrure batteuse dans le sens des aiguilles d'une montre pour la resserrer.

ES_ Gire el cierre de la cámara en sentido horario para apretarlo.

PT_ Rodar o bloqueio no sentido dos ponteiros do relógio para o apertar.

DE_ Drehen Sie den Cam-Lock im Uhrzeigersinn, um ihn festzuziehen.

IT_ Ruotare il bloccaggio a camma in senso orario per stringere.

RO_ Rotiți blocarea cu came în sensul acelor de ceasornic pentru a strânge.

1 x 1

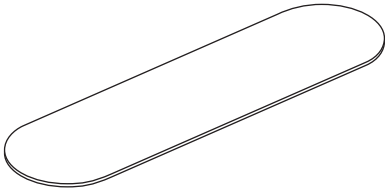

2 x 1

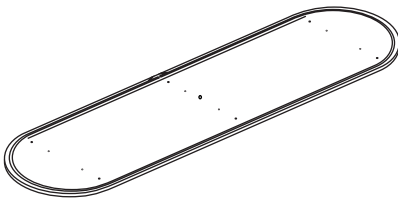

3 x 1

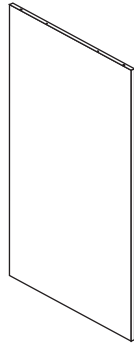

4 x 1

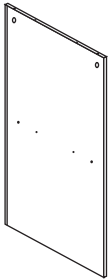

5 x 1

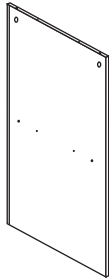

6 x 4

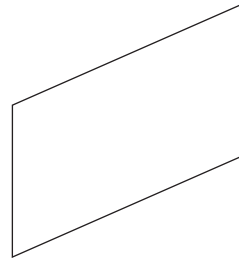

7 x 1

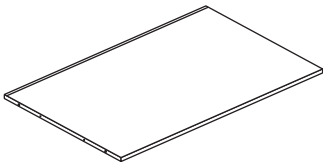

8 x 4



9 x 1





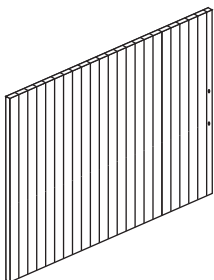

10 x 2

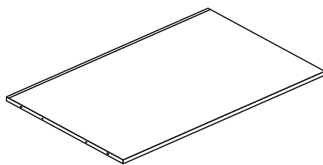

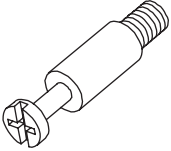
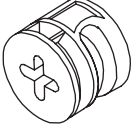
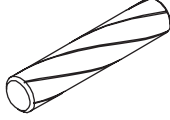
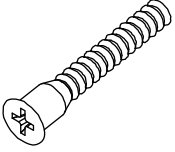
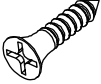
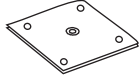
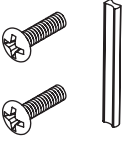
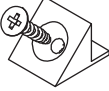
11 x 1

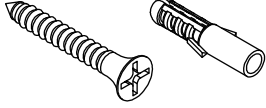
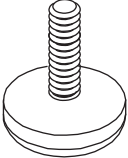

 <p>A x14 M6x35 +1(spare)</p>	 <p>B x14 M15x9.5 +1(spare)</p>	 <p>C x20 M6x30 +2(spare)</p>
 <p>D x7 M5x40 +1(spare)</p>	 <p>E x20 M3.5x12 +2(spare)</p>	 <p>F x5</p>
 <p>G x2 M4x10</p>	 <p>H x16 M3x16 +1(spare)</p>	 <p>I x2 M3.5x12</p>
 <p>J x2 M6x30</p>	 <p>K x1</p>	 <p>L x4 M5x40</p>

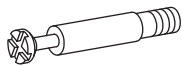

A x 14

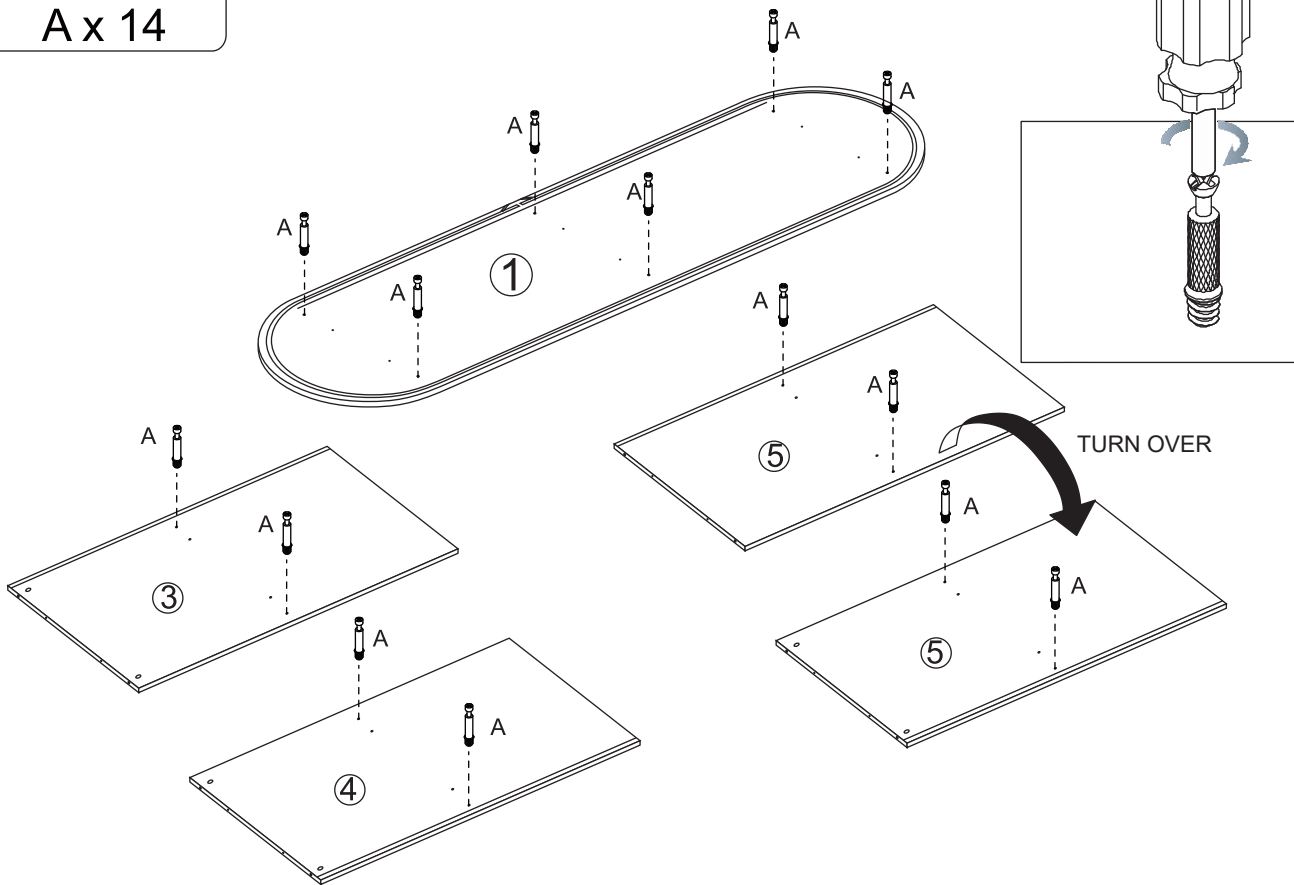

B x 8

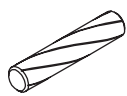

C x 8

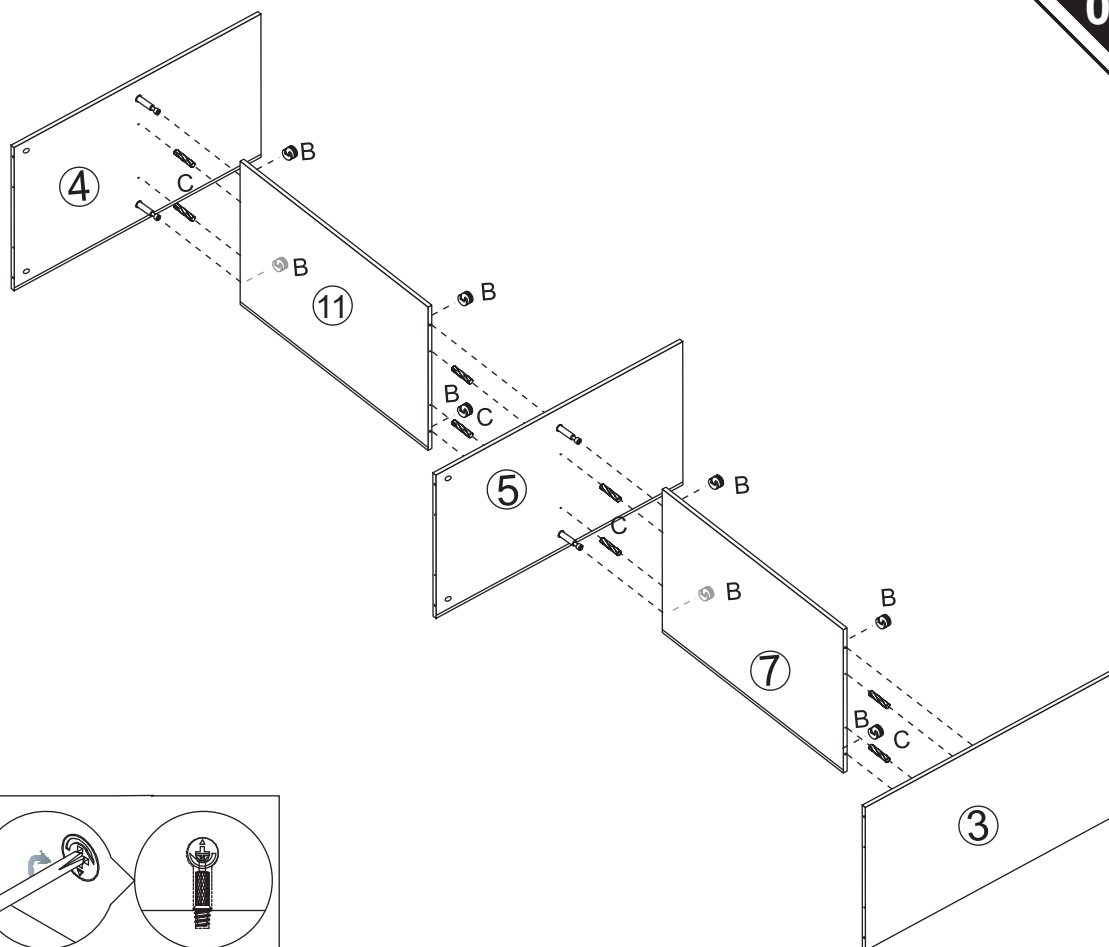

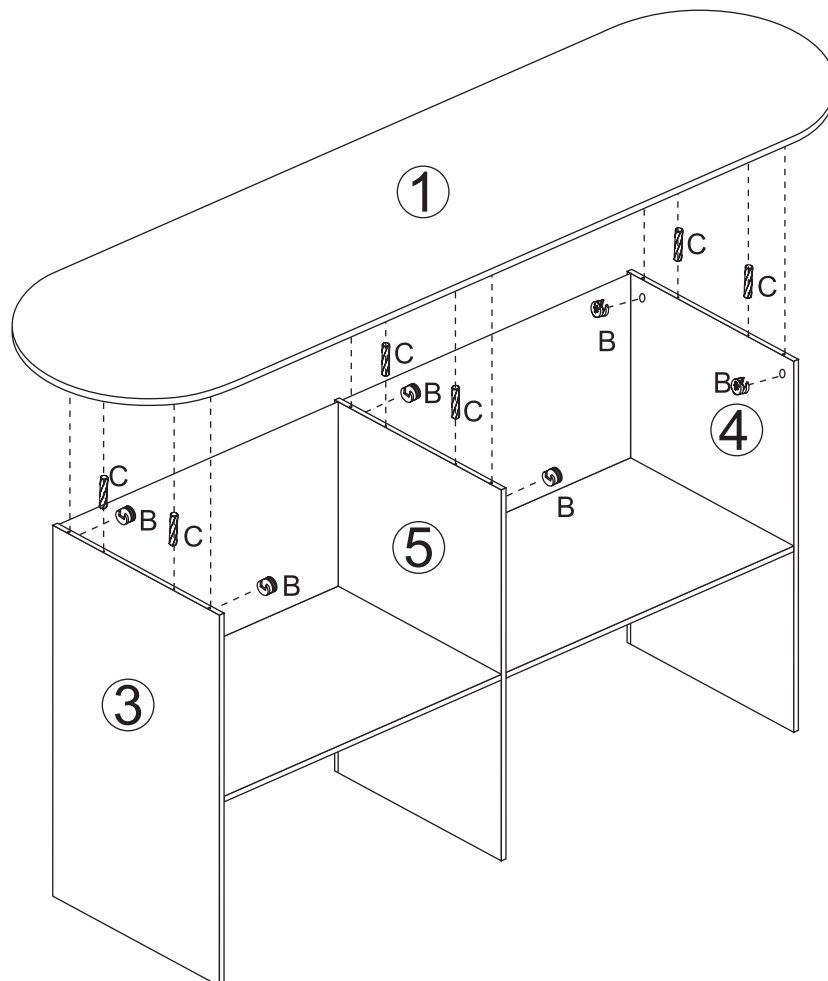
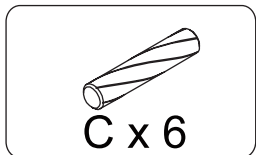
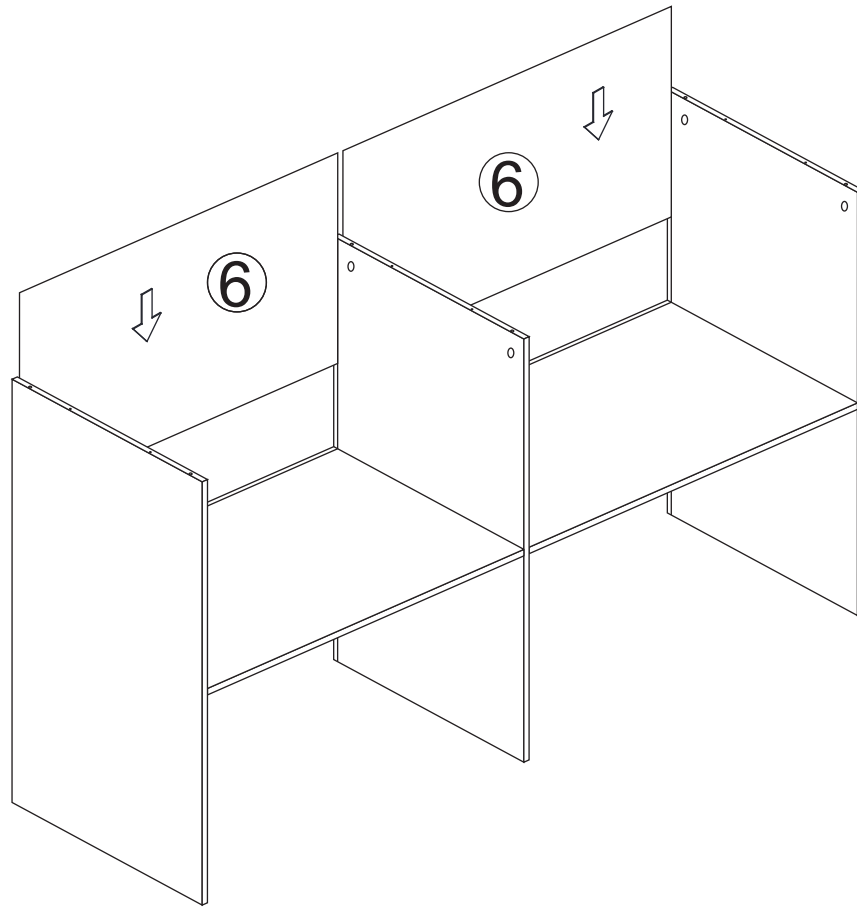

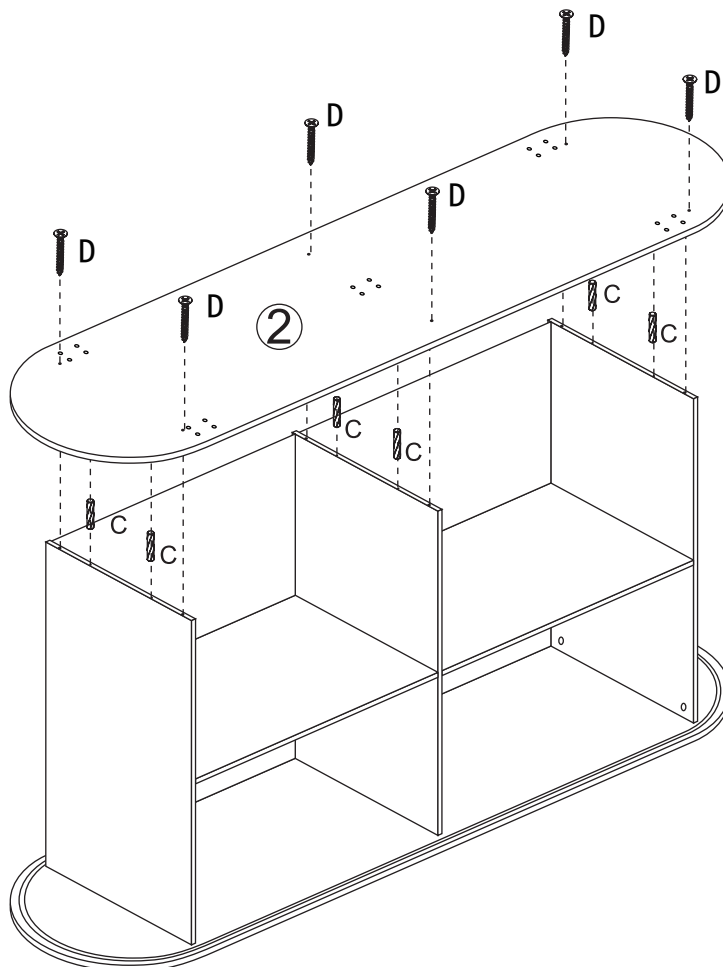
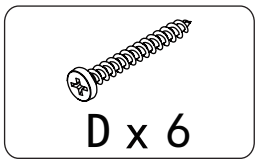
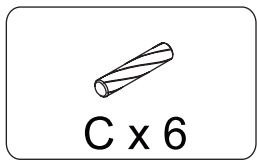
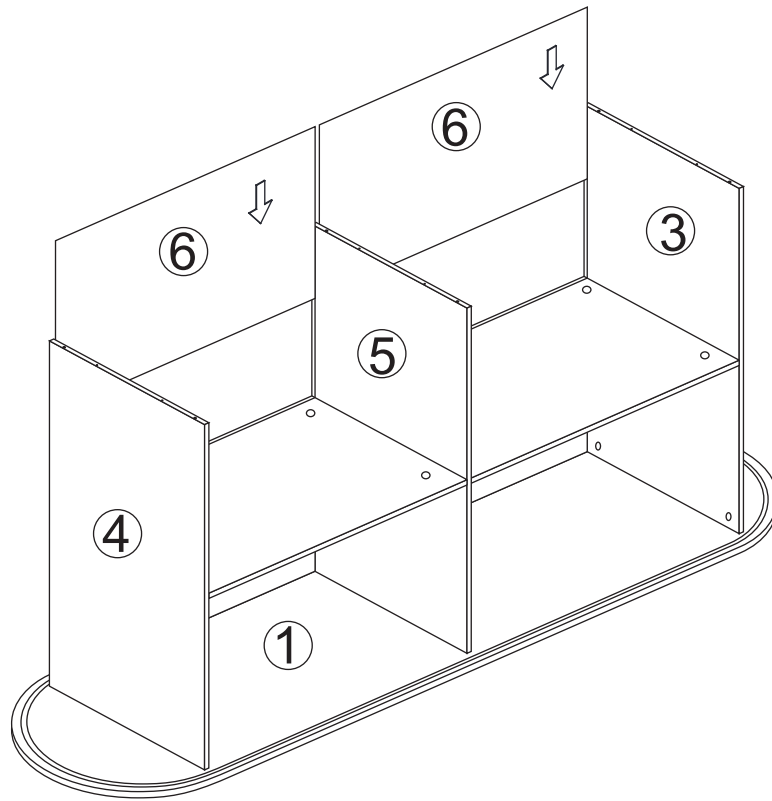

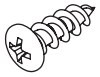

E x 20



F x 5

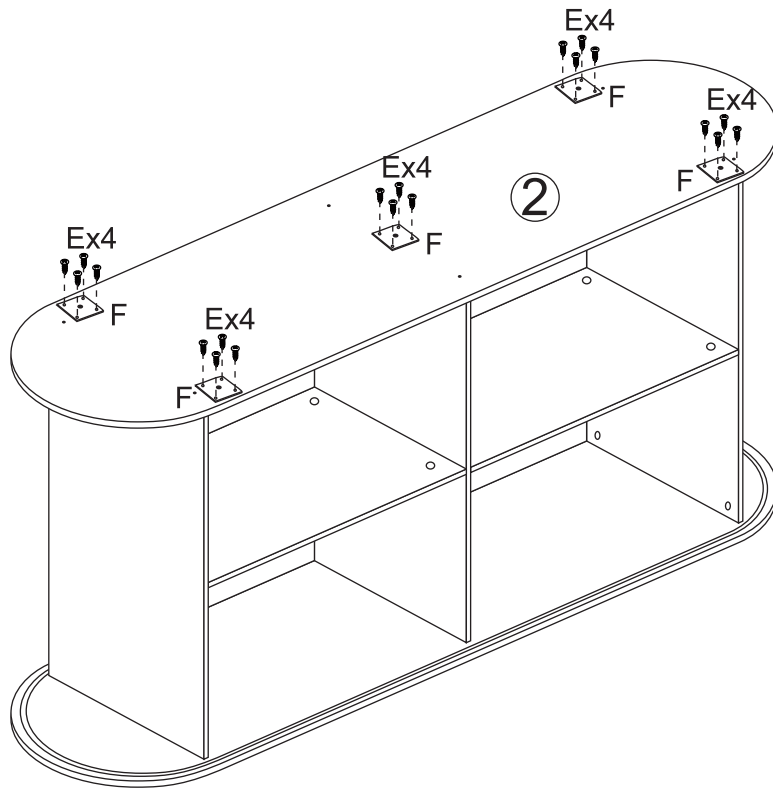

L x 4



K x 1

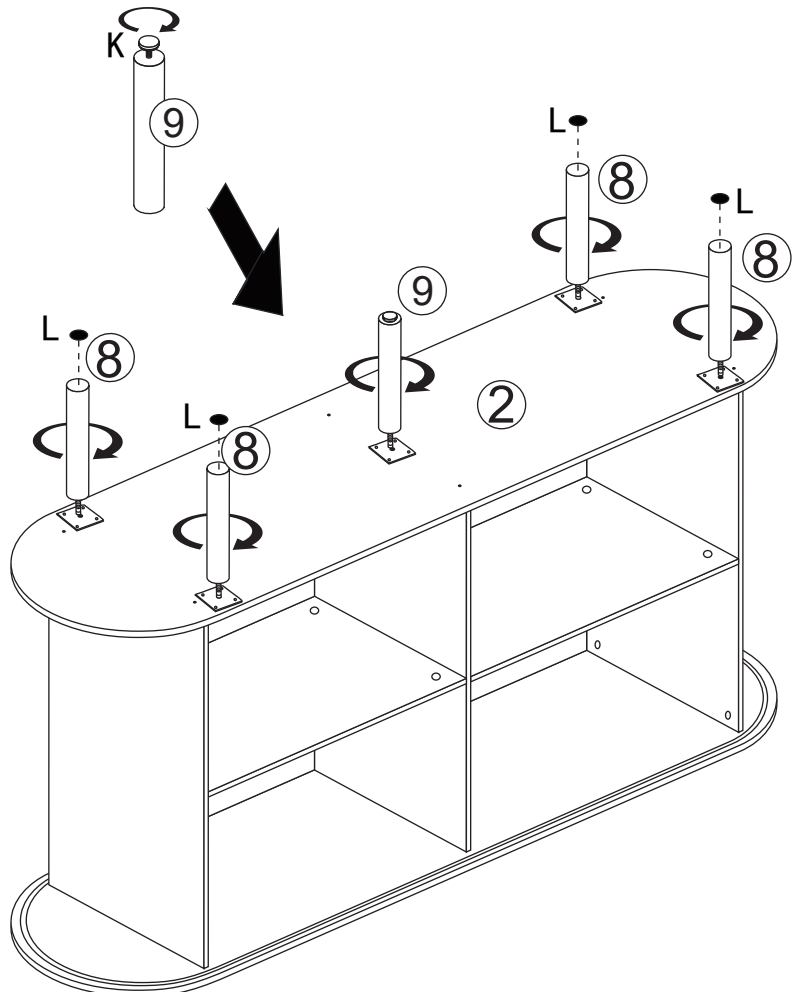

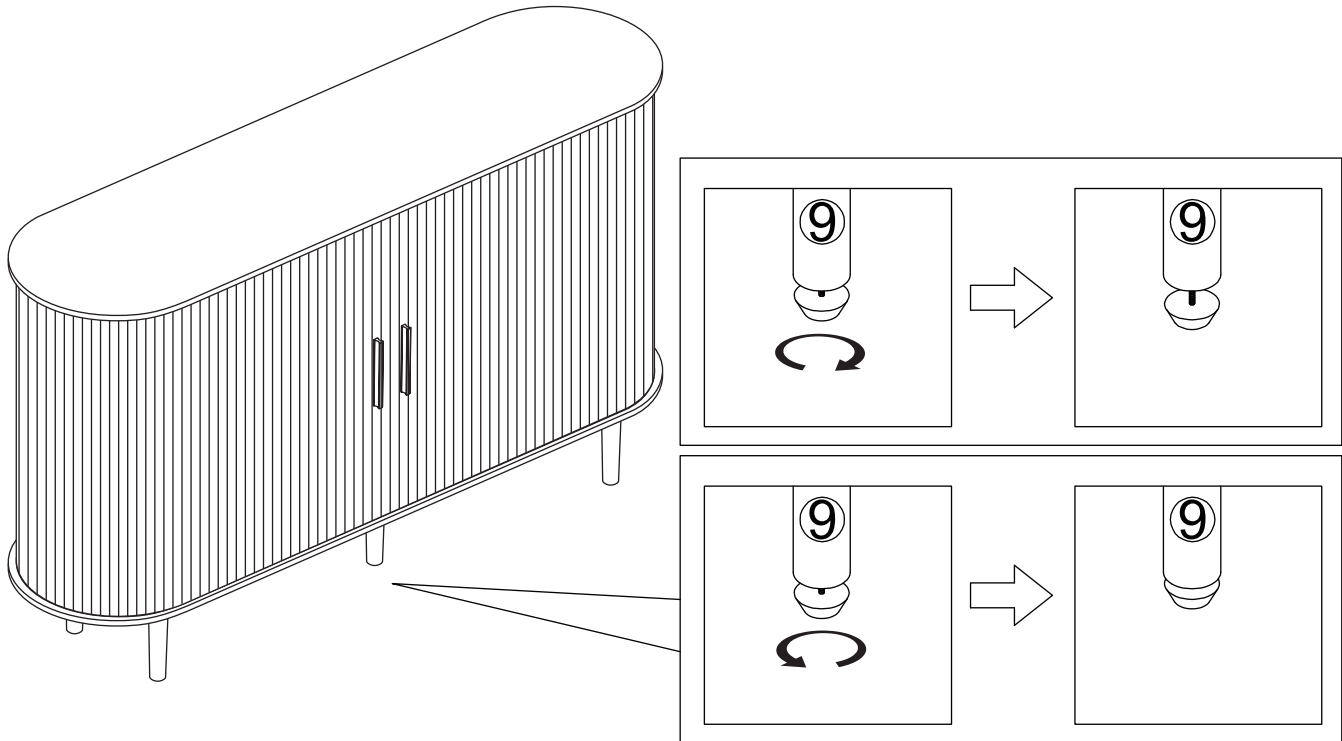
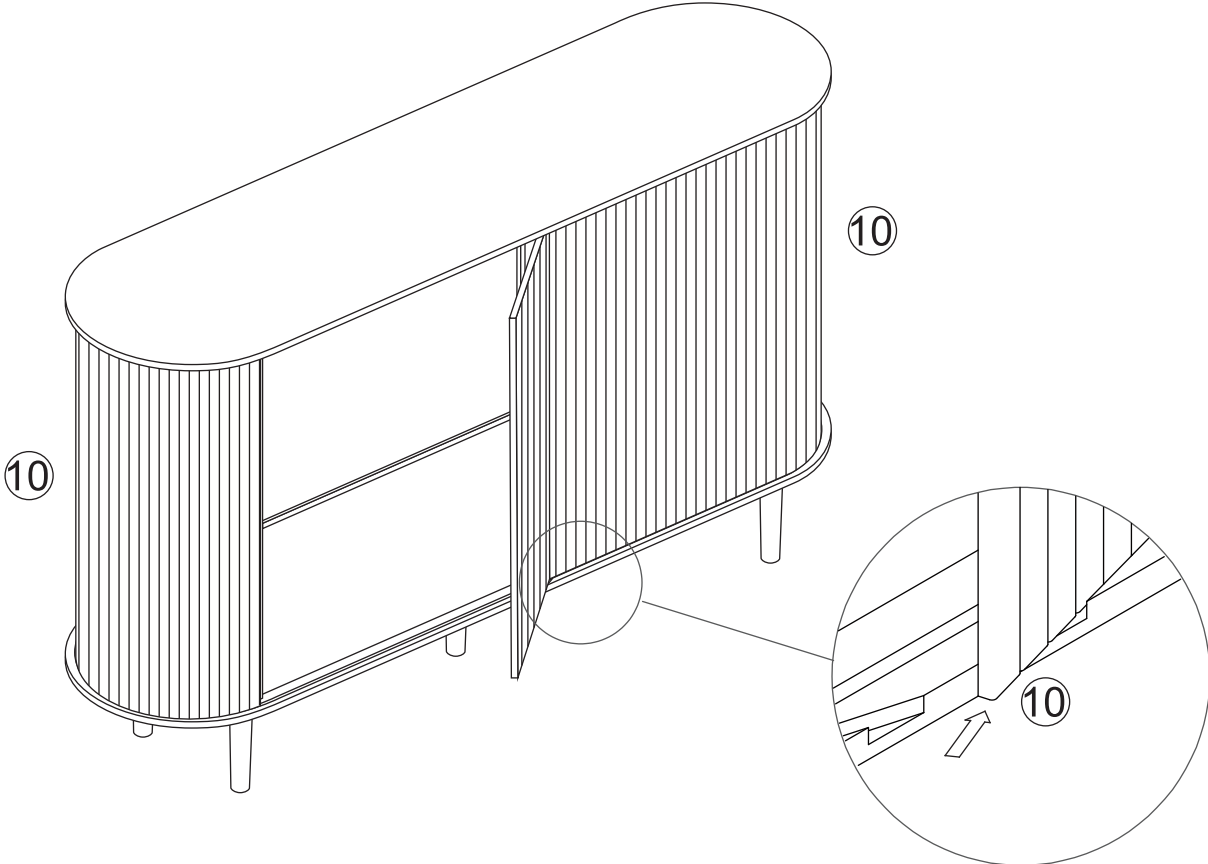

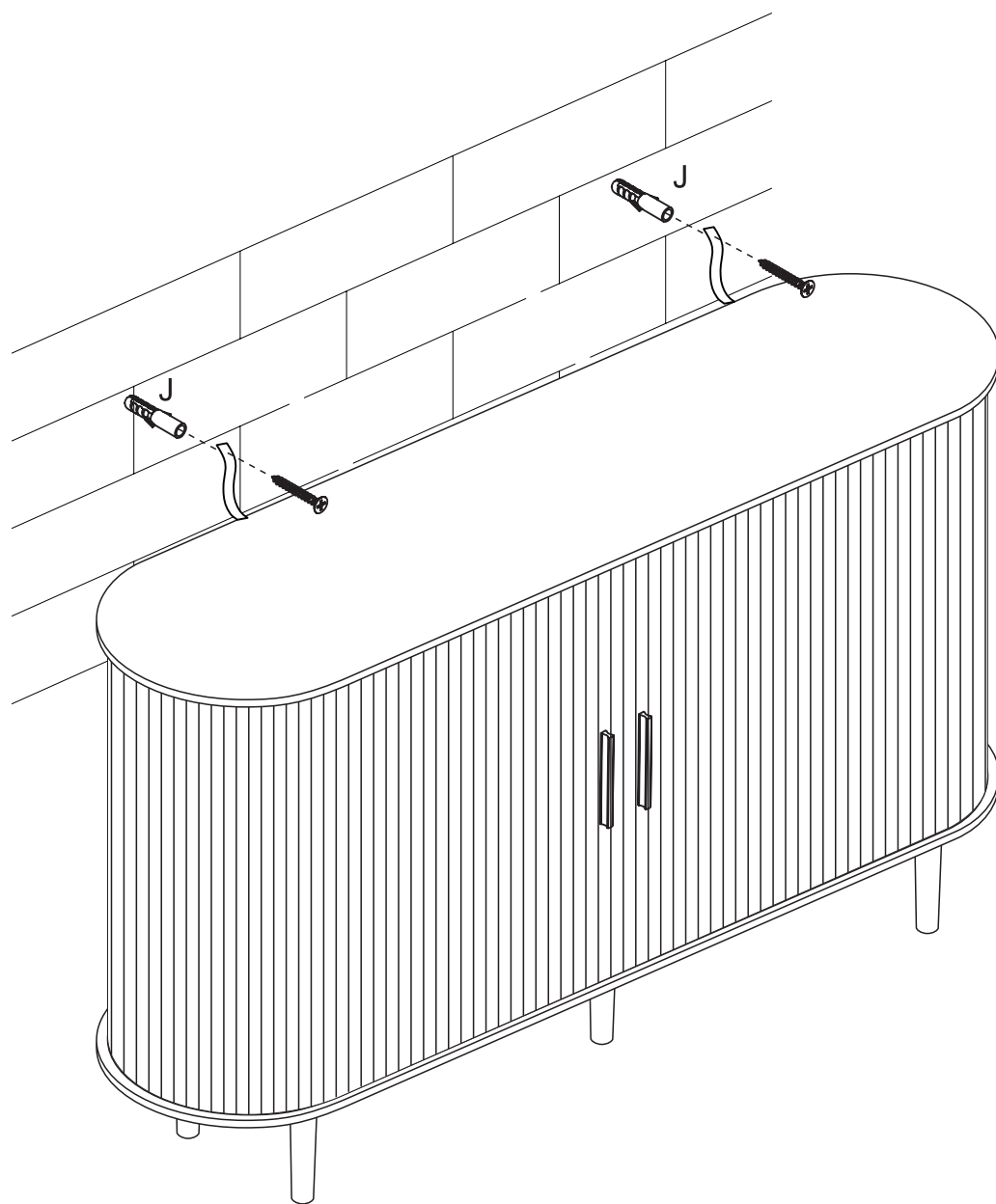
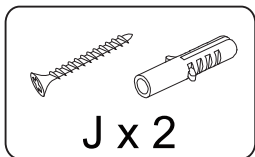



If you have any questions, please contact our customer care center, Our contact details are below:

US

 001-877-644-9366

 customerservice@aosom.com

Imported by Aosom LLC
7777 Center Ave. Suite 430
Huntington Beach, CA 92647-9998 USA
MADE IN CHINA

If you have any questions, please contact our customer care center, Our contact details are below:

UK

 0044-800-240-4004

 enquiries@mhstar.co.uk

IMPORTER ADDRESS:
MH STAR UK LTD
1 Northampton Cross Logistics Park
Northampton Cross Road
Northampton
Nn4 9FH
Tel: 0800 240 4050
enquiries@mhstar.co.uk
MADE IN CHINA

If you have any questions, please contact our customer care center, Our contact details are below:

CA

 416-792-6088

 customerservice@aosom.ca

Imported by Aosom Canada Inc.
Unit 33-1 Sparks Avenue, North York, Ontario,
Canada
M2H 2W1
MADE IN CHINA

Si vous avez la moindre question, veuillez contacter notre centre d'assistance à la clientèle, Nos coordonnées sont les suivantes:

 416-792-6088

 customerservice@aosom.ca

Importé par Aosom Canada Inc.
Unité 33-1 Sparks Avenue, North York, Ontario,
Canada M2H 2W1
Fabriqué en Chine

Wenn Sie Fragen haben, wenden Sie sich bitte an unser Kundendienstzentrum, Unsere Kontaktdaten stehen unten:

DE

 0049-0(40)-87408465

 service@aosom.de

ADRESSE DES IMPORTEUR/Hersteller/REP:
MH Handel GmbH
Wendenstraße 309
D-20537 Hamburg
Germany
IN CHINA HERGESTELLT

In caso di dubbio, si prega di contattare il nostro centro assistenza clienti, I nostri dettagli di contatto sono di seguito:

IT

 0039-0249471447

 clienti@aosom.it

IMPORTATO DA/Produttore/REP:
AOSOM Italy srl
Centro Direzionale Milanofiori
Strada 1 Palazzo F1
20057 Assago (MI)
P.I.: 08567220960
FATTO IN CINA

Si tiene alguna pregunta, comuníquese con nuestro Centro de Atención al Cliente, Nuestros datos de contacto son los siguientes:

ES

 0034-931294512

 atencioncliente@aosom.es

IMPORTADOR/Fabricante/REP:
SPANISH AOSOM, S.L.
C/ROC GROS, Nº15.08550, ELS HOSTALET DE
BALENYÀ, SPAIN.
B66295775
HECHO EN CHINA

Se tiver alguma dúvida, por favor contacte o nosso Centro de Atendimento ao Cliente, Os nossos dados de contacto são os seguintes:

 0034-931294512

 info@aosom.pt.

Importator/Producător/REP:

RO

Aosom Romania SRL
Str. Barbu Mumuleanu, nr. 30-32
Bucuresti, Sector 2
Tel: +40 312294730
clienti@aosom.ro
Fabricat in China

Si vous avez la moindre question, veuillez contacter notre centre d'assistance à la clientèle, Nos coordonnées sont les suivantes:

FR

 0033-1-84166106

 aosom@mhfrance.fr

Importé par/Fabricant/REP:
MH FRANCE
2 Rue Maurice Hartmann
92130 Issy Les Moulineaux
France
FABRIQUÉ EN CHINE



FR

DONNEZ
OU
RECYCLEZ



ASSOCIATION

OU



LIVRAISON

OU



DÉCHÈTERIE

Adresses sur quefairedemesdechets.fr