

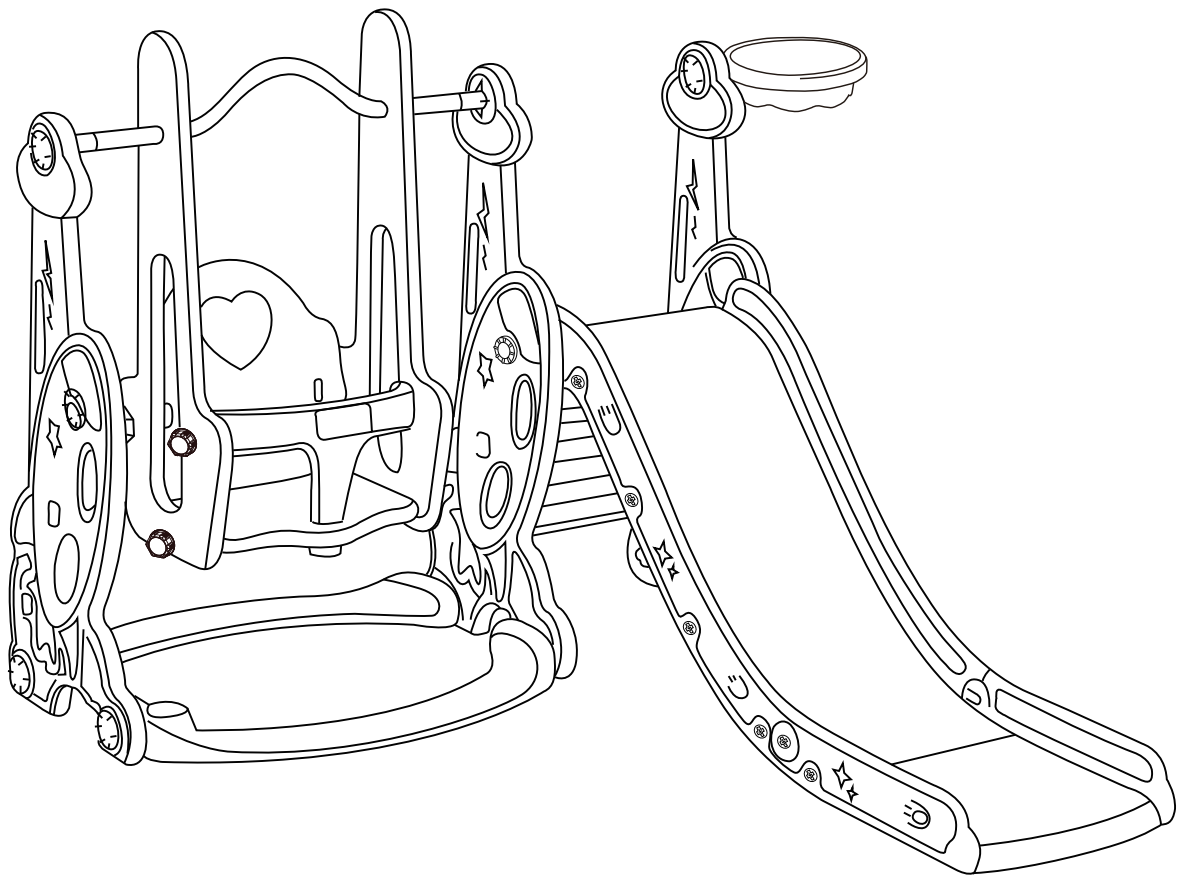

IN240900132V02_US_CA

331-083V00



13
STEPS

60MIN



EN_WARNING: Suitable for children of 18+ months; Max weight: 30 kg.

FR_ATTENTION: Convient aux enfants de 18+ mois; Poids maximum: 30 kg.

EN_IMPORTANT, RETAIN FOR FUTURE REFERENCE: READ CAREFULLY.

FR_IMPORTANT : A LIRE ATTENTIVEMENT ET A CONSERVER POUR VOUS Y REFERER ULTERIEUREMENT.

WARNING:

1. Only allowed for adults to install, keep children away.
2. To be used under the direct supervision of an adult.
3. Keep away from fire! Keep away from water!
4. Check all the parts are well connected before use.
5. Regularly check and maintain the main components (suspenders, fasteners, fixings, etc.), otherwise it may tip over or cause a fall.
6. Installation area should be as wide as possible, flat and avoid dampness.
7. Place the activity toy on a level surface at least 2 m from any structure or obstruction such as a fence, garage, house, overhanging branches, laundry lines or electrical wires.
8. Check all nuts and bolts for tightness and tighten when required.
9. This toy is intended for indoor use.
10. **Warning.** Only for domestic use.

MAINTENANCE & CARE

- A. Keep all instructions and parts relating to this product for future reference.
- B. Please wipe the surface stains of product with a dry cloth. If necessary, use mild soap or detergent to clean them. After wiping with a soft wet cloth, wipe them with a dry cloth. Do not use a strong acid-alkaline cleaning solution to clean them.
- C. If not used for a long time, please put it in a cool and dry place and cover it with clean cloth or blanket.

ATTENTION :

1. Installation par des adultes uniquement, tenir les enfants à l'écart.
2. À utiliser sous la surveillance directe d'un adulte.
3. Loin du feu ! Loin de l'eau !
4. Vérifiez que toutes les pièces sont bien connectées avant utilisation.
5. Vérifiez et entretenez régulièrement les principaux composants (bretelles, attaches, fixations,), sinon il peut se renverser ou provoquer une chute.
6. La zone d'installation doit être aussi large que possible, plate et éviter l'humidité.
7. Placez le jouet d'activité sur une surface plane à au moins 2 m de toute structure ou obstruction telle qu'une clôture, un garage, une maison, des branches en surplomb, des cordes à linge ou des fils électriques.
8. Vérifiez l'étanchéité de tous les écrous et boulons et serrez-les au besoin.
9. Ce jouet est destiné à un usage en intérieur.
10. **Attention.** Réservé à un usage familial.

ENTRETIEN ET MAINTENANCE

- A. Conservez toutes les instructions et les pièces relatives à ce produit pour pouvoir vous y référer ultérieurement.
- B. Veuillez essayer les taches de surface du produit avec un chiffon sec. Si nécessaire, utilisez du savon doux ou du détergent pour le nettoyage. Après l'essuyage avec un chiffon doux et humide, essuyez-les avec un chiffon sec. N'utilisez pas une solution nettoyante fortement acide-alkaline pour le nettoyage.
- C. Si vous ne l'utilisez pas pendant une longue période, placez-le dans un endroit frais et sec et couvrez-le d'un tissu ou d'une couverture propre.

A x 3

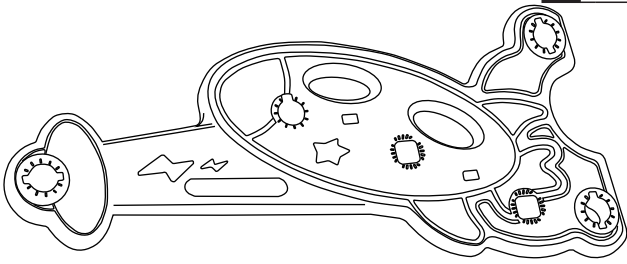

B x 2

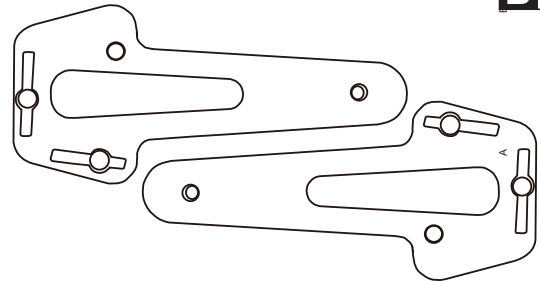

C x 2

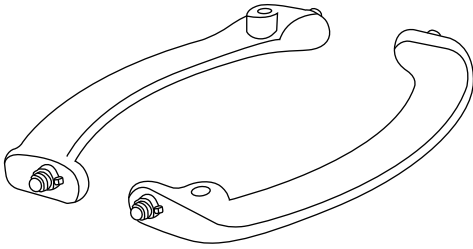

D x 1

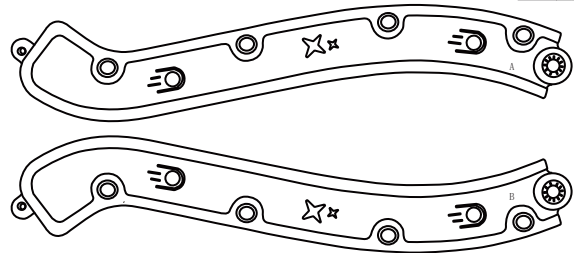

E x 1

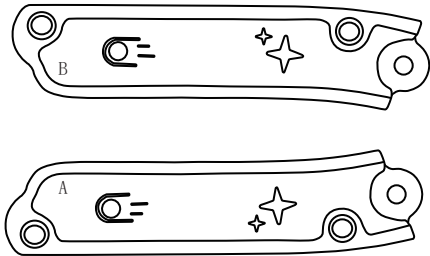

F x 1

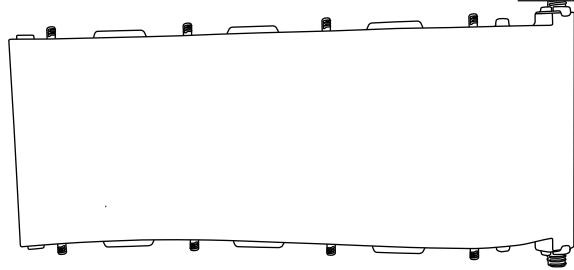

G x 1

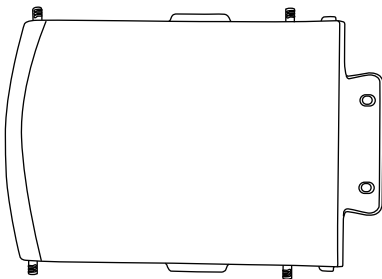

H x 1

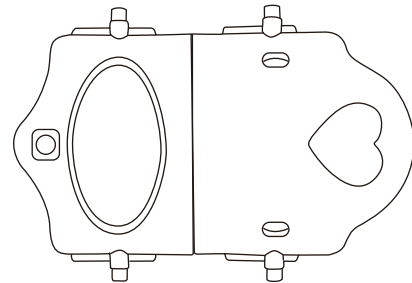

I x 1

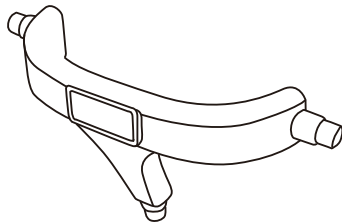

K x 2

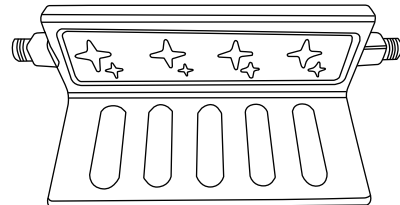



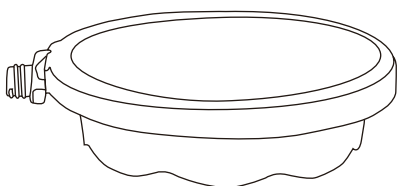



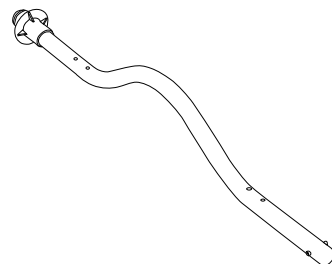

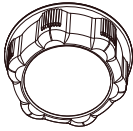

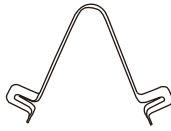

M x 1

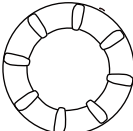
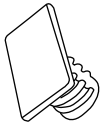

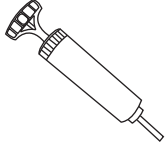
N x 1



 <p>O x 11 +1(spare)</p>	 <p>P x 4 +1(spare)</p>	 <p>Q x 1 +1(spare)</p>
 <p>R x 1</p>	 <p>S x 1</p>	 <p>T x 14 +1(spare)</p>
 <p>U x 9 +1(spare)</p>	 <p>V x 2 +1(spare)</p>	 <p>W x 1</p>
 <p>X x 1</p>	 <p>Y x 2</p>	

<p>T x 2</p>	<p>V x 2</p>
	

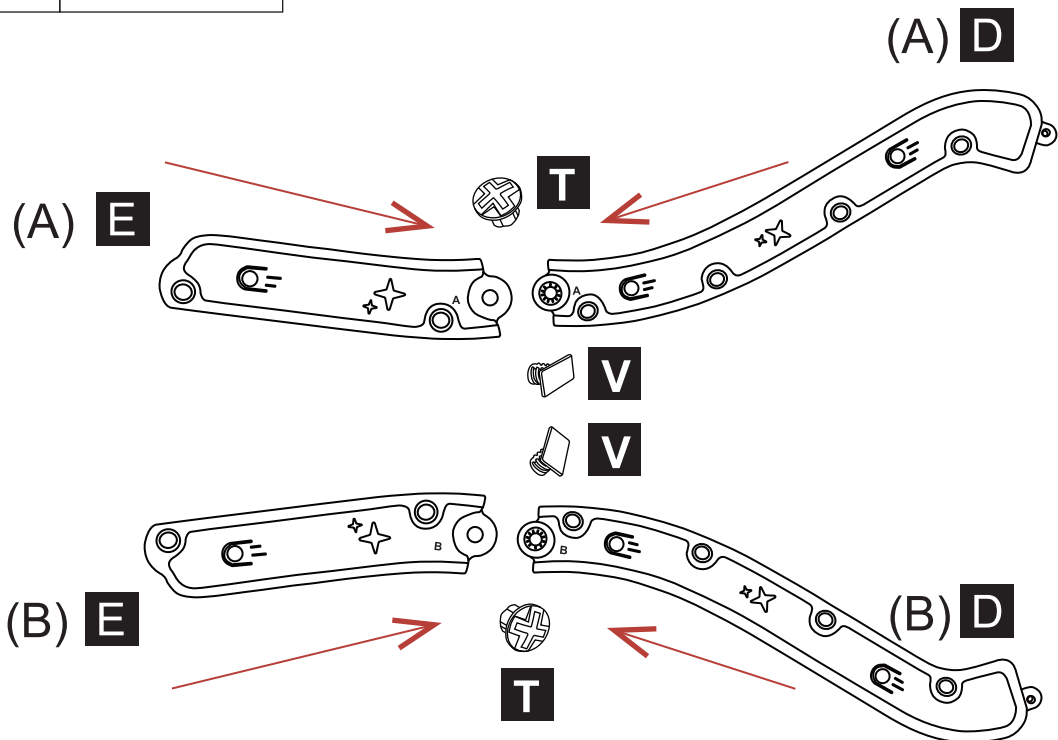

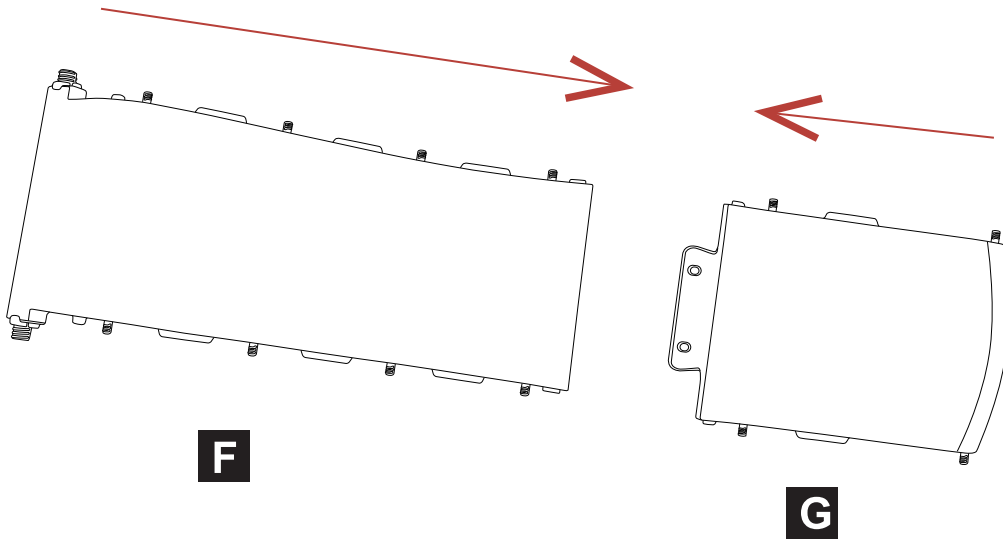

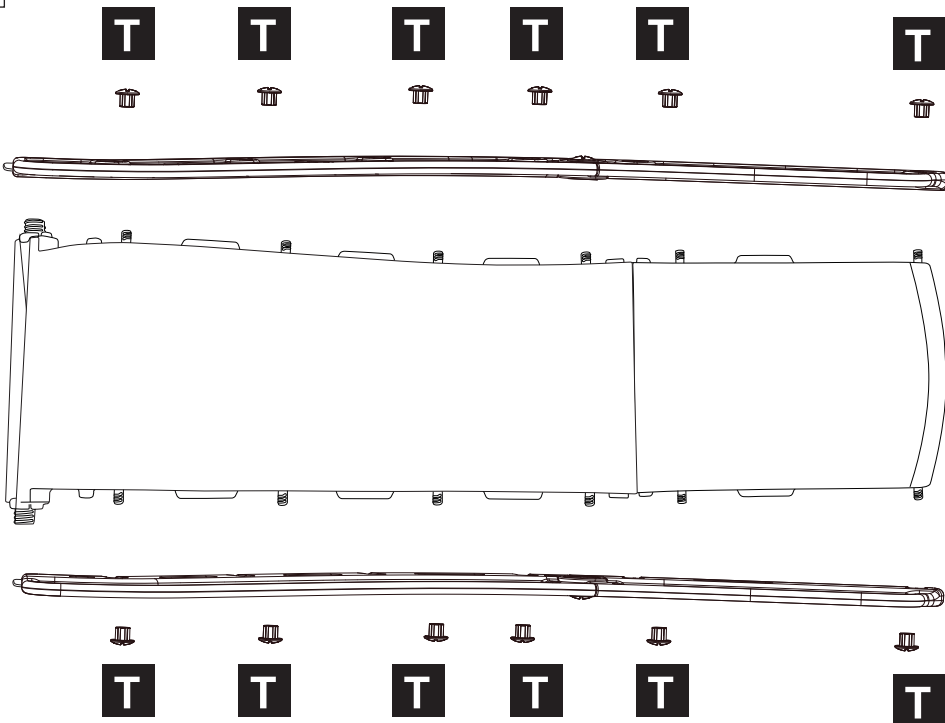

T X12

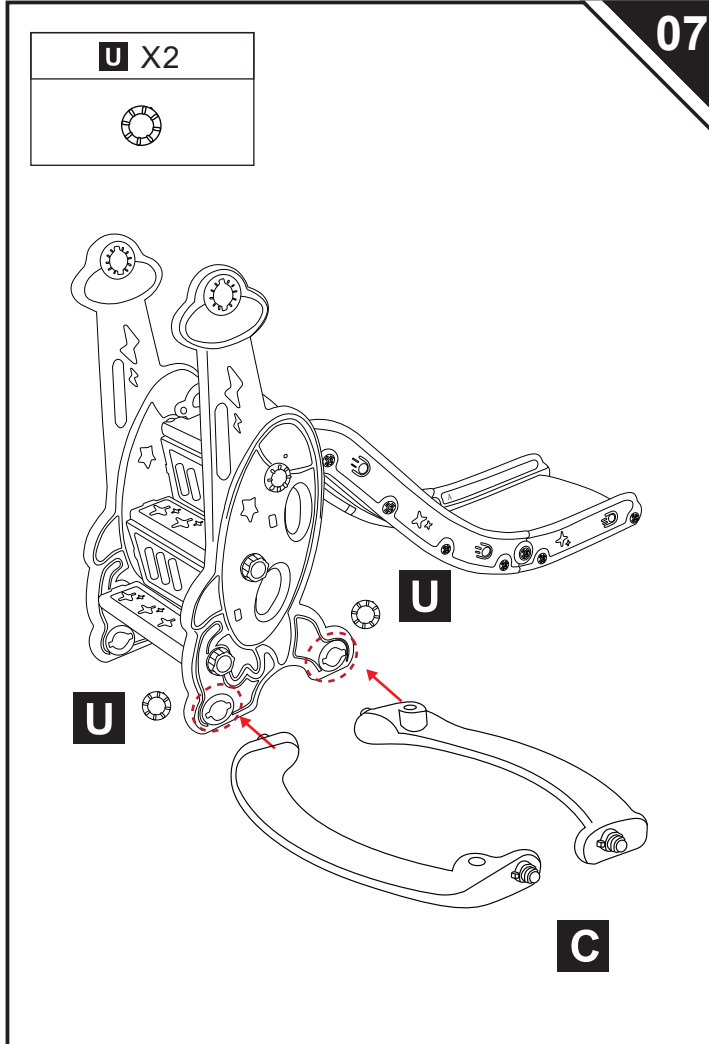
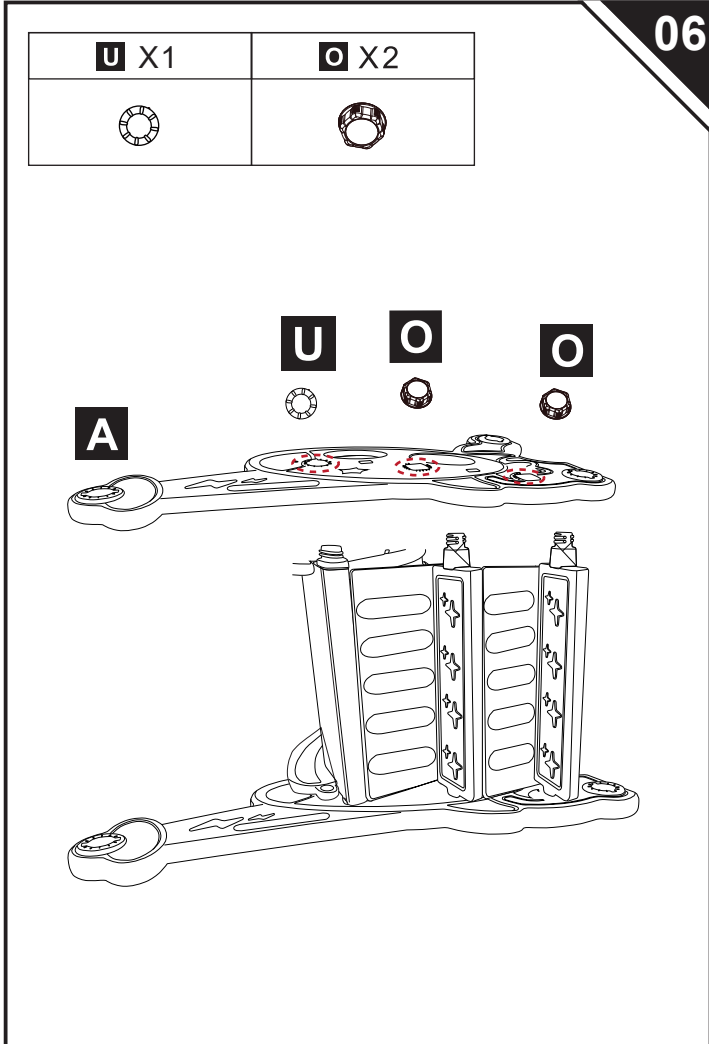
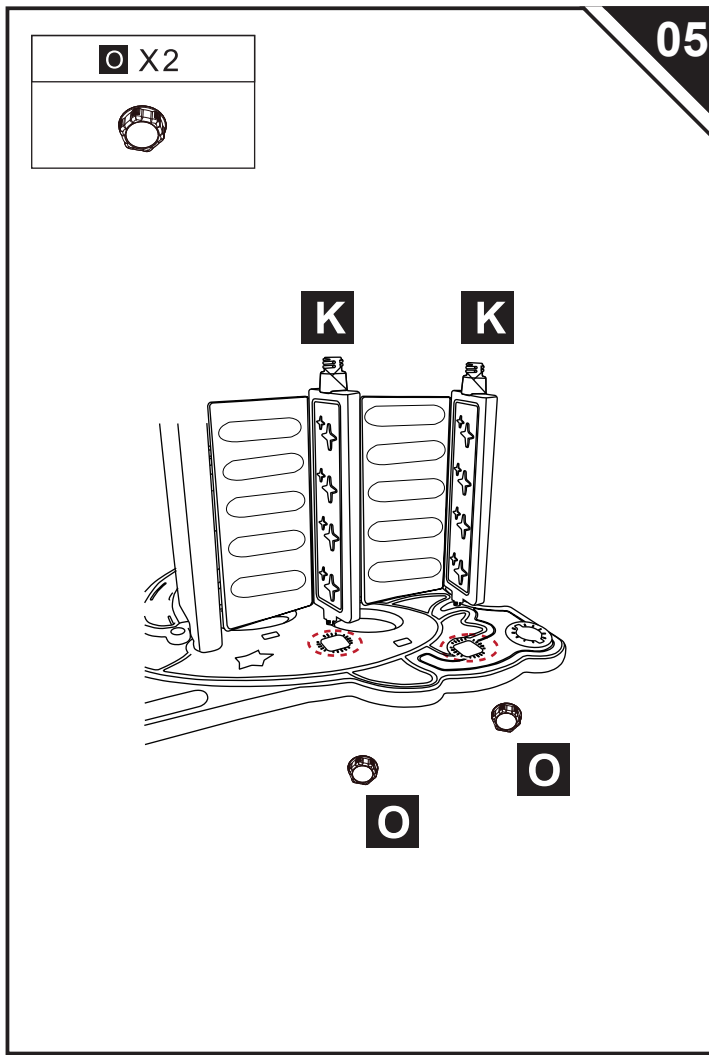
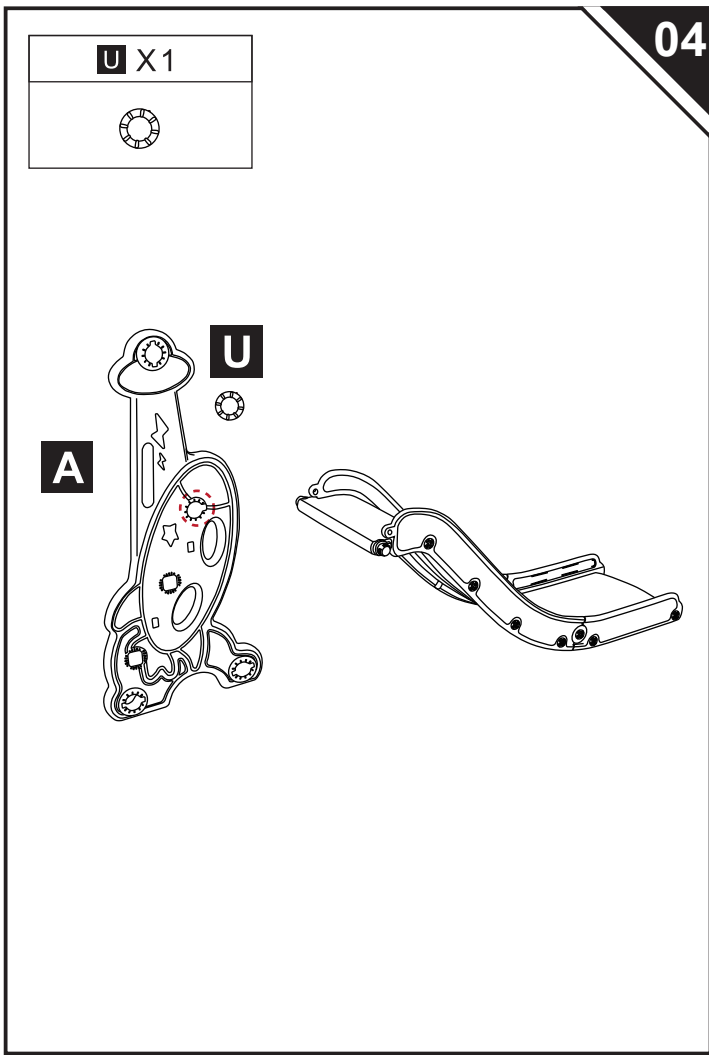

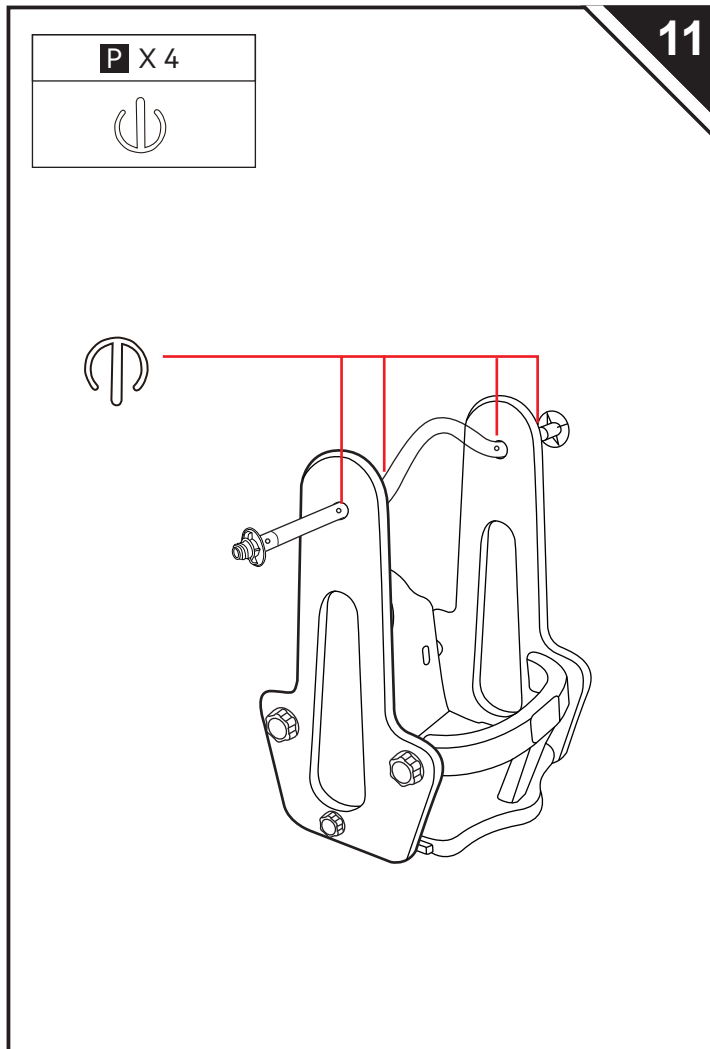
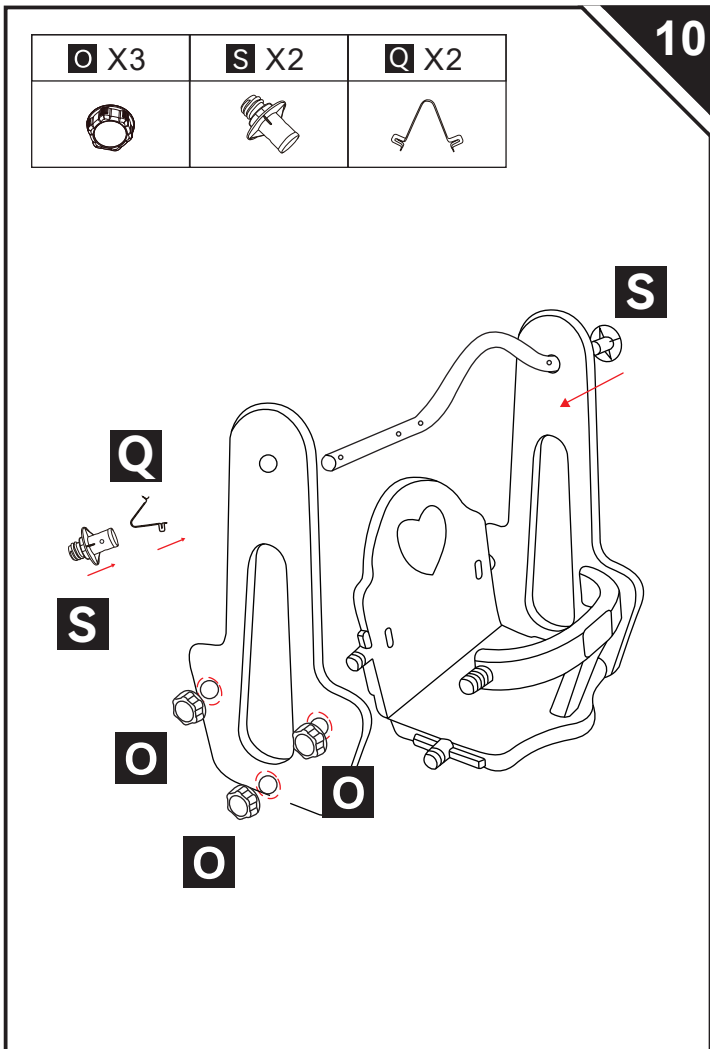
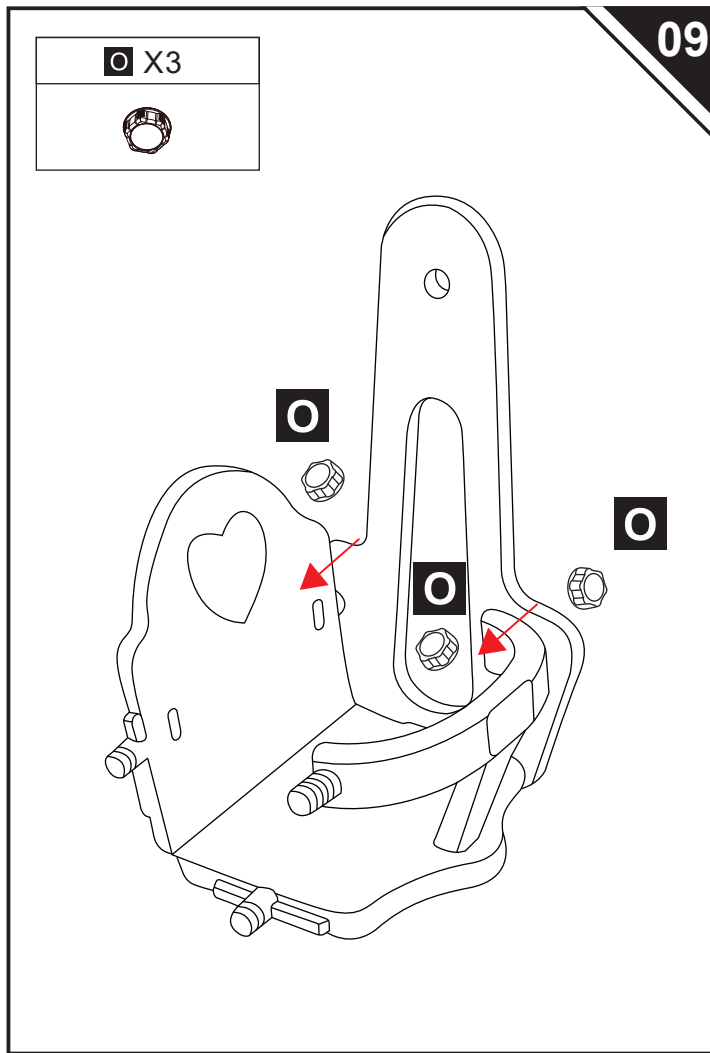
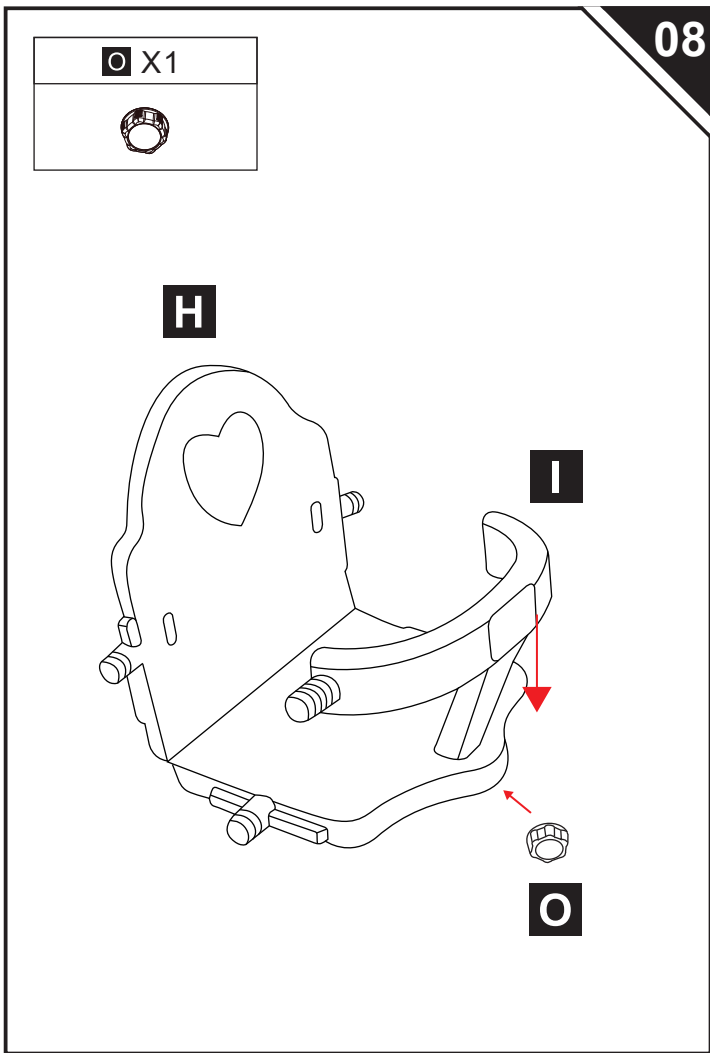



U X5

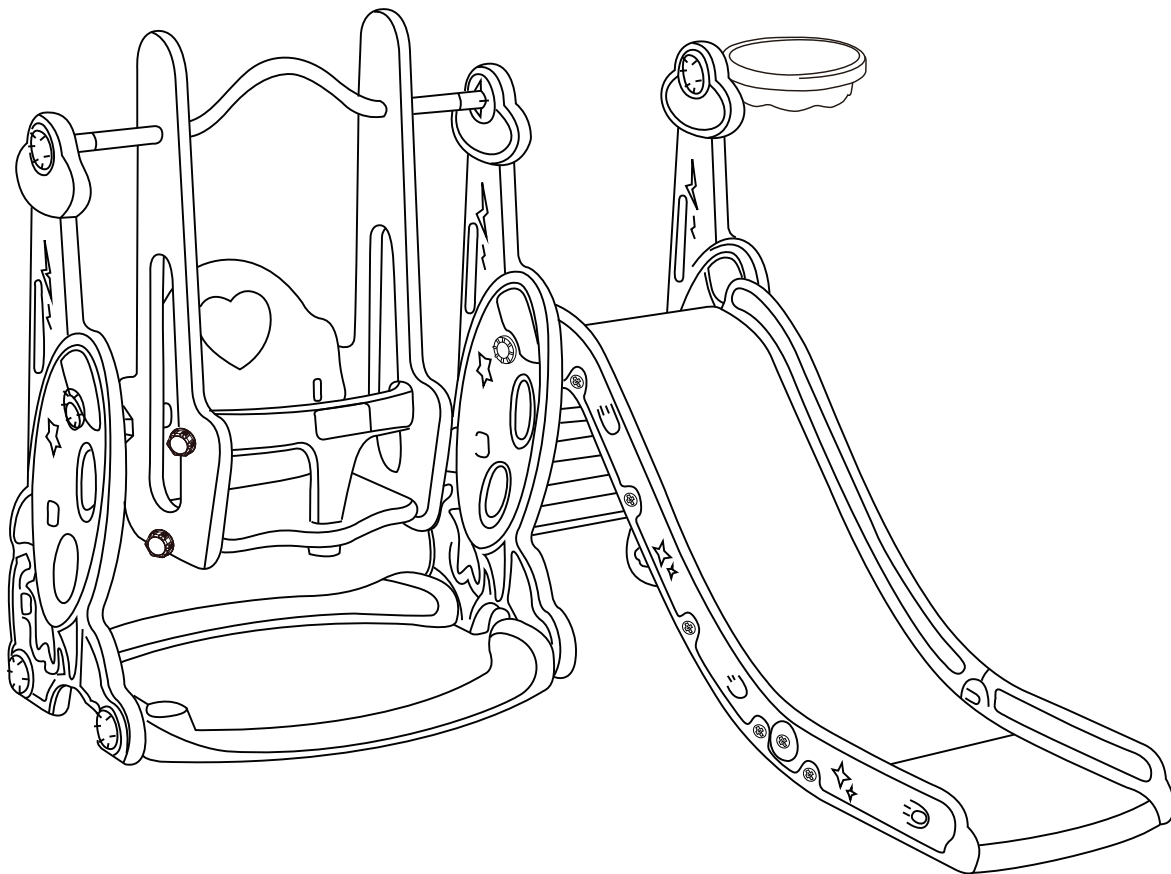
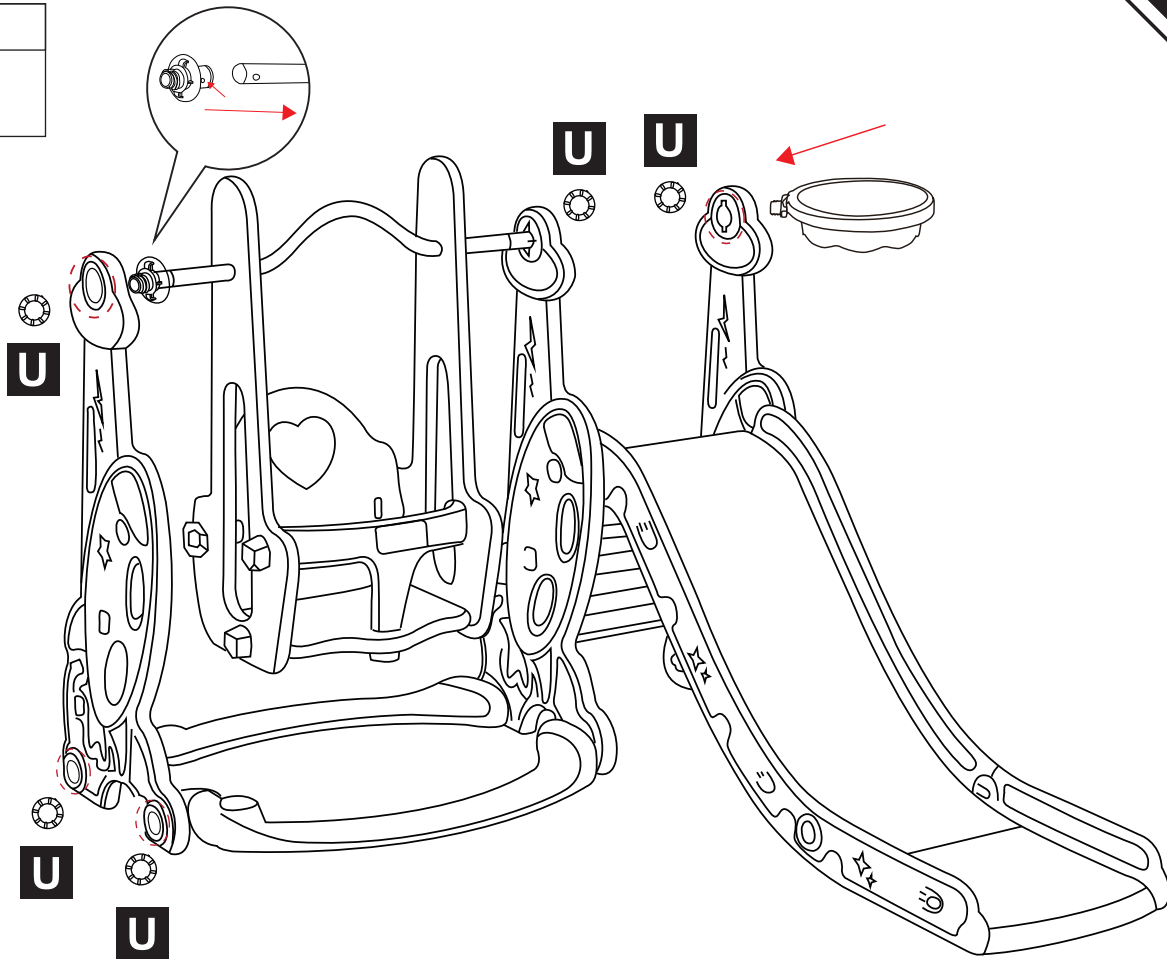

US

If you have any questions, please contact our customer care center.
Our contact details are below:



001-877-644-9366



customerservice@aosom.com

Imported by Aosom LLC
7777 Center Ave. Suite 430
Huntington Beach, CA 92647-9998 USA
MADE IN CHINA

CA

If you have any questions, please contact our customer care center.
Our contact details are below:

Si vous avez la moindre question, veuillez contacter notre centre d'assistance à la clientèle.
Nos coordonnées sont les suivantes:



416-792-6088



customerservice@aosom.ca

Imported by Aosom Canada Inc.
7270 Woodbine Avenue, Unit 307, Markham, Ontario Canada
L3R 4B9
MADE IN CHINA

Importé par Aosom Canada Inc.
7270 Woodbine Avenue, unité 307, Markham, Ontario Canada
L3R 4B9
FABRIQUÉ EN CHINE

