

**EN\_ IMPORTANT, RETAIN FOR FUTURE REFERENCE: READ CAREFULLY.**

**FR\_ IMPORTANT: A LIRE ATTENTIVEMENT ET À CONSERVER POUR CONSULTATION ULTÉRIEURE.**

**ES\_ IMPORTANTE, LEA Y GUARDE PARA FUTURAS REFERENCIAS.**

**PT\_ IMPORTANTE: LEIA ATENTAMENTE E GUARDE PARA CONSULTA FUTURA.**

**DE\_ WICHTIG! SORGFÄLTIG LESEN UND FÜR SPÄTER NACHSCHLAGEN AUFBEWAHREN.**

**IT\_ IMPORTANTE! CONSERVARE IL PRESENTE MANUALE PER FUTURO RIFERIMENTO E LEGGERLO ATTENTAMENTE.**

**RO\_ IMPORTANT: CITIȚI CU ATENȚIE ȘI PĂSTRAȚI PENTRU CONSULTARE VIITOARE.**



**EN\_ QUICKFIT:** Tighten quickfit until shoulder is flush with panel. Do not overtighten or undertighten.

**FR\_ RACCORD RAPIDE:** Faites serrer le raccord rapide jusqu'à ce que l'épaulement soit parfaitement encastré dans le panneau. Il ne faut ni trop serrer ni insuffisamment serrer.

**ES\_ QUICKFIT:** Apriete quickfit hasta que el hombro se descargue con el panel. NO lo sobreapriete ni lo apriete poco.

**PT\_ AJUSTE RÁPIDO:** Aperte o ajuste rápido até estar nivelada com o painel. Não apertar demasiado ou excessivamente.

**DE\_ QUICKFIT:** Ziehen Sie den Quickfit fest, bis die Schulter mit der Platte bündig ist. Bitte nicht zu fest oder zu schwach anziehen.

**IT\_ MONTAGGIO RAPIDO:** Stringere il montaggio rapido fino a quando la spalla è a filo con il pannello, non stringere troppo o troppo poco.

**RO\_ QUICKFIT:** Strângeți quickfit până când umărul este la același nivel cu panoul. Nu strângeți prea tare și nici prea slab.



**EN\_ CAM LOCK:** When fitting cam lock, ensure starting position is correct before you insert connecting quickfit.

**FR\_ SERRURE BATTEUSE:** Avant d'insérer la serrure batteuse, veillez à la bonne orientation avant d'insérer le raccord rapide.

**ES\_ CIERRE DE LA CÁMARA:** Cuando instale el cierre de la cámara, asegúrese de que la posición de inicio es correcta antes de que inserte el quickfit conector.

**PT\_ BLOQUEIO:** Ao instalar o bloqueio, assegurar-se de que a posição inicial está correcta antes de inserir o encaixe de ligação rápida.

**DE\_ CAM-LOCK:** Achten Sie bei der Montage des Cam-Locks auf die richtige Ausgangsposition, bevor Sie den Quickfit einsetzen.

**IT\_ BLOCCAGGIO A CAMMA:** Quando si monta il bloccaggio a camma, assicurarsi che la posizione iniziale sia corretta prima di inserire il montaggio rapido di collegamento.

**RO\_ BLOCARE CU CAME:** Când montați blocarea cu came, asigurați-vă că poziția inițială este corectă înainte de a introduce racordul rapid.

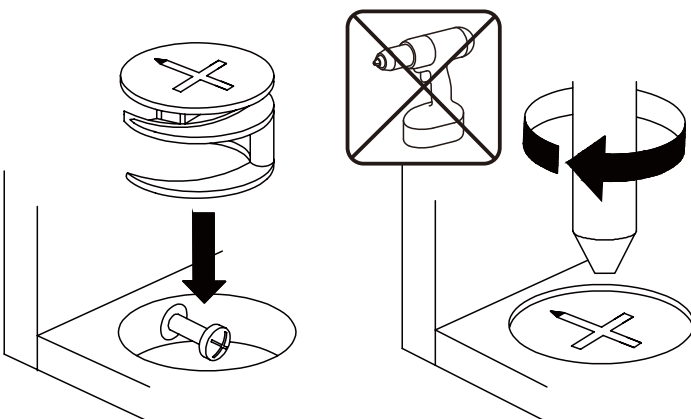

**EN\_** Turn cam lock clockwise to tighten.

**FR\_** Faites tourner la serrure batteuse dans le sens des aiguilles d'une montre pour la resserrer.

**ES\_** Gire el cierre de la cámara en sentido horario para apretarlo.

**PT\_** Rodar o bloqueio no sentido dos ponteiros do relógio para o apertar.

**DE\_** Drehen Sie den Cam-Lock im Uhrzeigersinn, um ihn festzuziehen.

**IT\_** Ruotare il bloccaggio a camma in senso orario per stringere.

**RO\_** Rotiți blocarea cu came în sensul acelor de ceasornic pentru a strânge.

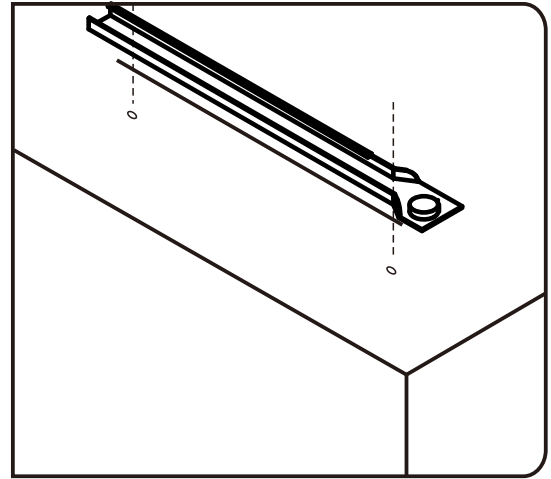
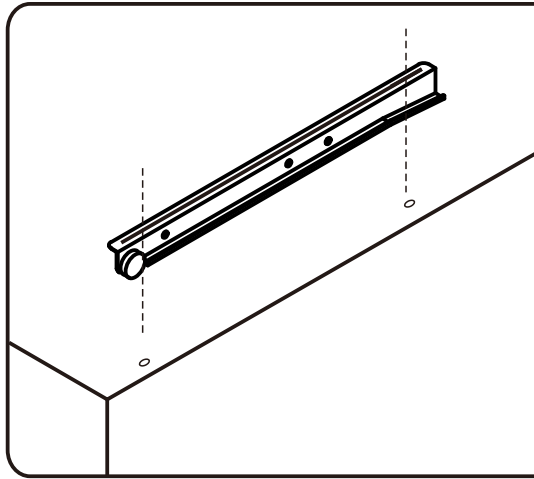
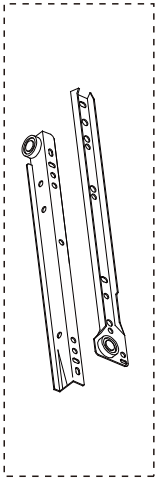

**EN\_** Please find the exact hole for installation, otherwise it will be misaligned. The screws on the drawer slide must be leveled, otherwise it will affect the smoothness of the drawer.

**FR\_** Identifiez le trou exact pour l'installation, sinon il sera mal aligné. Les vis de la glissière du tiroir doivent être nivelées, sinon cela affectera le fonctionnement du tiroir.

**ES\_** Al instalar, encuentre el orificio exacto; de lo contrario, estará desalineado. Los tornillos en las correderas del cajón deben estar nivelados, de lo contrario, afectará la suavidad al deslizar el cajón.

**PT\_** Por favor encontre o orifício exacto para instalação, caso contrário será desalinhado. Os parafusos na corrediça da gaveta devem ser nivelados, caso contrário afetará a suavidade da abertura da gaveta.

**DE\_** Bitte finden Sie das genaue Loch für die Installation, sonst wird es falsch ausgerichtet werden. Die Schrauben an der Schubladenführung müssen nivelliert werden, da sonst die Leichtgängigkeit der Schublade beeinträchtigt wird.

**IT\_** individuare il foro esatto per l'installazione, altrimenti ci sarà un disallineamento. Le viti sulla guida del cassetto devono essere allineate, altrimenti influirà sulla scorrevolezza del cassetto.

**RO\_** Găsiți orificiul exact pentru instalare, altfel acesta va fi aliniat incorect. Șuruburile de pe glisiera sertarului trebuie să fie nivelate, altfel aceasta va afecta funcționarea lină a sertarului.

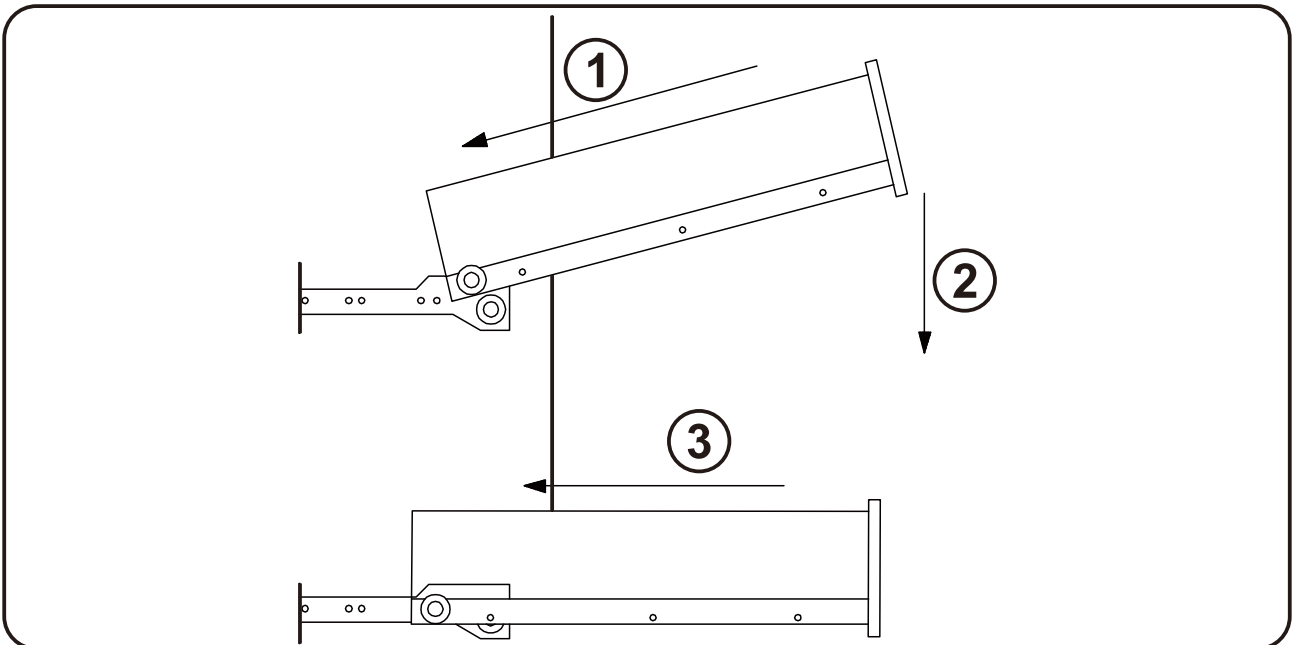

**EN\_** Be careful to push in the board when the both sides slide way been aligned.

**FR\_** Prenez soin d'enfoncer la planche lorsque les deux côtés de la glissière sont alignés.

**ES\_** Empuje con cuidado el tablero después de que los dos lados se hayan alineado.

**PT\_** Ter o cuidado de empurrar a placa quando os dois lados estiverem alinhados.

**DE\_** Achten Sie darauf, dass Sie die Platte einschieben, wenn die beiden Seiten so ausgerichtet sind, dass sie gleiten.

**IT\_** Fare attenzione quando si spinge il cassetto quando le due guide di scorrimento sono state allineate.

**RO\_** Aveți grijă să împingeți placa atunci când ambele părți sunt aliniate.

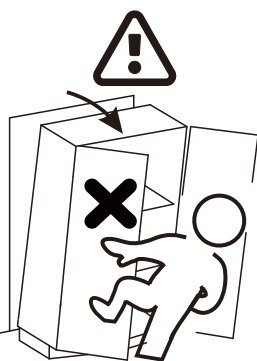
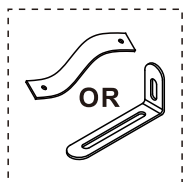

**EN\_** This is anti-dumping belt that fix the product to the wall and it can be used or not follow your needs.

**FR\_** Cette sangle anti-basculement permet de fixer le produit au mur. Elle peut être utilisée ou non selon vos besoins.

**ES\_** Esta es una correa anti-vuelco para fijar el producto a la pared, y según sus necesidades, puede utilizarla o no.

**PT\_** Este é o sistema anti-tombo que fixa o produto à parede e pode ser usado para uma maior segurança.

**DE\_** Dies ist Anti-Sturz-Gurt, um das Gerät an der Wand zu befestigen und es kann je nach Bedarf verwendet oder nicht verwendet werden.

**IT\_** Questa è una cintura anticaduta che fissa il prodotto alla parete e può essere utilizzata o meno a seconda delle vostre esigenze.

**RO\_** Aceasta este o centură anti-dumping care fixează produsul pe perete și poate fi utilizată sau nu, în funcție de necesități.

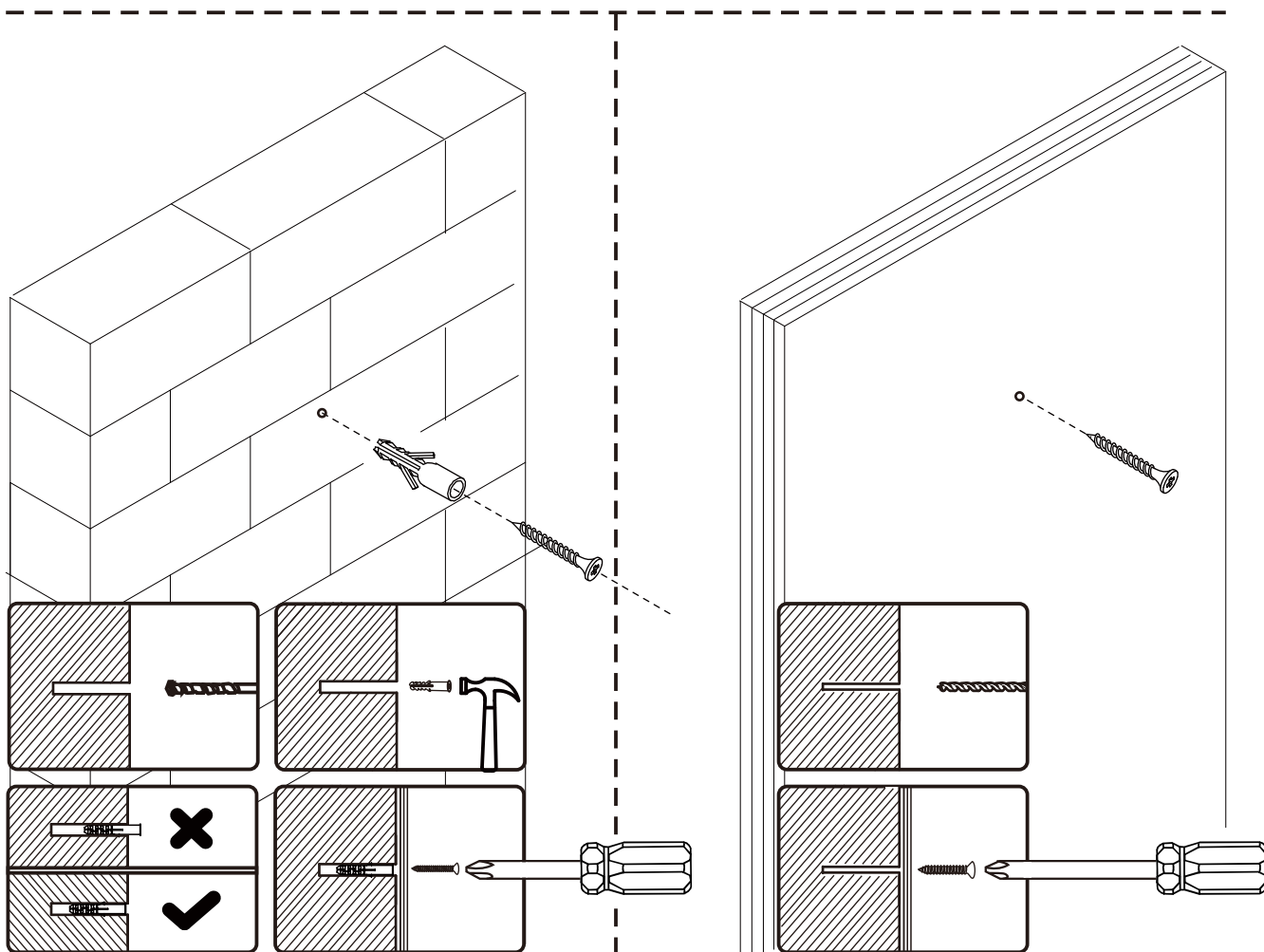

**EN\_** If it is a solid wall, please use expansion and self-tapping screws, if it is a wooden wall, only use self-tapping screws, please do not overtighten the screws

**FR\_** Si le mur est massif, veuillez utiliser des chevilles à expansion et des vis autotaraudeuses, mais s'il s'agit d'un mur en bois, utilisez uniquement des vis autotaraudeuses et ne serrez pas trop les vis.

**ES\_** Para una pared sólida, utilice los tornillos de expansión y autorroscantes. Para una pared de madera, utilice exclusivamente los tornillos autorroscantes, no los apriete demasiado.

**PT\_** Se for uma parede sólida, use por favor parafusos de expansão e auto-roscantes, se for uma parede de madeira, use apenas parafusos auto-roscantes, por favor não aperte demasiado os parafusos.

**DE\_** Wenn es sich um eine Massivwand handelt, verwenden Sie bitte Dehnungs- und selbstschneidende Schrauben. Wenn es sich um eine Holzwand handelt, verwenden Sie nur selbstschneidende Schrauben, bitte ziehen Sie die Schrauben nicht zu fest an.







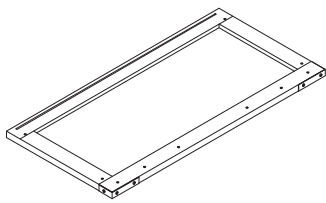
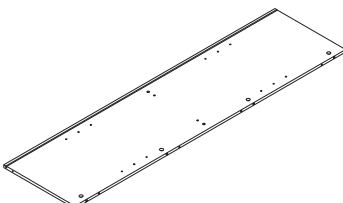
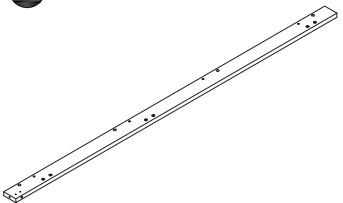
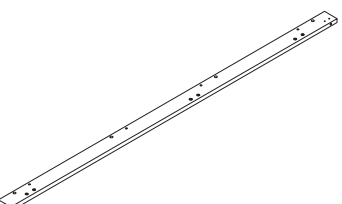
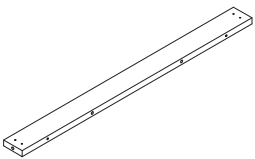
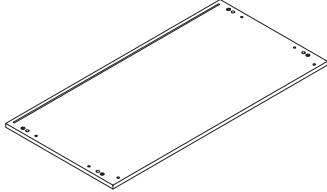
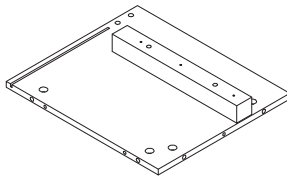
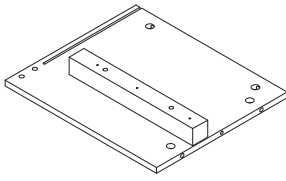
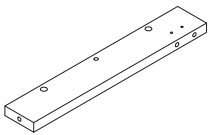
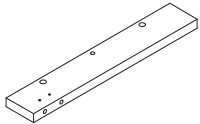
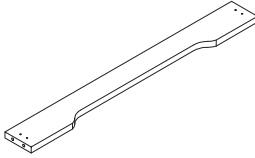
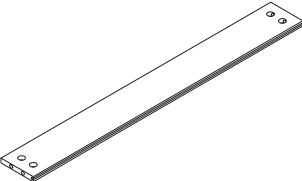
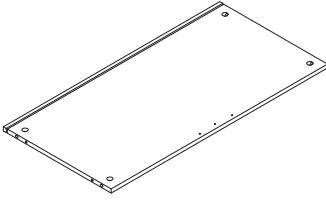
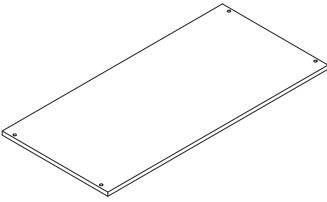
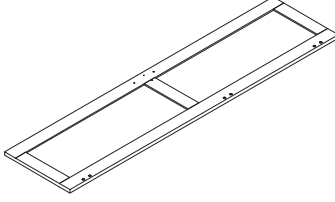
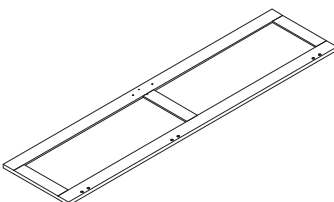
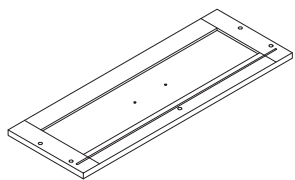
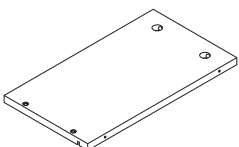
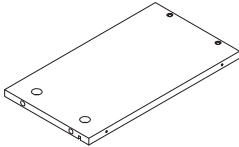
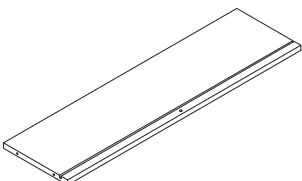
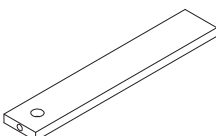
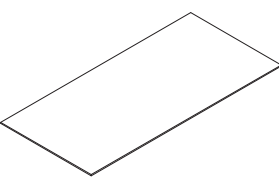
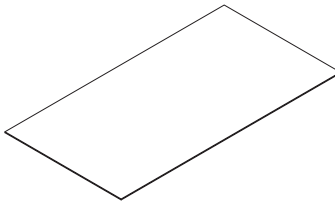
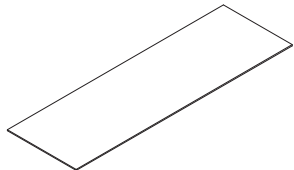



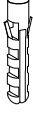

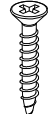
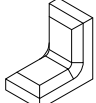
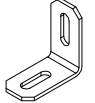

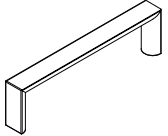
**IT\_** Se si tratta di un muro solido, utilizzare sia viti ad espansione che autofilettanti. Se si tratta di una parete in legno, utilizzare solo viti autofilettanti, non stringere eccessivamente le viti.

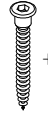
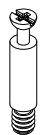
**RO\_** Dacă este un perete solid, vă rugăm să utilizați șuruburi cu expansiune și autofiletante, dacă este un perete din lemn, utilizați numai șuruburi autofiletante, vă rugăm să nu strângeți excesiv șuruburile.

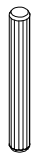
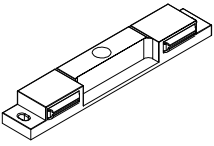
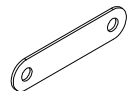
# PARTS LIST

<p>① 1PC</p> 	<p>② 2PCS</p> 	<p>③ 1PC</p> 	<p>④ 1PC</p> 
<p>⑤ 1PC</p> 	<p>⑥ 1PC</p> 	<p>⑦ 1PC</p> 	<p>⑧ 1PC</p> 
<p>⑨ 1PC</p> 	<p>⑩ 1PC</p> 	<p>⑪ 1PC</p> 	<p>⑫ 1PC</p> 
<p>⑬ 1PC</p> 	<p>⑭ 2PCS</p> 	<p>⑮ 1PC</p> 	<p>⑯ 1PC</p> 
<p>⑰ 1PC</p> 	<p>⑱ 1PC</p> 	<p>⑲ 1PC</p> 	<p>⑳ 1PC</p> 
<p>㉑ 1PC</p> 	<p>㉒ 1PC</p> 	<p>㉓ 4PCS</p> 	<p>㉔ 1PC</p> 

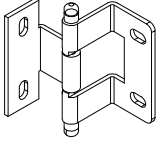
# HARDWARE LIST

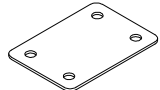
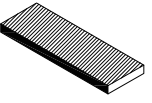
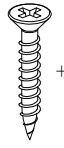
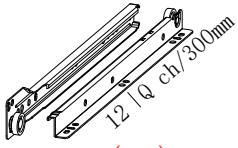
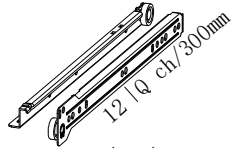
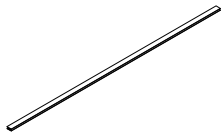
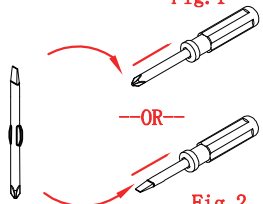
 <p>M4</p> <p><b>Ax1PC</b></p>	   <p>6*25mm      M4      8*M4*25mm</p> <p><b>B1x2PCS   B2x2PCS   B3x2PCS</b></p>			   <p>28*28*18mm    26*26*13.5mm    6*M3*12mm</p> <p><b>C1x2PCS   C2x2PCS   C3x32PCS</b></p>		
 <p><b>D1x3PCS</b></p>	 <p>+1 (spare)</p> <p>M4*20mm</p> <p><b>D2x4PCS</b></p>	 <p>+1 (spare)</p> <p>M5*46mm</p> <p><b>E1x12PCS</b></p>	 <p>+2 (spare)</p> <p>6.5*36mm</p> <p><b>F1x29PCS</b></p>	 <p>+2 (spare)</p> <p>15*9.8mm</p> <p><b>F2x29PCS</b></p>		
 <p>+2 (spare)</p> <p>6*30mm</p> <p><b>Gx26PCS</b></p>	 <p>6*50mm</p> <p><b>Hx2PCS</b></p>	 <p>120*19mm</p> <p><b>I1x1PC</b></p>	 <p>54*12*1mm</p> <p><b>I2x2PCS</b></p>	 <p>+2 (spare)</p> <p>6*M3*16mm</p> <p><b>Jx25PCS</b></p>		
 <p>+2 (spare)</p> <p>14*14*11mm</p> <p><b>Kx22PCS</b></p>	 <p>+1 (spare)</p> <p>5*7.5*21.5mm</p> <p><b>Lx8PCS</b></p>	 <p>64*15*2mm</p> <p><b>Mx6PCS</b></p>	 <p>+2 (spare)</p> <p>M4*8mm</p> <p><b>Nx26PCS</b></p>	 <p>45*32*0.8mm</p> <p><b>Ox4PCS</b></p>		
 <p>30*10*2mm</p> <p><b>Px9PCS</b></p>	 <p>+1 (spare)</p> <p>8*M4*30mm</p> <p><b>Qx5PCS</b></p>	<p><b>R1 (CL) x1PC</b></p>  <p>12   Q ch / 300mm</p> <p><b>R1 (DL) x1PC</b></p>	<p><b>R2 (DR) x1PC</b></p>  <p>12   Q ch / 300mm</p> <p><b>R2 (GR) x1PC</b></p>	 <p>692*14*6mm</p> <p><b>Sx2PCS</b></p>		
 <p>Fig. 1</p> <p>—OR—</p> <p>Fig. 2</p> <p><b>Tx1PC</b></p>						

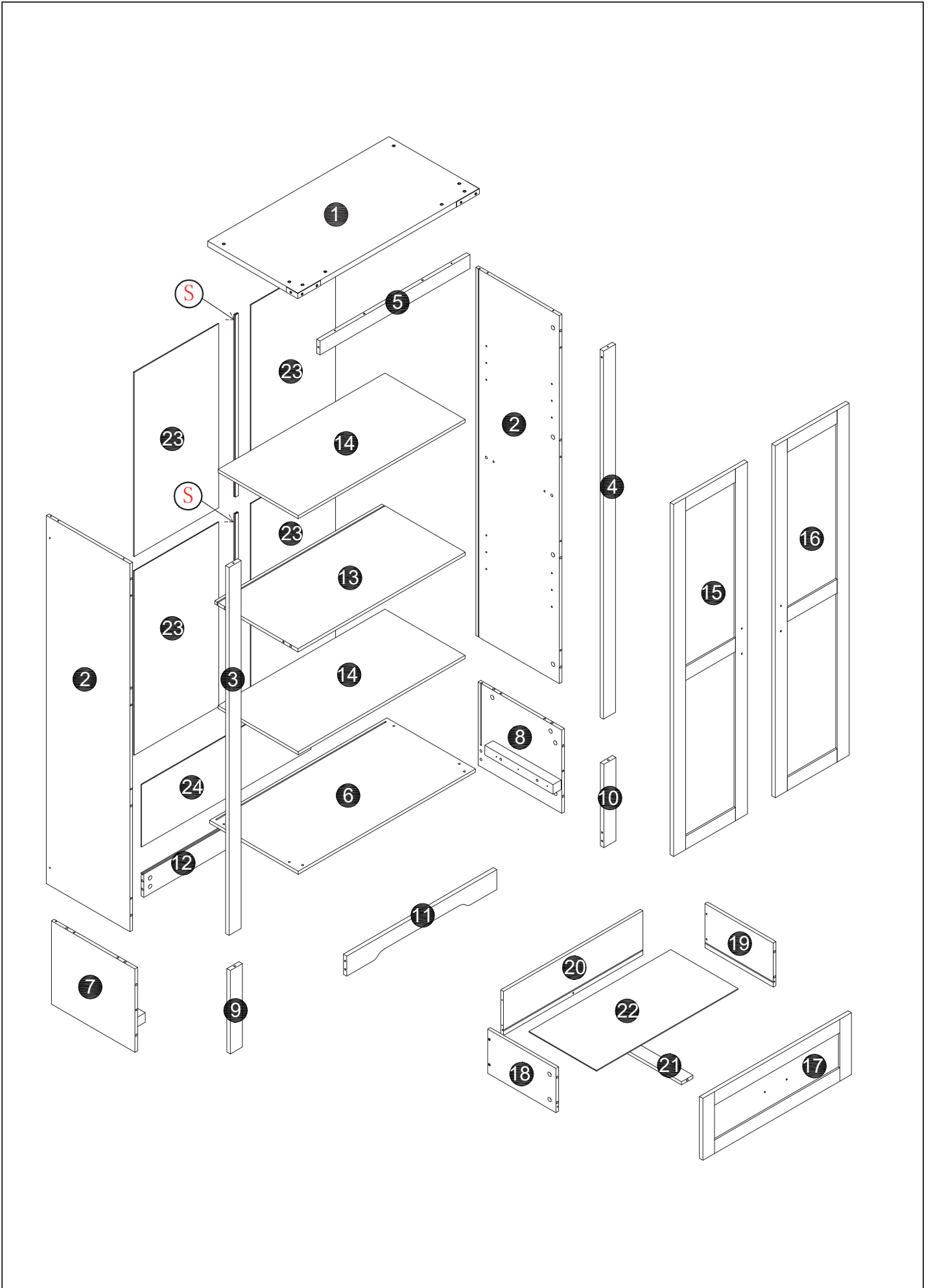

# 1

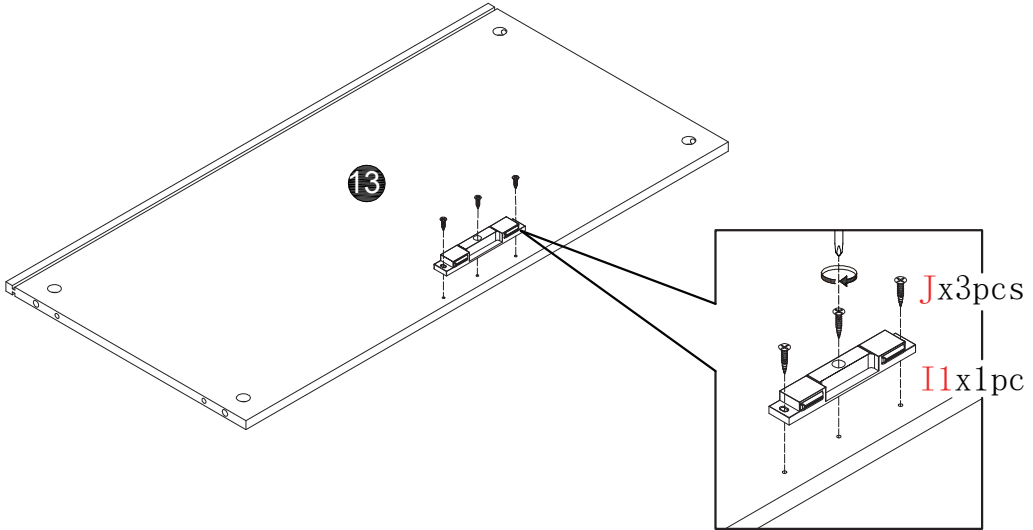
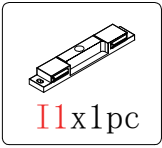

# 2

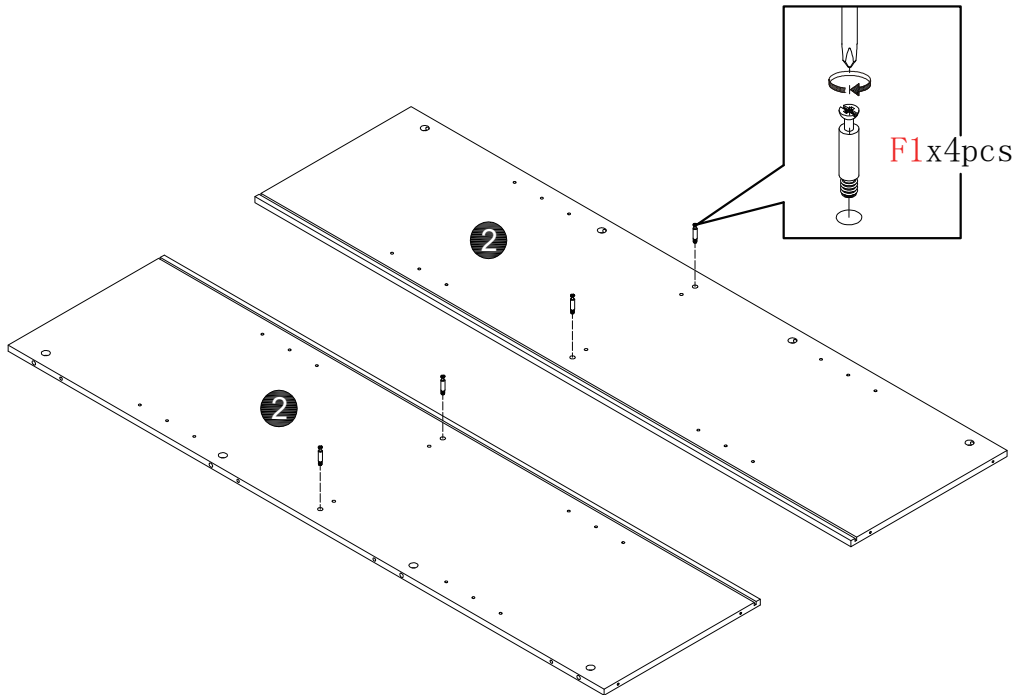
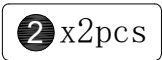
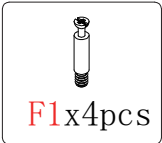

# 3

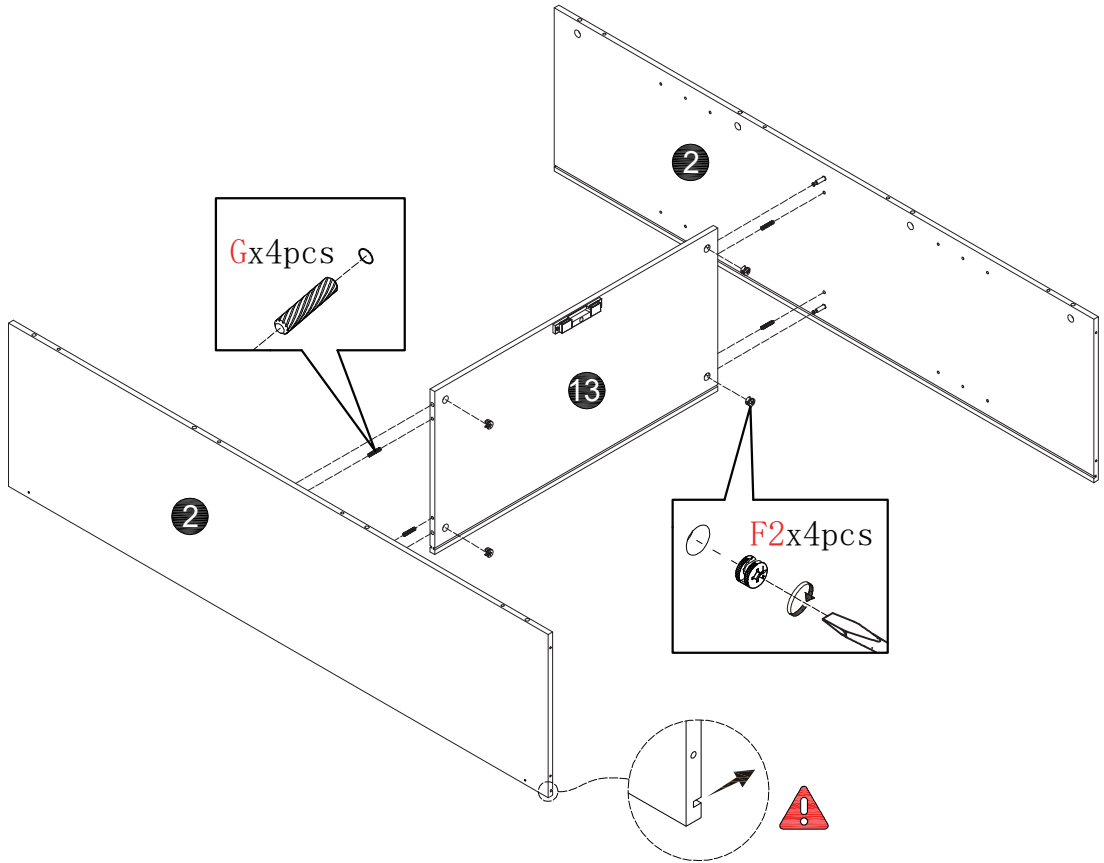
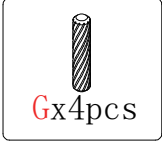

# 4

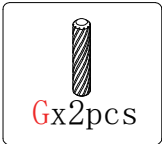

- 3 x1pc
- 4 x1pc
- 5 x1pc

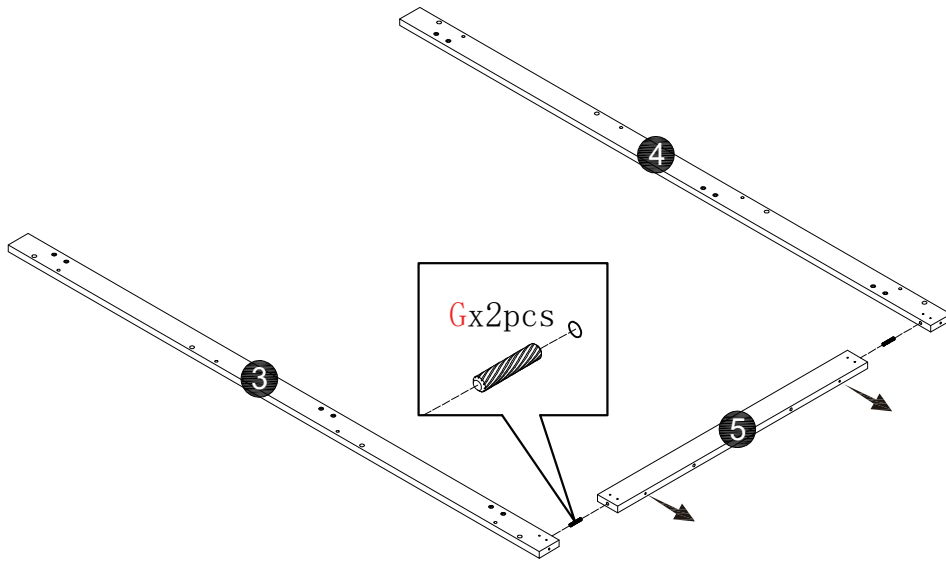

# 5

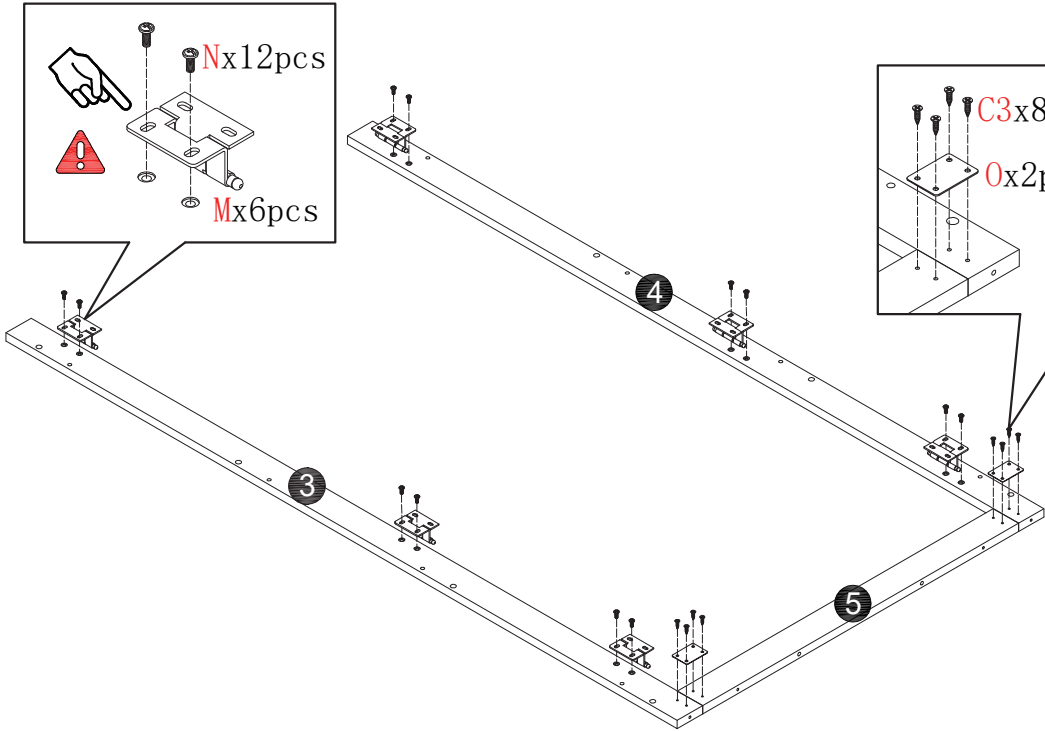
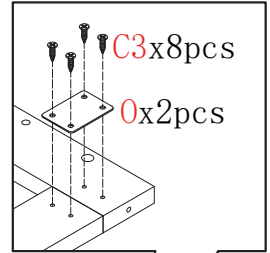
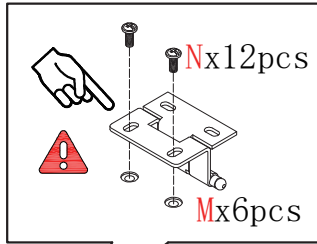
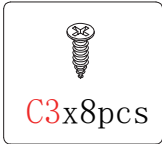
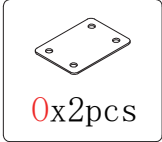

# 6

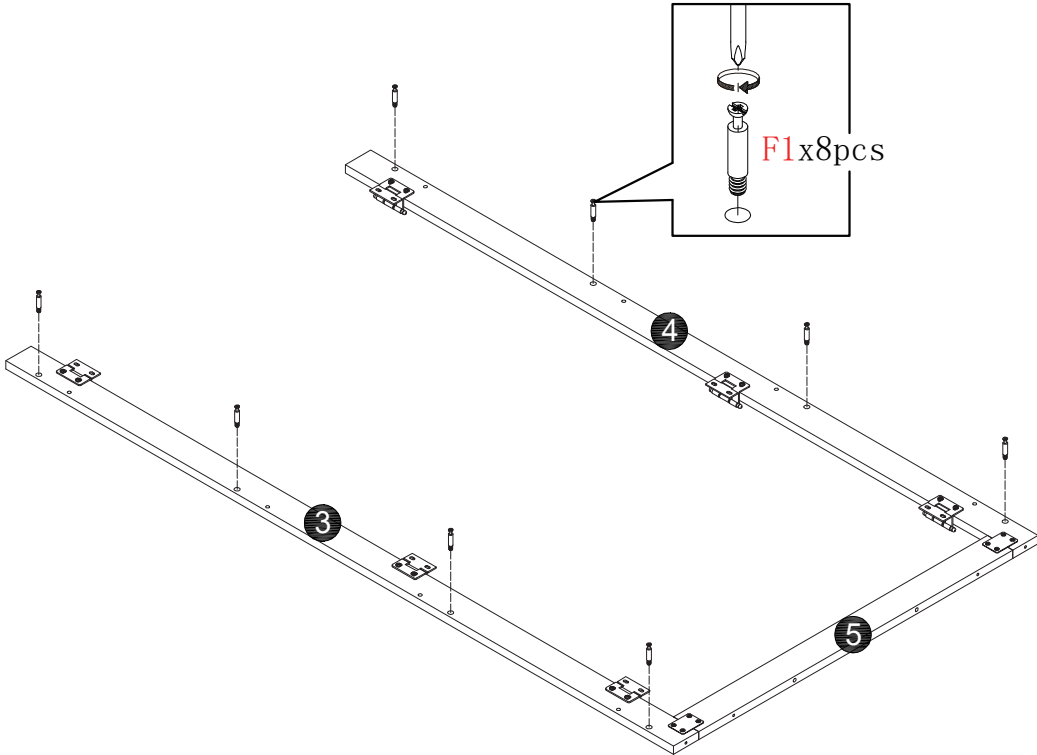
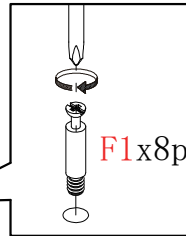
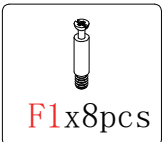

# 7

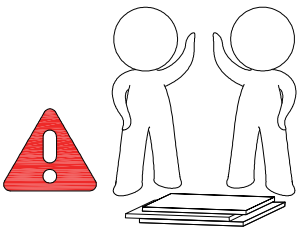
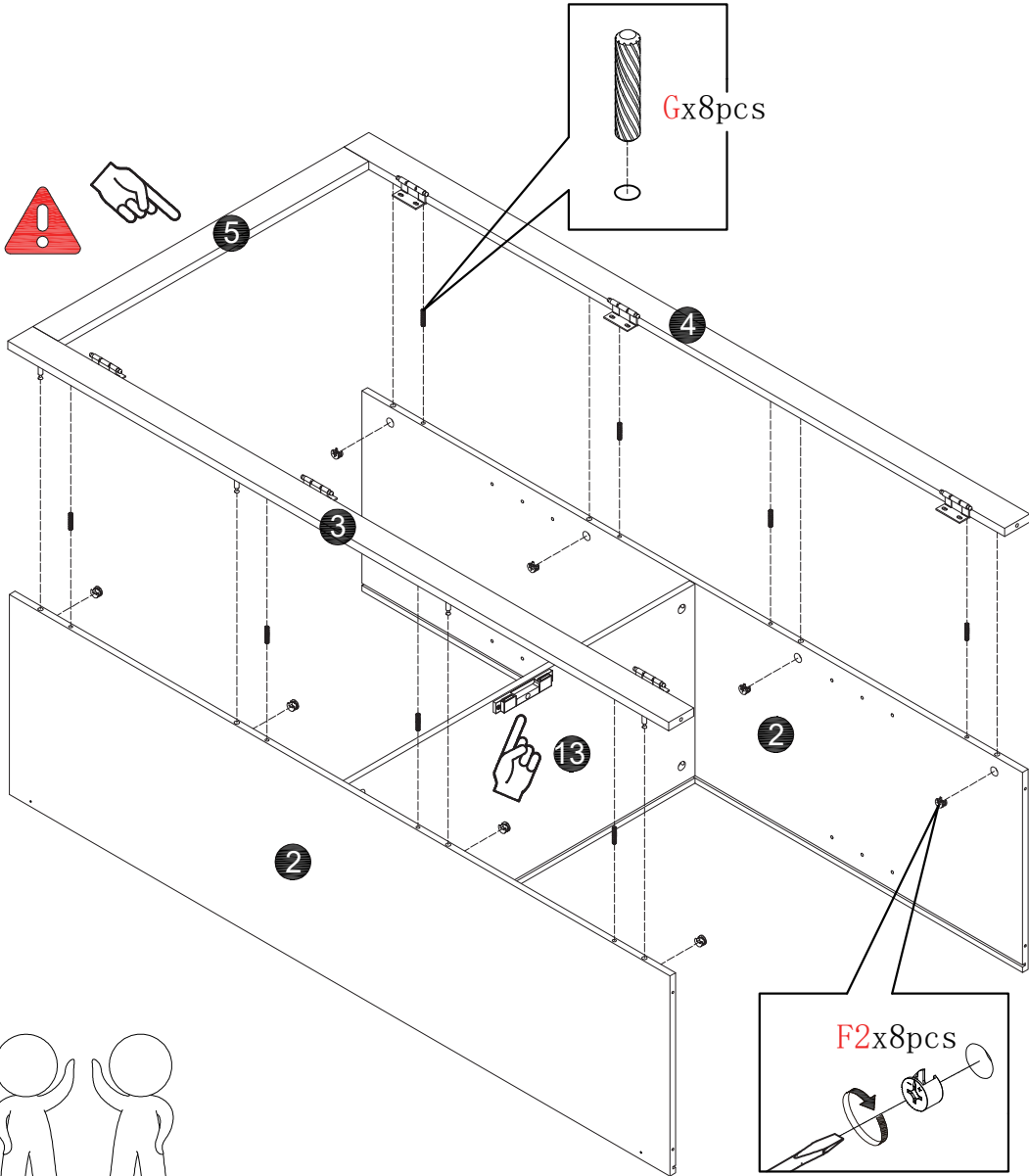
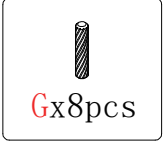
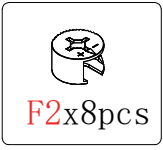

# 8

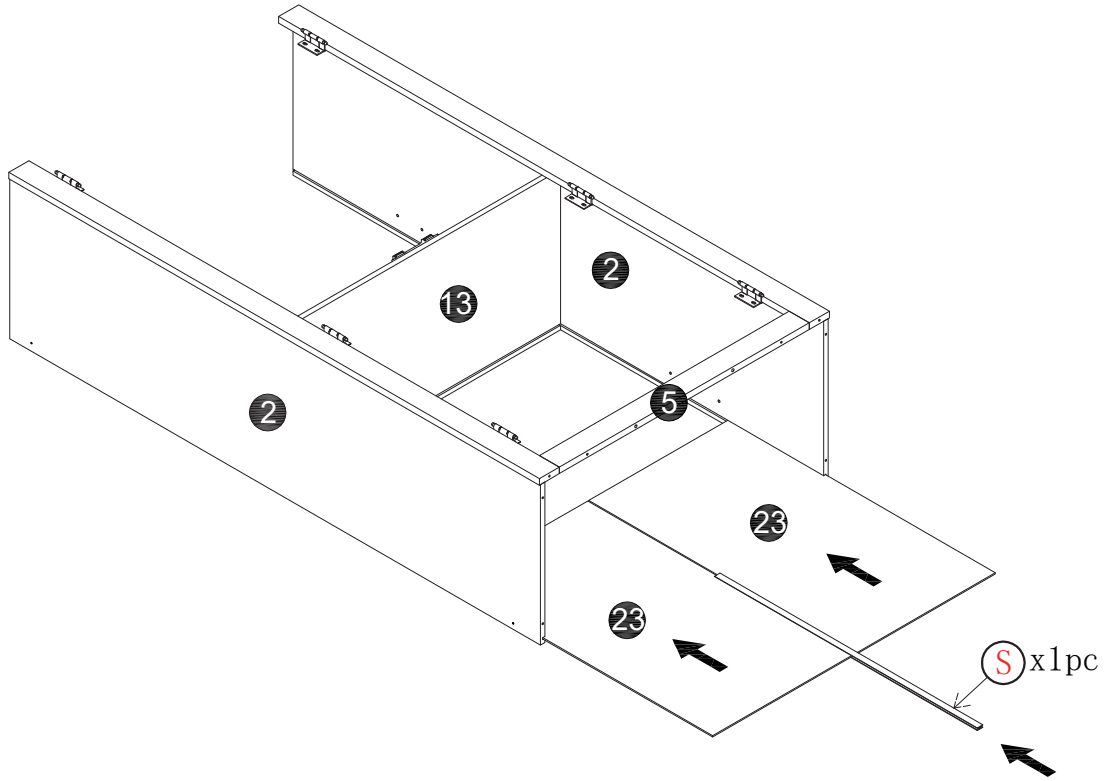
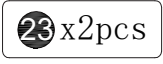
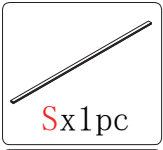

# 9

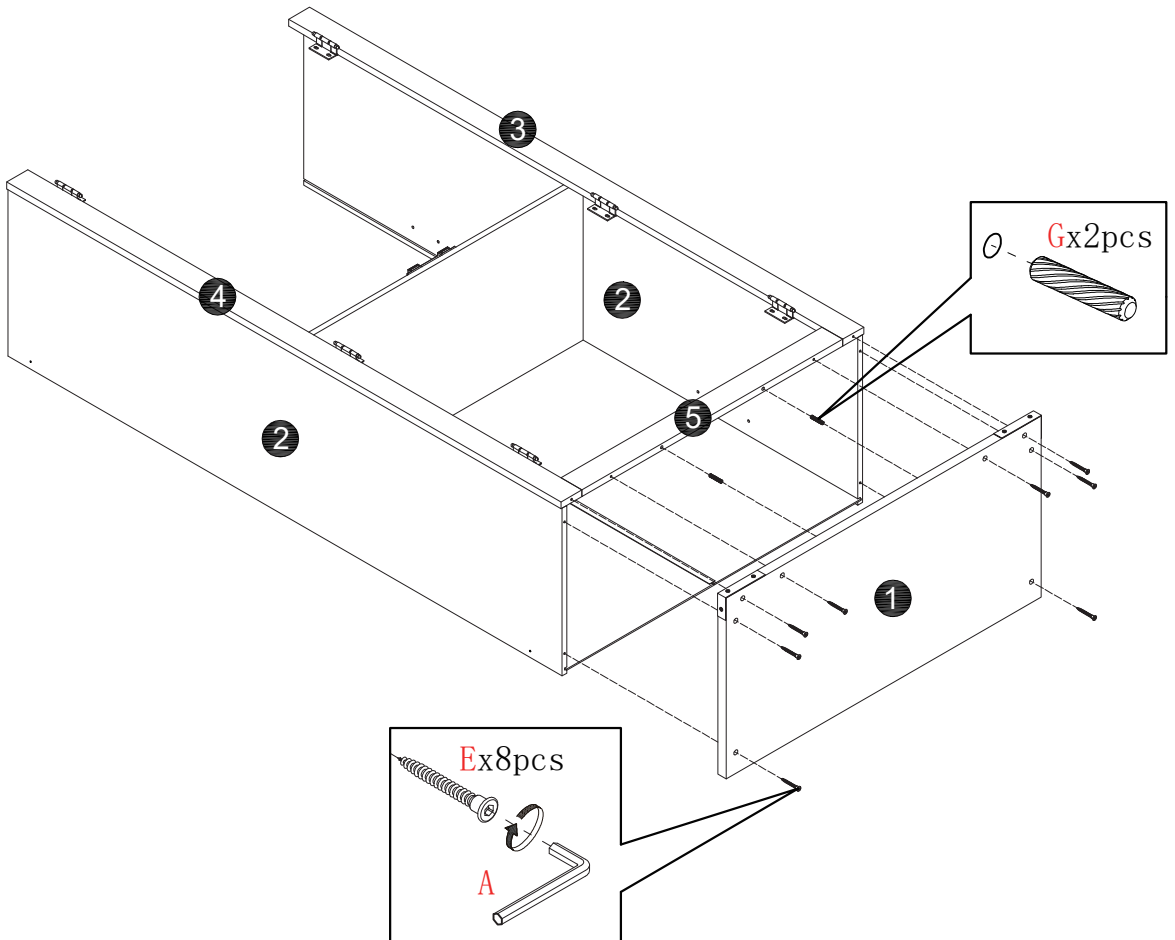
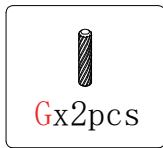

# 10

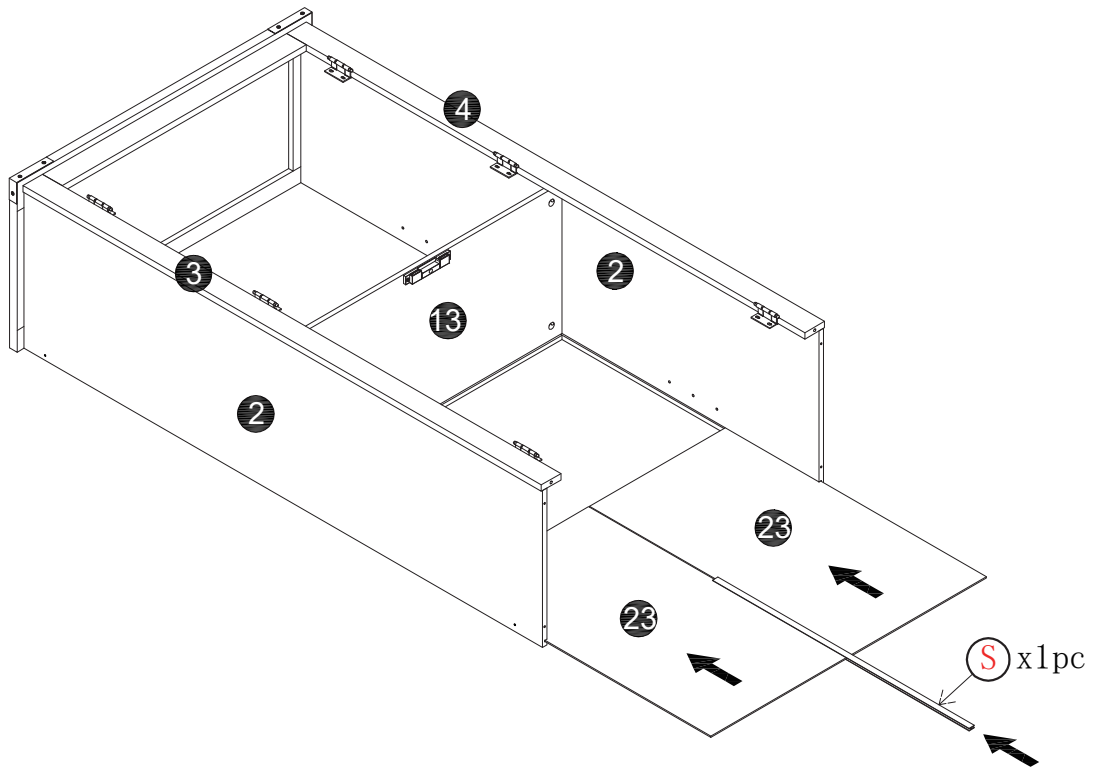
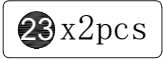
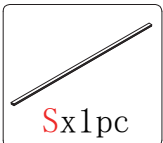

# 11

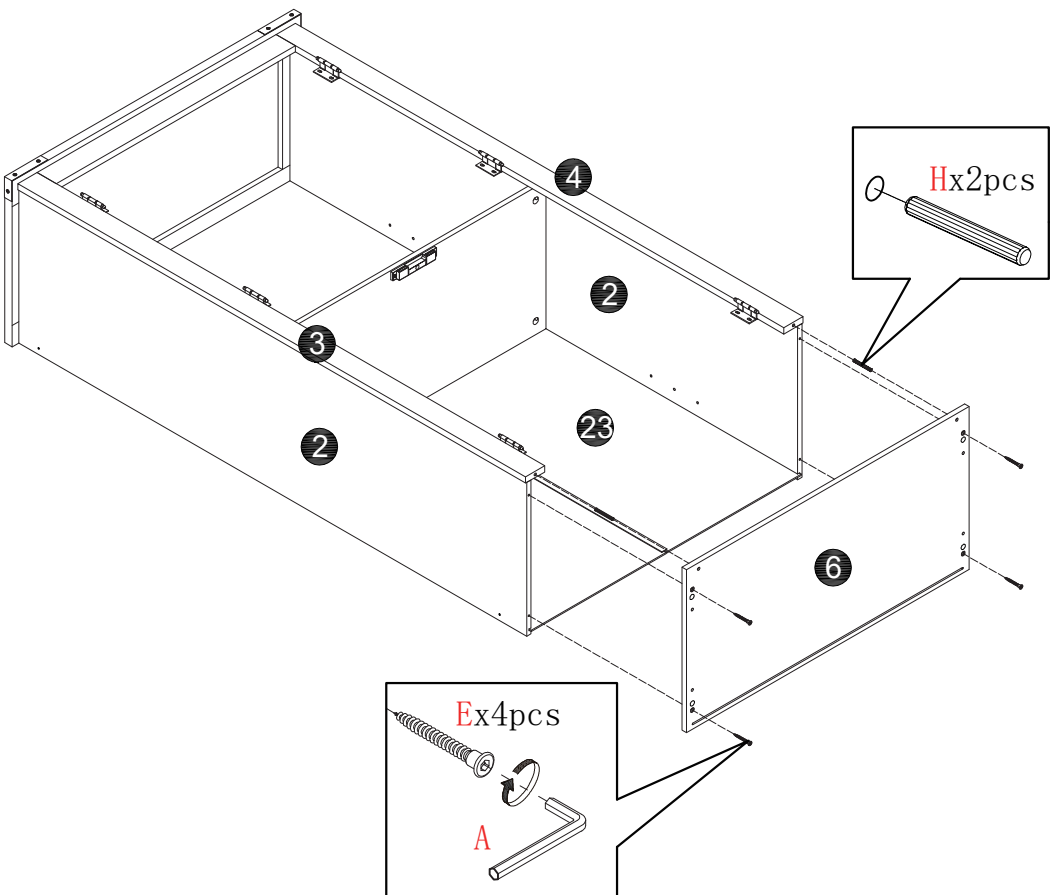
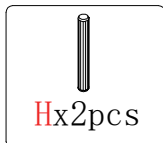
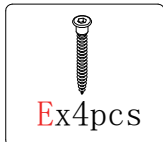

# 12



F1 x4pcs

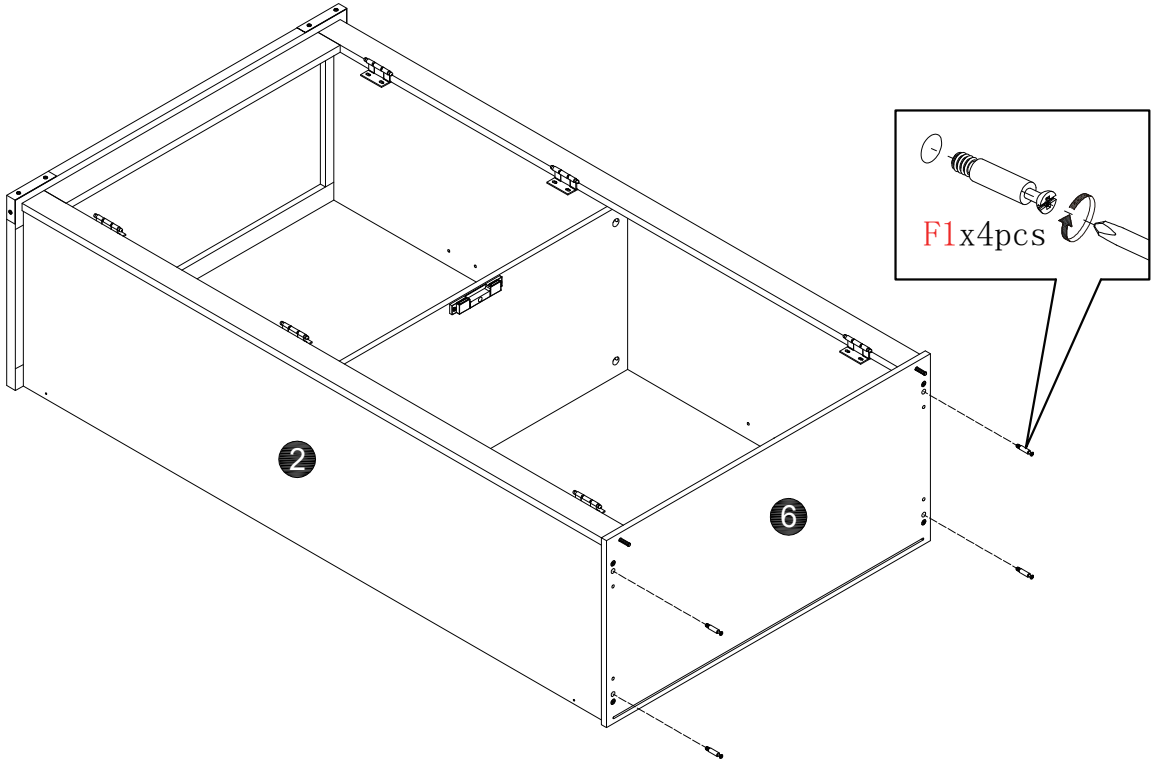

# 13

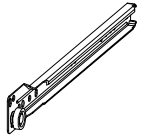

R1 (CL) x1pc

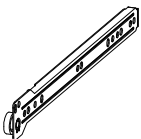

R2 (CR) x1pc



C3 x6pcs







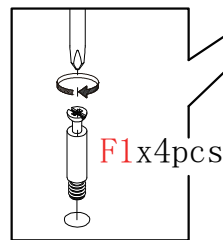
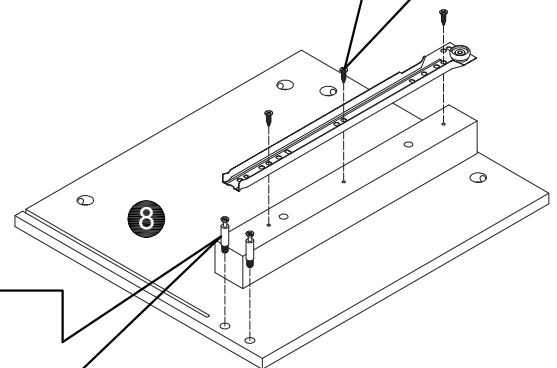
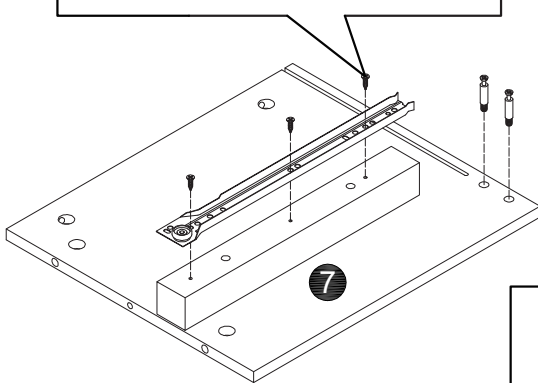
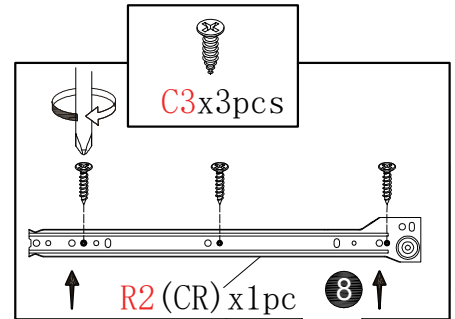
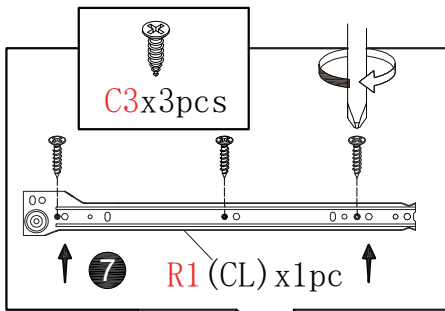

F1 x4pcs

7 x1pc

8 x1pc



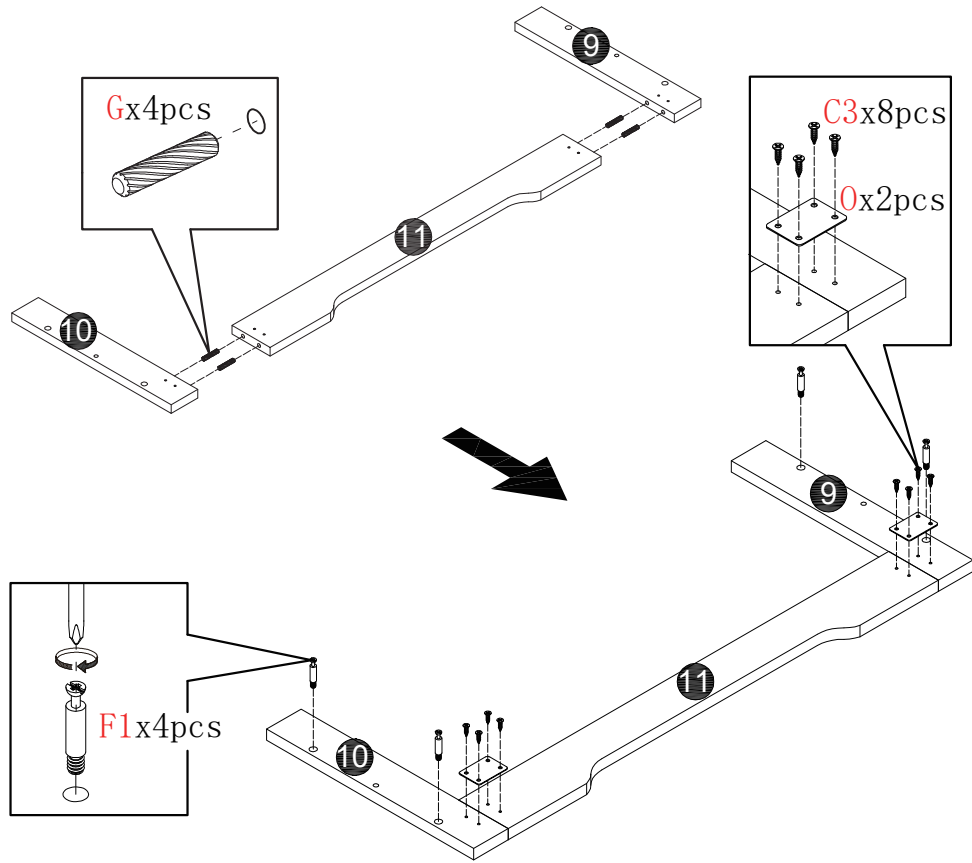

# 14

-  Gx4pcs
-  F1x4pcs
-  Ox2pcs
-  C3x8pcs
-  9 x1pc
-  10 x1pc
-  11 x1pc



# 15

-  F2x4pcs
-  12 x1pc

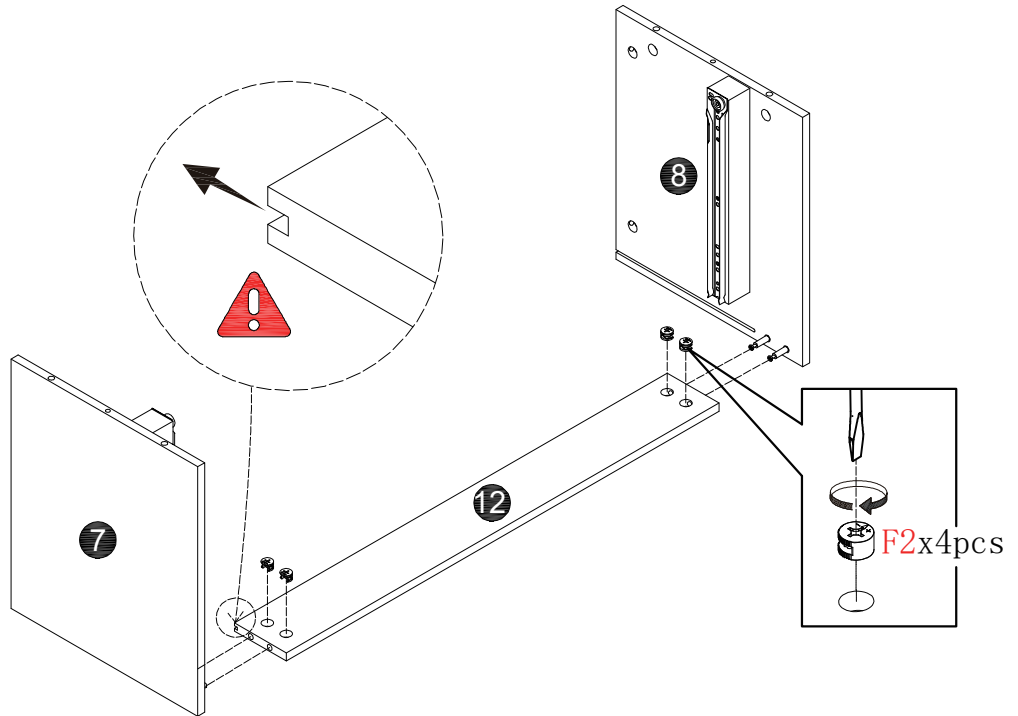

# 16

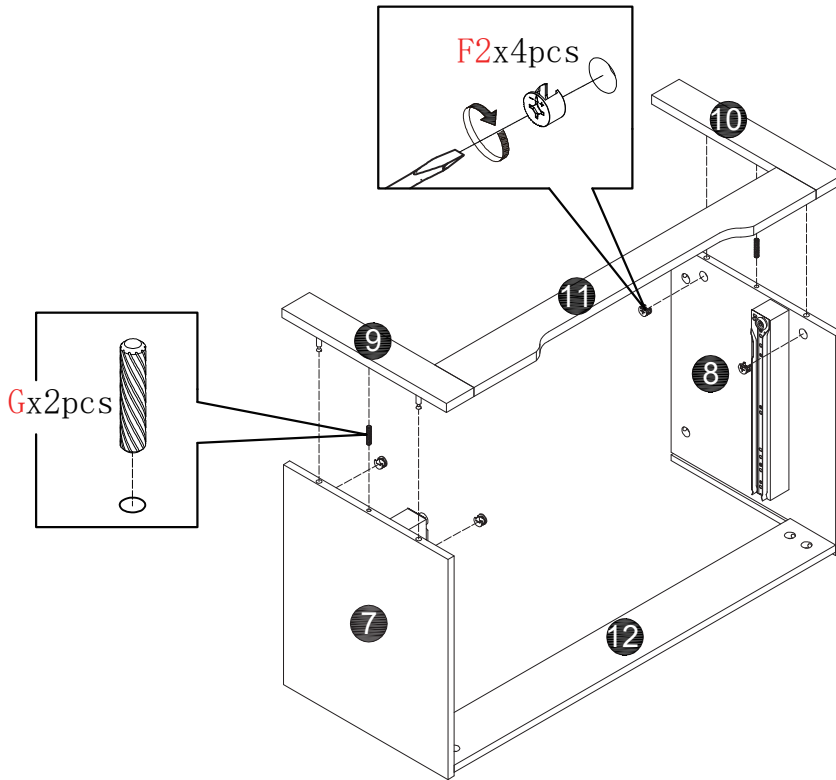
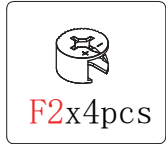
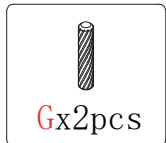

# 17

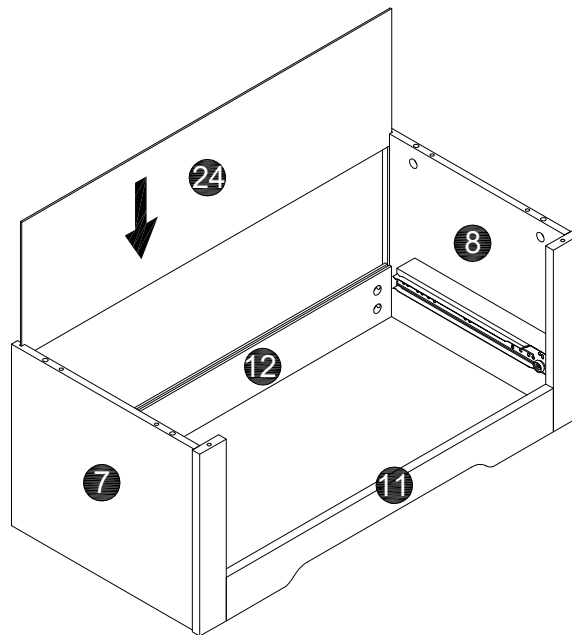

# 18



Gx4pcs



F2x4pcs



Px9pcs

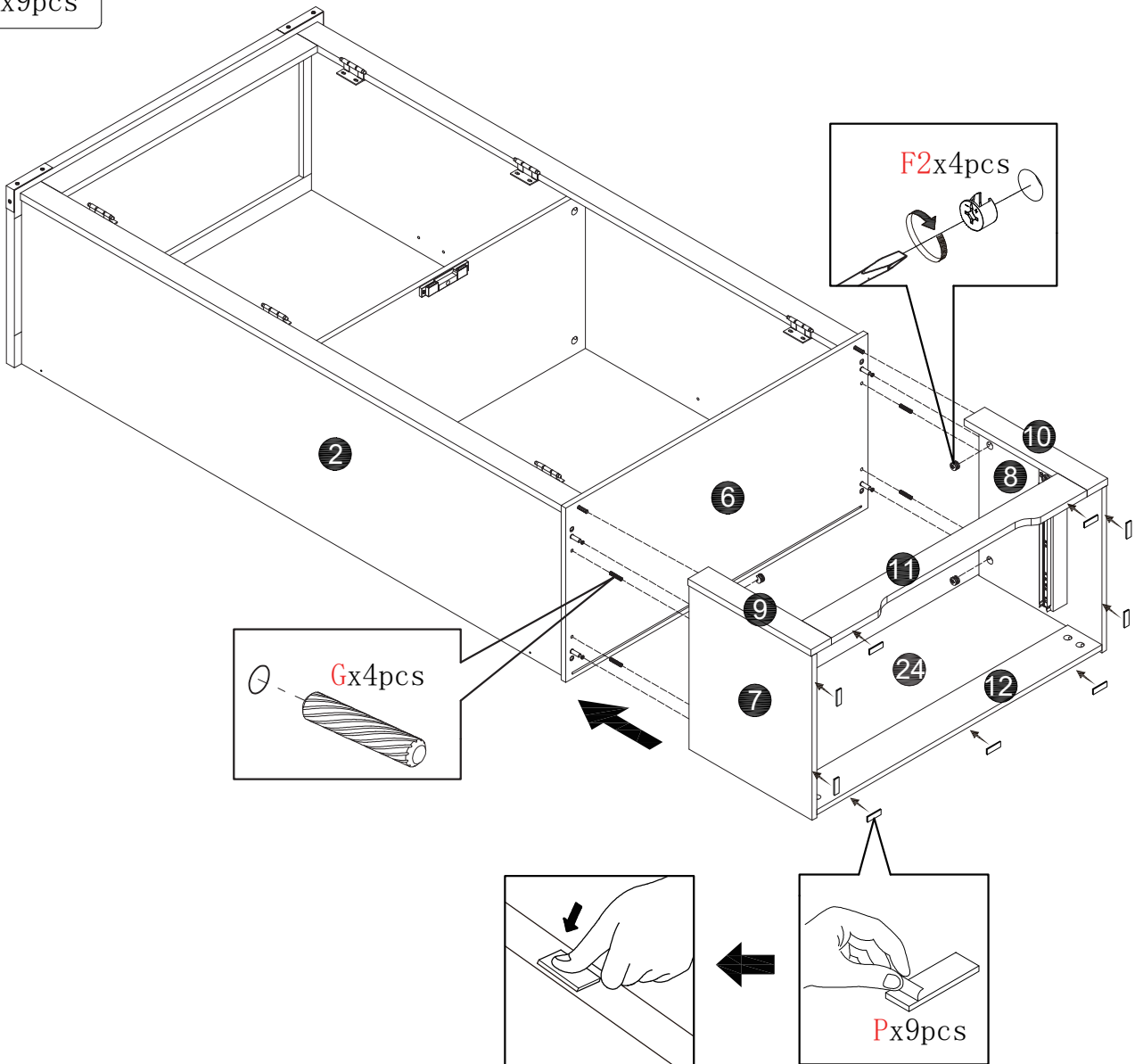

# 19





Jx22pcs

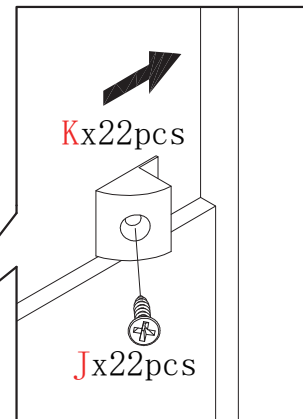
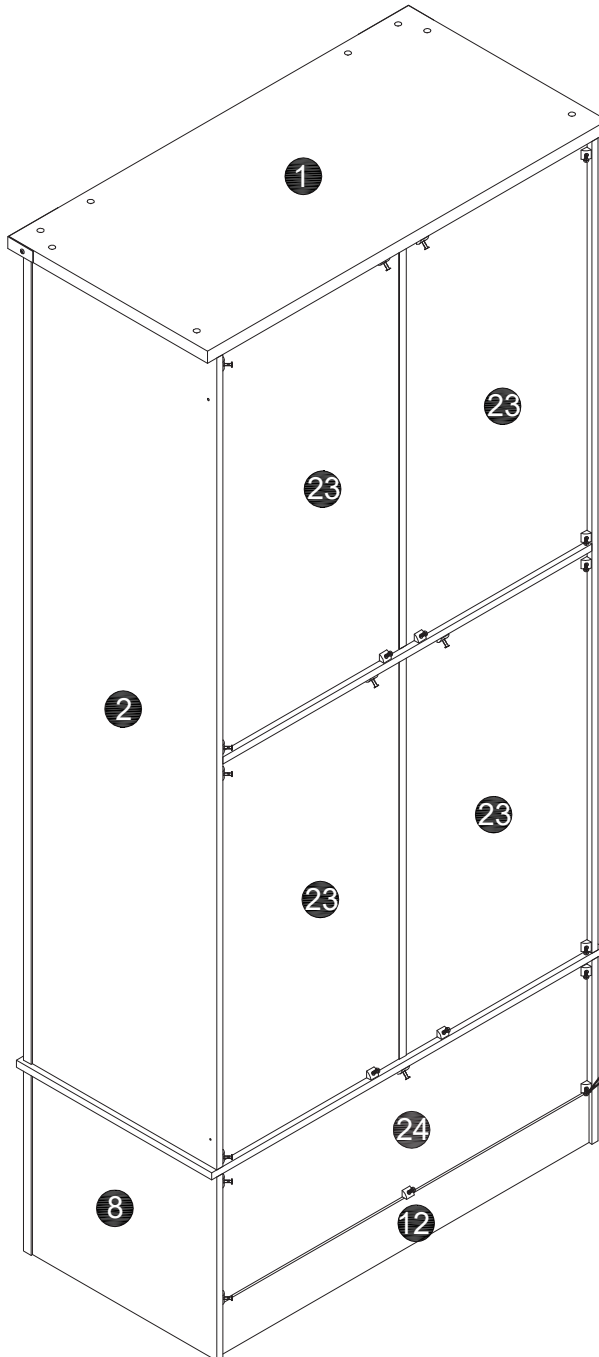

Kx22pcs



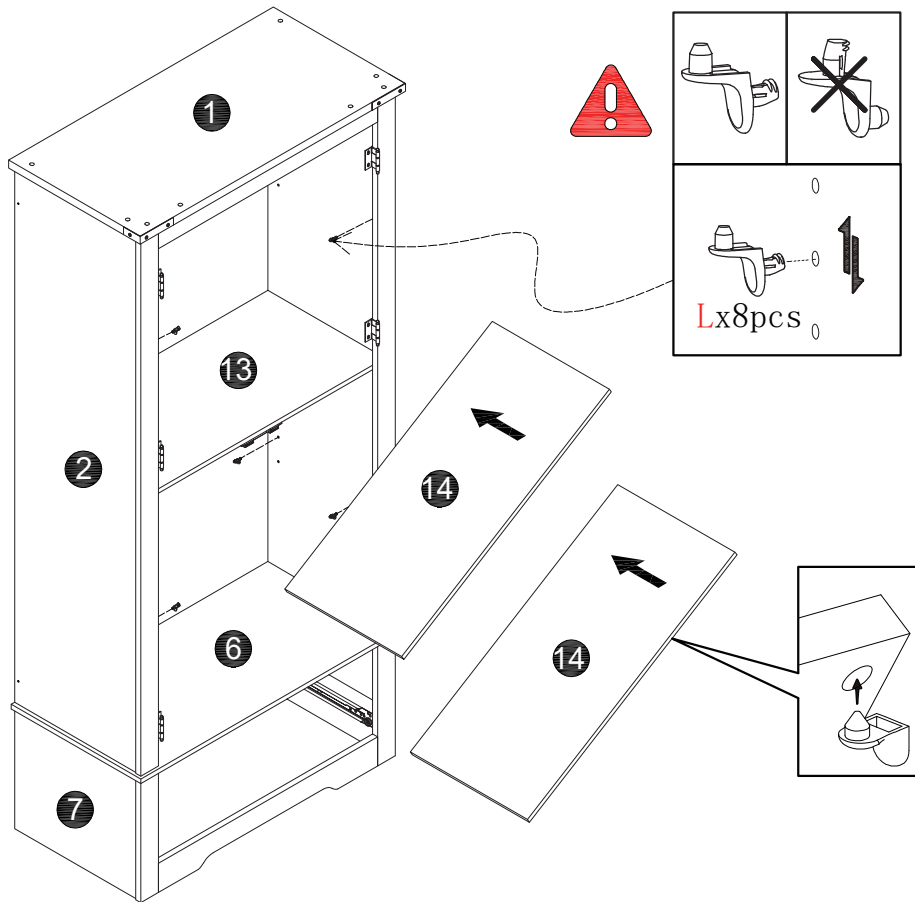

# 20

-  Lx8pcs
-  14 x2pcs



# 21

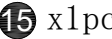
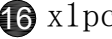

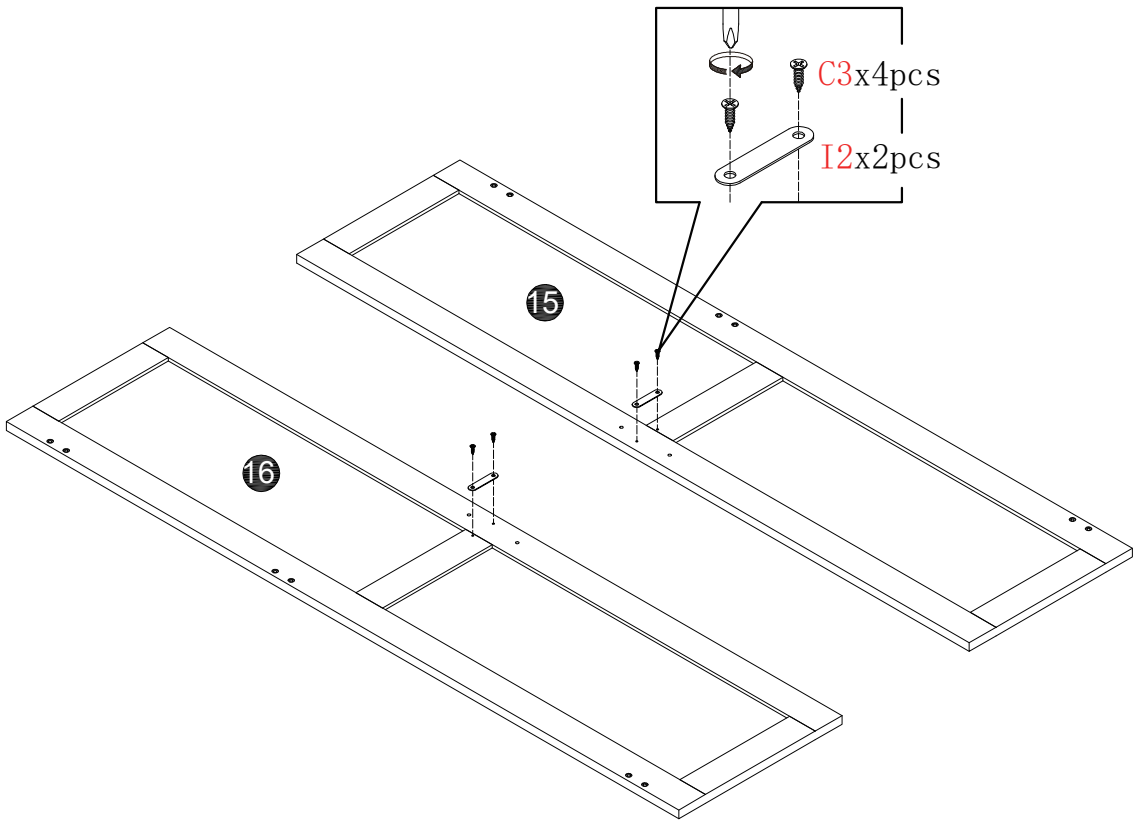

-  C3x4pcs
-  I2x2pcs
-  15 x1pc
-  16 x1pc

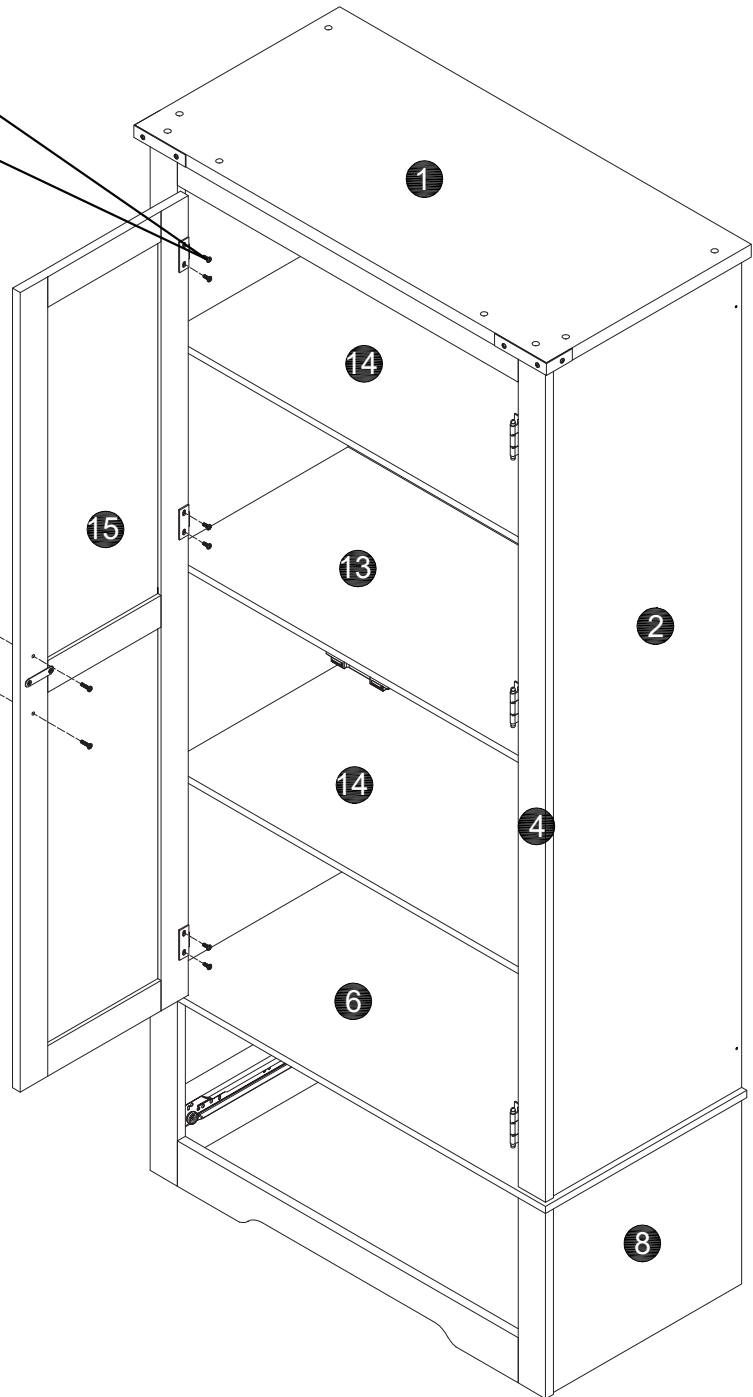
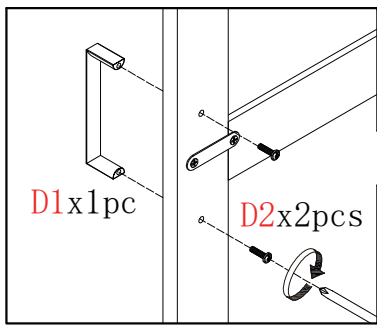
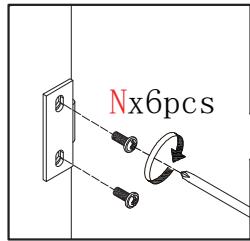
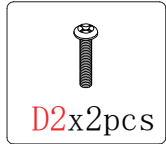
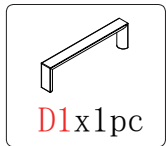

# 22



# 23

-   
D1x1pc
-   
D2x2pcs
-   
Nx6pcs
-   
16x1pc

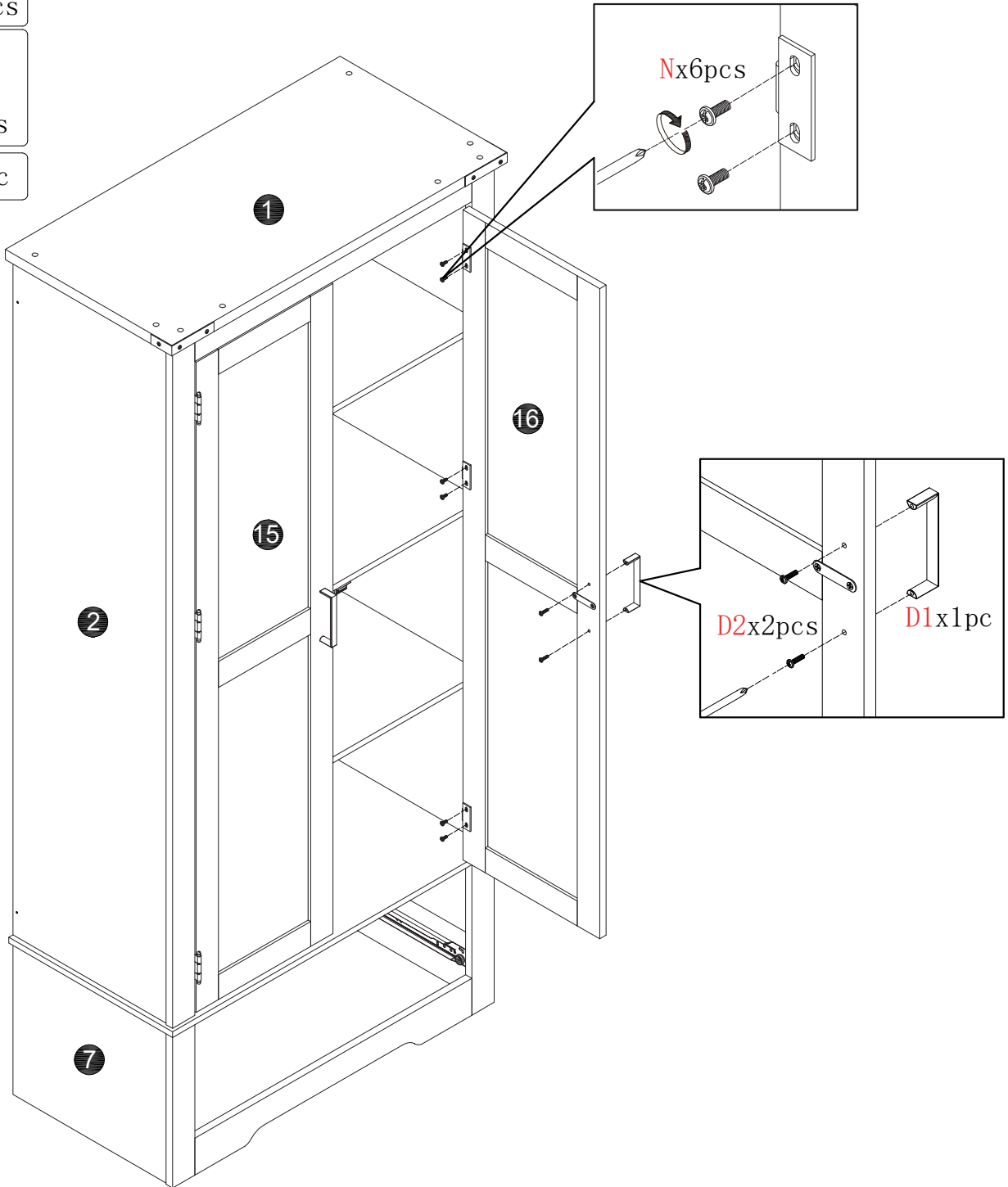

# 24



Qx5pcs

18 x1pc

19 x1pc

20 x1pc

21 x1pc

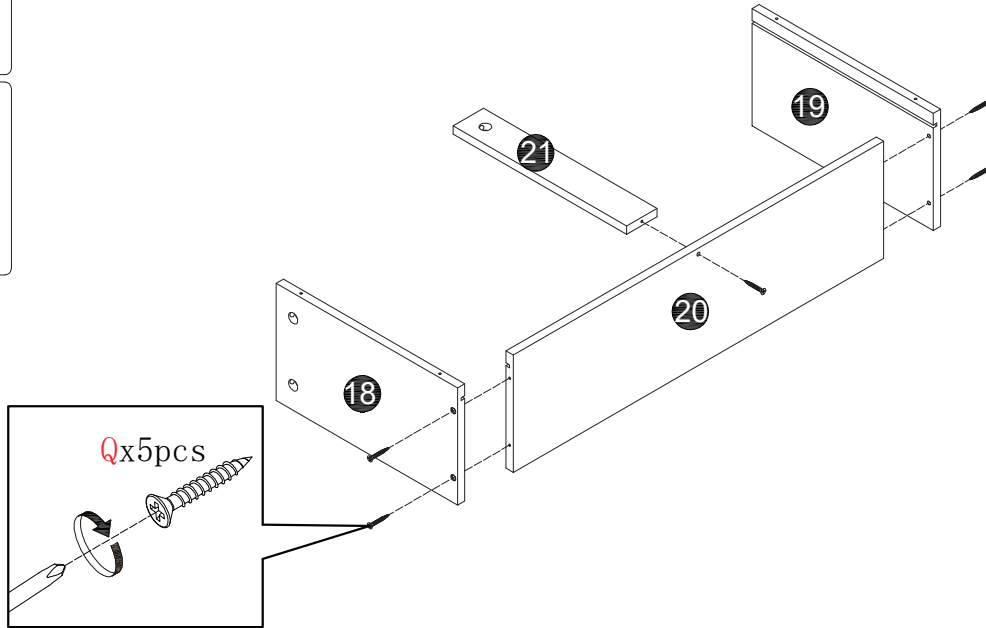

# 25

22 x1pc

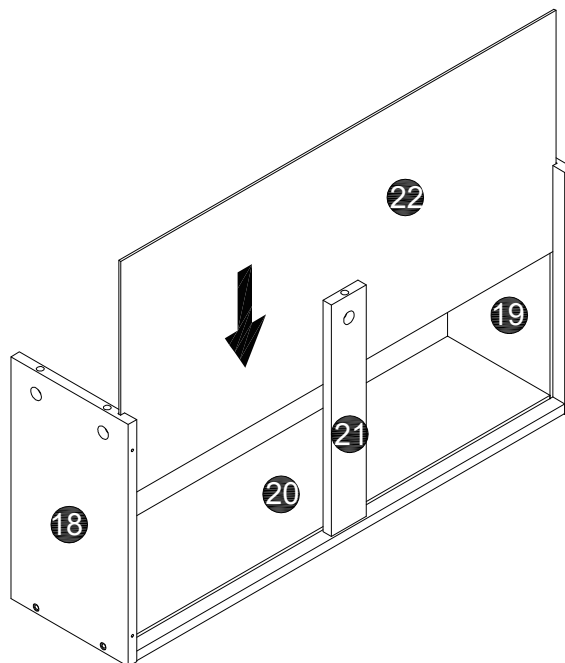

# 26

-  D1x1pc
-  F1x5pcs
-  F2x5pcs
-  Nx2pcs
-  17x1pc

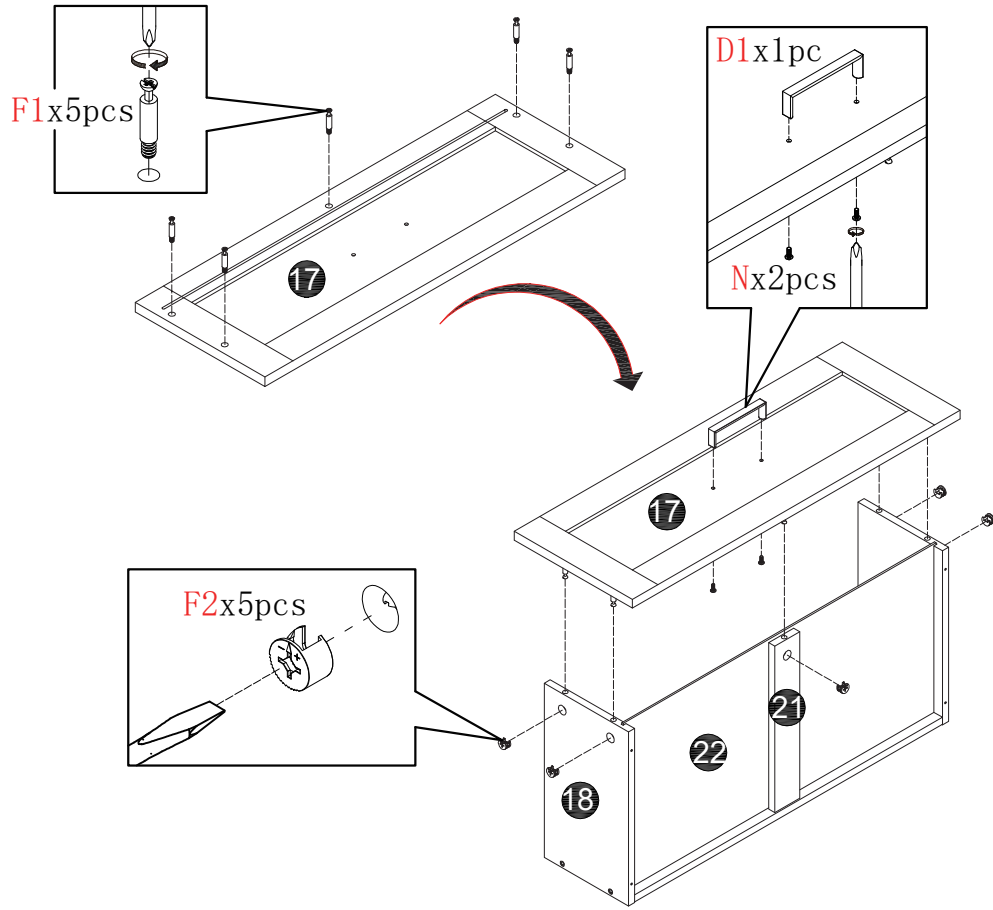

# 27

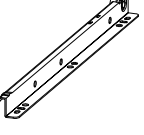
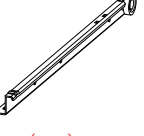
-  C3x4pcs
-  R1 (DL) x1pc
-  R2 (DR) x1pc

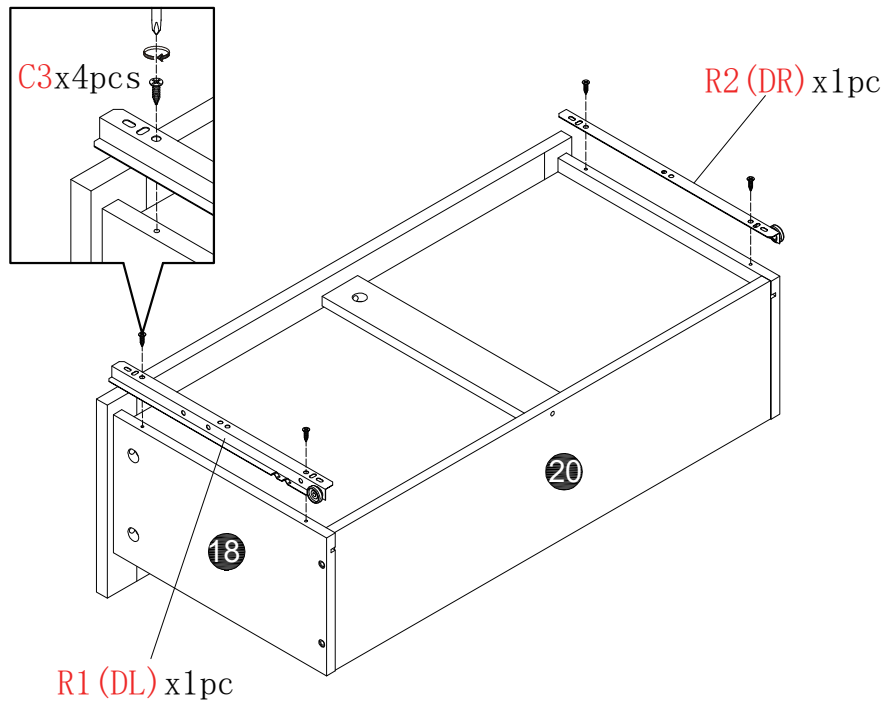

28

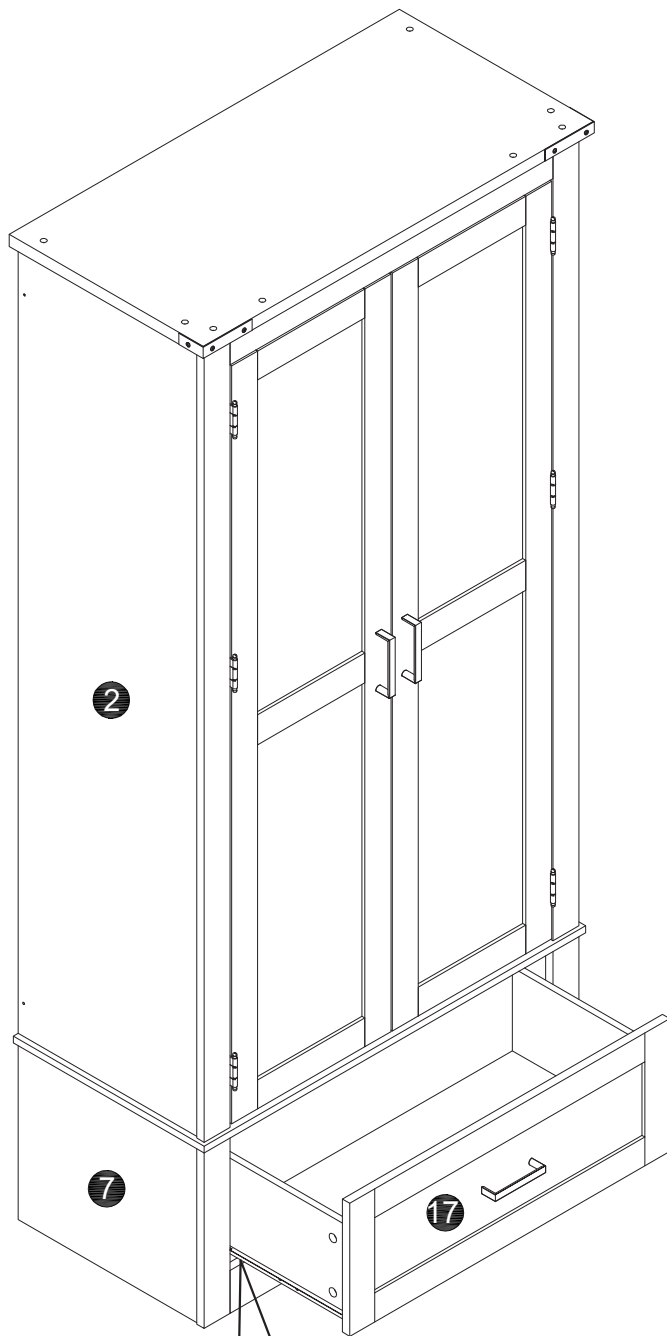

# 29

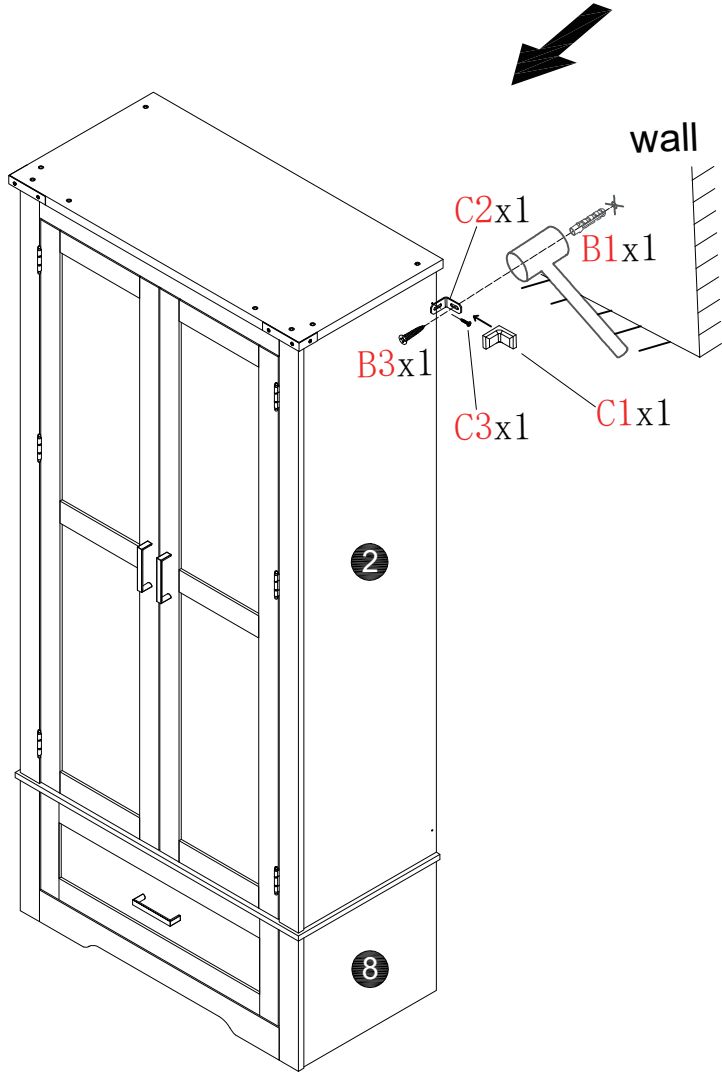
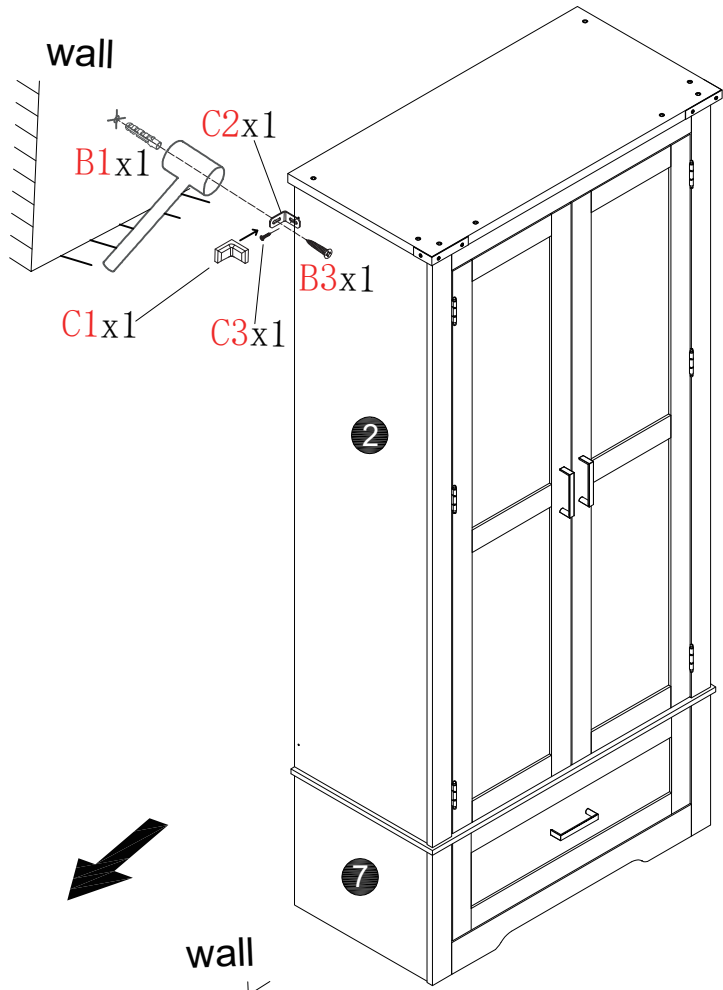
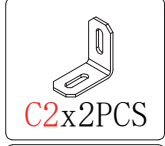
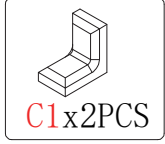
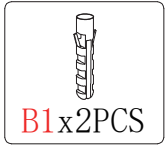

# 30

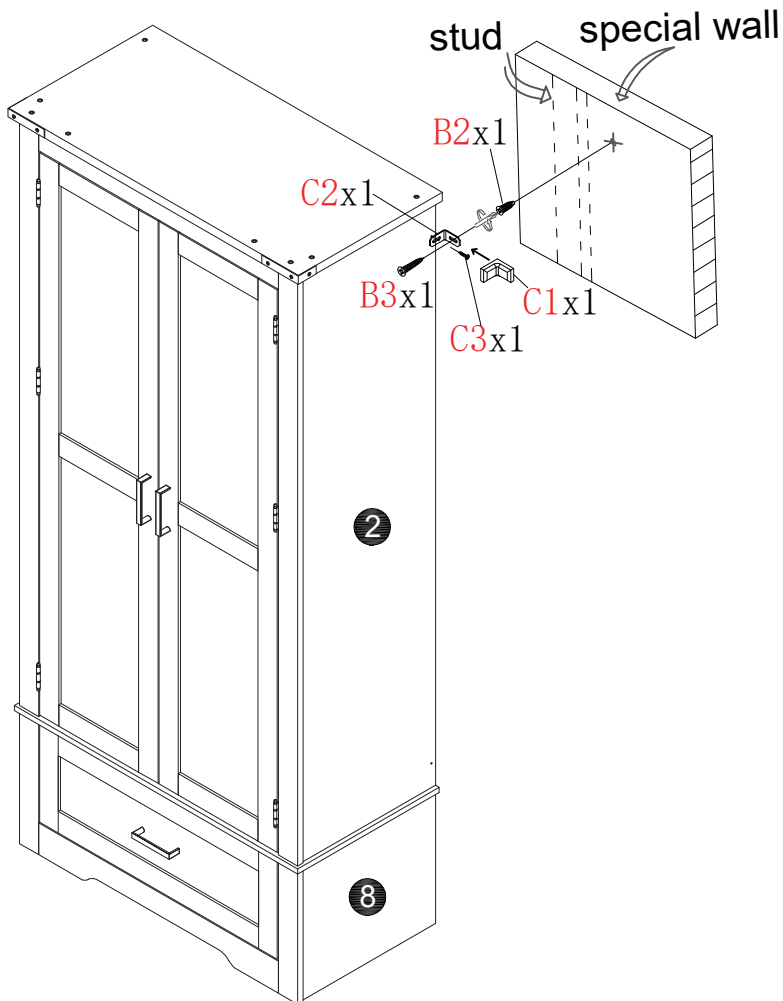
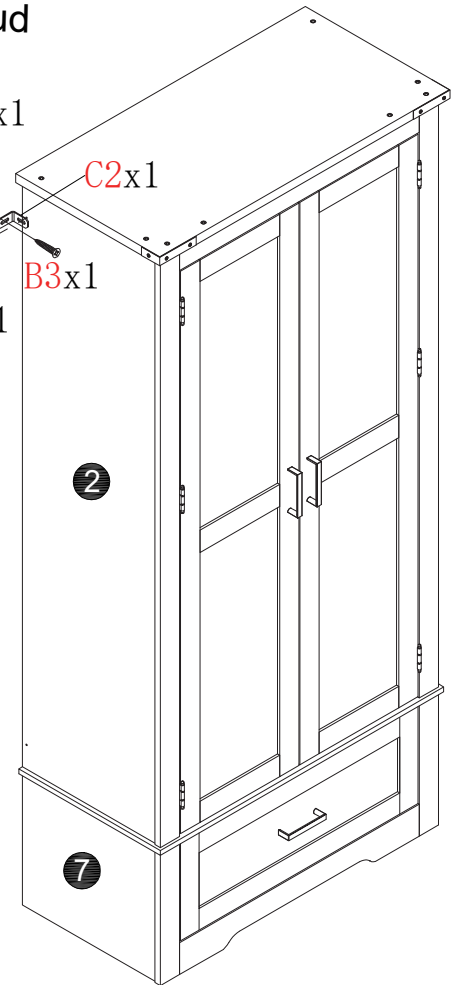
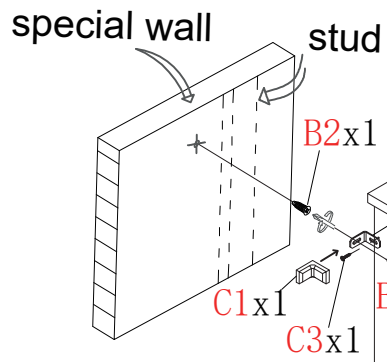
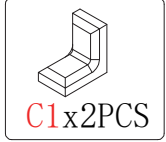
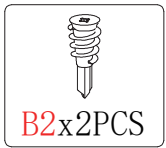

If you have any questions, please contact our customer care center, Our contact details are below:

**US**

 001-877-644-9366

 customerservice@aosom.com

Imported by Aosom LLC  
7777 Center Ave. Suite 430  
Huntington Beach, CA 92647-9998 USA  
MADE IN CHINA

Si tiene alguna pregunta, comuníquese con nuestro Centro de Atención al Cliente, Nuestros datos de contacto son los siguientes:

**ES**

 0034-931294512

 atencioncliente@aosom.es

IMPORTADOR/Fabricante/REP:  
SPANISH AOSOM, S.L.  
C/ROC GROS,Nº15.08550, ELS HOSTALETS DE  
BALENYÀ, SPAIN.  
B66295775  
HECHO EN CHINA

Se tiver alguma dúvida, por favor contacte o nosso Centro de Atendimento ao Cliente, Os nossos dados de contacto são os seguintes:

 0034-931294512

 info@aosom.pt.

IMPORTADOR/Fabricante/REP:  
SPANISH AOSOM, S.L.  
C.ROC GROS N.15, 08550. ELS HOSTALETS DE  
BALENYÀ  
FEITO NA CHINA

If you have any questions, please contact our customer care center, Our contact details are below:

**CA**

 416-792-6088

 customerservice@aosom.ca

Imported by Aosom Canada Inc.  
7270 Woodbine Avenue, Unit 307, Markham,  
Ontario Canada L3R 4B9  
MADE IN CHINA

Si vous avez la moindre question, veuillez contacter notre centre d'assistance à la clientèle, Nos coordonnées sont les suivantes:

 416-792-6088

 customerservice@aosom.ca

Importé par Aosom Canada Inc.  
7270 Woodbine Avenue, unité 307,  
Markham, Ontario Canada L3R 4B9  
FABRIQUÉ EN CHINE

In caso di dubbio, si prega di contattare il nostro centro assistenza clienti, I nostri dettagli di contatto sono di seguito:

**IT**

 0039-0249471447

 clienti@aosom.it

IMPORTATO DA/Produttore/REP:  
AOSOM Italy srl  
Centro Direzionale Milanofiori  
Strada 1 Palazzo F1  
20057 Assago (MI)  
P.I.: 08567220960  
FATTO IN CINA

If you have any questions, please contact our customer care center, Our contact details are below:

**UK**

 0044-800-240-4004

 enquiries@mhstar.co.uk

IMPORTER ADDRESS:  
MH STAR UK Ltd  
1 Northampton Cross Logistics Park  
Northampton Cross Road  
Northampton  
NN4 9FH  
MADE IN CHINA

Wenn Sie Fragen haben, wenden Sie sich bitte an unser Kundendienstzentrum, Unsere Kontaktdaten stehen unten:

**DE**

 0049-0(40)-87408465

 service@aosom.de

ADRESSE DES IMPORTEURE/Hersteller/REP:  
MH Handel GmbH  
Wendenstraße 309  
D-20537 Hamburg  
Germany  
IN CHINA HERGESTELLT

Si vous avez la moindre question, veuillez contacter notre centre d'assistance à la clientèle, Nos coordonnées sont les suivantes:

**FR**

 0033-1-84166106

 aosom@mhfrance.fr

Importé par/Fabricant/REP:  
MH FRANCE  
2 Rue Maurice Hartmann  
92130 Issy Les Moulineaux  
France  
FABRIQUÉ EN CHINE



**FR**

**DONNEZ  
OU  
RECYCLEZ**



ASSOCIATION

OU



LIVRAISON

OU



DÉCHÈTERIE

Adresses sur [quefairedemesdechets.fr](http://quefairedemesdechets.fr)