



FR
**DONNEZ
OU
RECYCLEZ**



ASSOCIATION



LIVRAISON



DÉCHÈTERIE

Adresses sur quefairedemesdechets.fr

Aosom

HOMCOM

IN240300241V03_UK_FR_ES_PT_DE_IT

A70-061V01

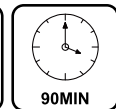
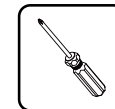

EN_ IMPORTANT, RETAIN FOR FUTURE REFERENCE: READ CAREFULLY.

FR_ IMPORTANT : A LIRE ATTENTIVEMENT ET À CONSERVER POUR CONSULTATION ULTÉRIEURE.

ES_ IMPORTANTE, LEA DETENIDAMENTE Y GUARDE PARA FUTURAS REFERENCIAS.

PT_ IMPORTANTE, GUARDE PARA FUTURA REFERÊNCIA, LEIA ATENTAMENTE.

DE_ „WICHTIG! SORGFÄLTIG LESEN UND FÜR SPÄTER NACHSCHLAGEN AUFBEWAHREN.“

IT_ IMPORTANTE, LEGGERE E CONSERVARE QUESTO MANUALE D'ISTRUZIONE PER UN USO FUTURO.

 **WARNING:**

CHOKING HAZARD-Small parts.

Not for children under 3 years.

CAUTIONS: Must assure the product is correctly assembled according to the instruction before use. (Assembly tools are included in the box)

The process of assembly must be done by an adult or under direction of an adult.

 **Advertencia:**

PELIGRO DE ASFIXIA - Piezas pequeñas.

No apto para niños menores de 3 años.

PRECAUCIONES: Debe asegurarse de que el producto está correctamente montado según las instrucciones antes de su uso. (Las herramientas de montaje se incluyen en la caja)

El proceso de montaje debe ser realizado por un adulto o bajo la supervisión de un adulto.

 **AVERTISSEMENT:**

Risque d'étouffement. Petites pièces.

Attention. Ne convient pas aux enfants de moins de 36 mois.

ATTENTION : Assurez-vous que le produit soit correctement assemblé selon les instructions avant l'utilisation. (Les outils d'assemblage sont dans la boîte). L'assemblage du produit doit être fait par un adulte ou sous la supervision d'un adulte.

 **AVVERTIMENTO:**

PERICOLO DI SOFFOCAMENTO a causa di piccole parti.

Non per bambini sotto i 3 anni.

ATTENZIONE: Assicurarsi che il prodotto sia correttamente assemblato in accordo con le istruzioni prima dell'uso (gli strumenti per l'assemblaggio sono inclusi nella scatola).

Il processo d'assemblaggio dev'essere seguito da un adulto o sotto la supervisione di un adulto.

 **WARNUNG:**

Erstickengefahr - Kleinteile.

Nicht für Kinder unter 3 Jahren.







































VORSICHT: Stellen Sie bitte vor dem Gebrauch sicher, dass das Produkt nach der Aufbauanleitung richtig montiert ist. (Die Montagewerkzeuge sind im Lieferumfang enthalten.) Erwachsene Montage erforderlich.

 **ATENÇÃO**

Risco de Asfixia.

Este brinquedo contém pequenas, não é adequado para crianças menores de 3 anos.

Atenção: Certifique que o brinquedo foi montado corretamente segundo o manual de instruções antes de utilizar. As ferramentas de montagem estão incluídas na caixa. O processo de montagem somente deve ser realizado por um adulto.

1	1X		19	+1 (spare) 4X	 4*10mm	37	4X	
2	1X		22	+2 (spare) 22X	 3*20mm	42	2X	
3	1X		23	1X		43	2X	
4	1X		24	4X		44	1X	
5	1X		25	2X		45	1X	
6	2X		26	2X		46	1X	
7	2X		27	8X		47	1X	
8	1X		28	8X		48	2X	
9	2X		29	16X		49	2X	
10	2X		31	2X		50	3X	
15	+1 (spare) 8X	 4*40mm	32	2X		51	1X	
16	+1 (spare) 20X	 8*30mm	34	2X		52	2X	
17	+1 (spare) 4X	 3.5*40mm	35	11X		53	1X	
18	+1 (spare) 8X	 3*11mm	36	11X		54	2X	
						55	4X	

UK

If you have any questions, please contact our customer care centre.

Our contact details are below:

 0044-800-240-4004

 enquiries@mhstar.co.uk

IMPORTER ADDRESS:
MH STAR UK LTD
1 Northampton Cross Logistics Park
Northampton Cross Road
Northampton
NN4 9FH
MADE IN CHINA

FR

Si vous avez la moindre question, veuillez contacter notre centre d'assistance à la clientèle.

Nos coordonnées sont les suivantes:

 0033-1-84166106

 aosom@mhfrance.fr

Importé par/Fabricant/REP:
MH France
2, rue Maurice Hartmann
92130 Issy-les-Moulineaux
France
Fabriqué en Chine

DE

Wenn Sie Fragen haben, wenden Sie sich bitte an unser Kundendienstzentrum.

Unsere Kontaktdaten stehen unten:

 0049-0(40)-87408465

 service@aosom.de

Importeur/Hersteller/REP:
MH Handel GmbH
Wendenstraße 309
D-20537 Hamburg
Germany
IN CHINA HERGESTELLT

ES

Si tiene alguna pregunta, comuníquese con nuestro Centro de Atención al Cliente. Nuestros datos de contacto son los siguientes:

 0034-931294512

 atencioncliente@aosom.es

Importador/Fabricante/REP:
Spanish Aosom, S.L.
C/ Roc Gros, n° 15. 08550, Els Hostalets de Balenyà, Spain.
B66295775
atencioncliente@aosom.es
TEL: 931294512
HECHO EN CHINA

PT

Se tiver alguma dúvida, por favor contacte o nosso Centro de Atendimento ao Cliente. Os nossos dados de contacto são os seguintes:

 0034-931294512

 info@aosom.pt.

IMPORTADOR:
SPANISH AOSOM, S.L.
C.ROC GROS N.15, 08550. ELS HOSTALETS DE BALENYÀ
TEL: 931294512 (SEG-SEX DAS 7:30H ÀS 16:30H)
INFO@AOSOM.PT
WWW.AOSOM.PT

IT

In caso di dubbio, si prega di contattare il nostro centro assistenza clienti. I nostri dettagli di contatto sono di seguito:

 0039-0249471447

 clienti@aosom.it

IMPORTATO DA/Produttore/REP:
AOSOM Italy srl
Centro Direzionale Milanofiori
Strada 1 Palazzo F1
20057 Assago (MI)
P.I.: 08567220960
FATTO IN CINA

07

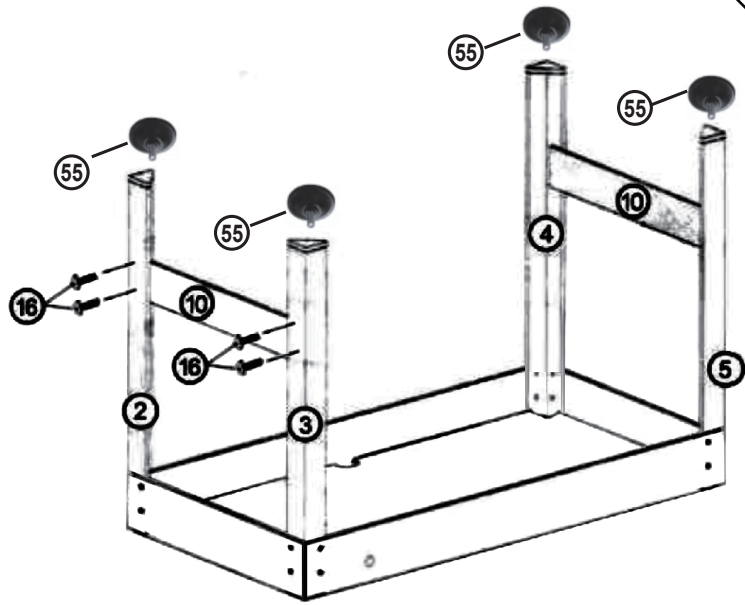
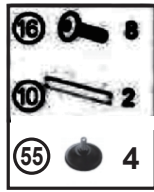

01

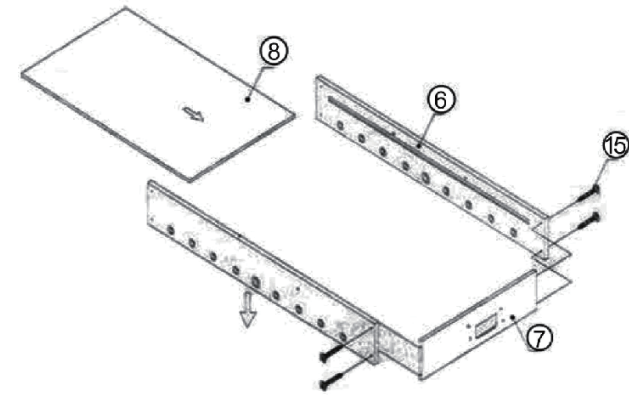

Done

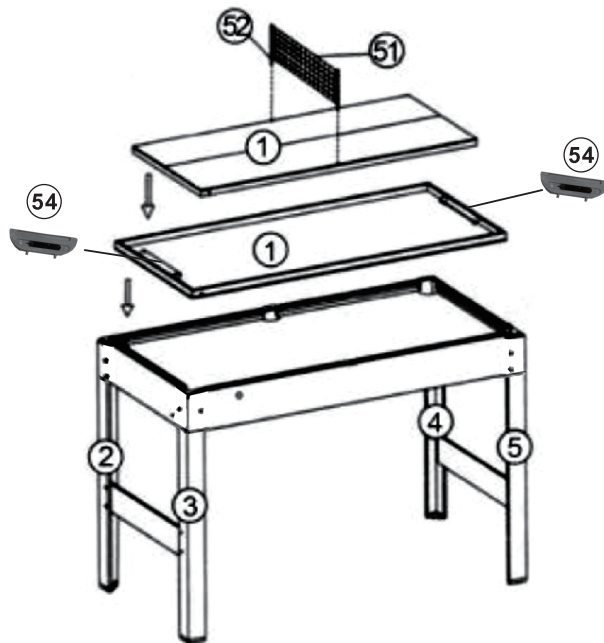

02

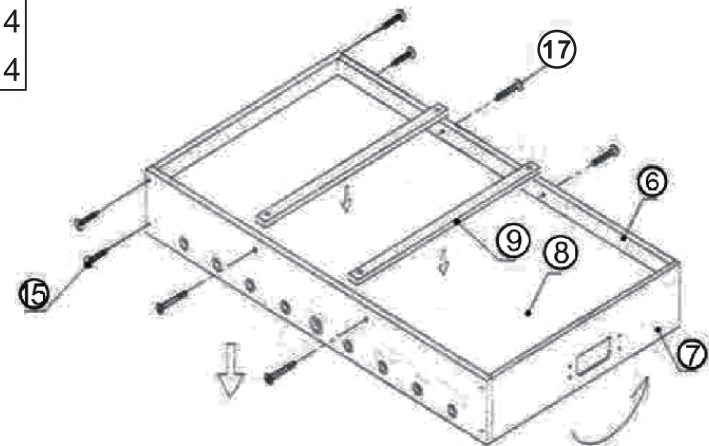
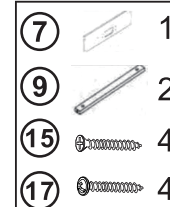

03

- 19 4
- 22 22
- 24 4
- 25 2
- 26 2
- 35 11
- 36 11
- 37 4
- 29 16

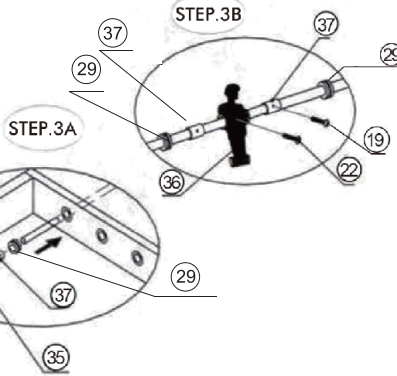
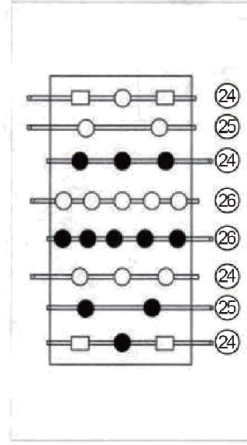
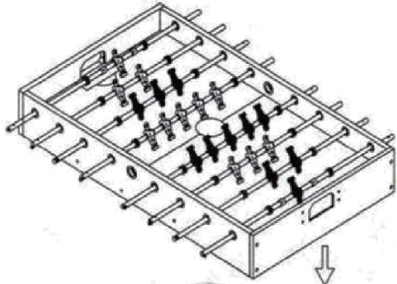

05

- 27 8
- 28 8

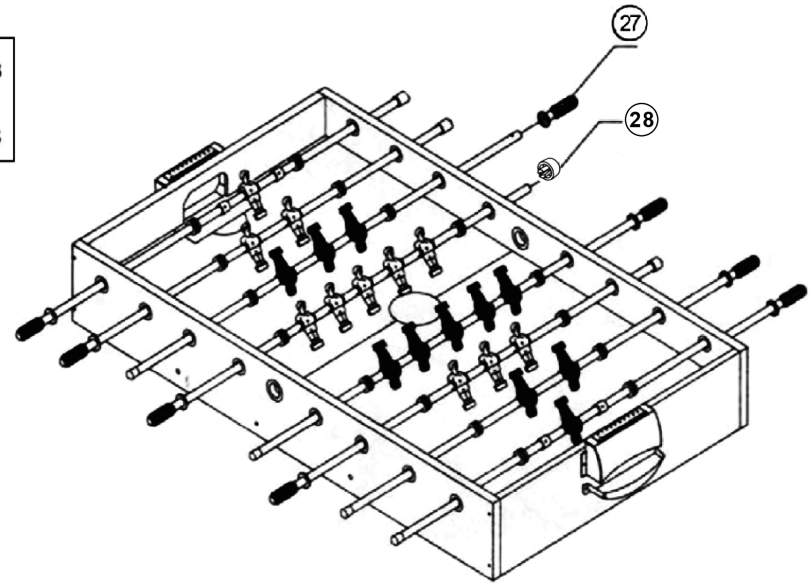

04

- 18 8
- 31 2
- 32 2

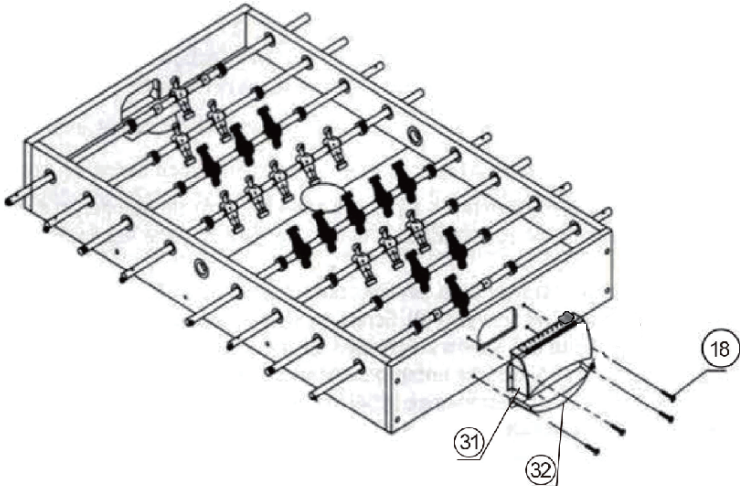

06

- 2 1
- 3 1
- 4 1
- 5 1
- 16 12

