

EN_IMPORTANT, RETAIN FOR FUTURE REFERENCE: READ CAREFULLY.

FR_IMPORTANT: A LIRE ATTENTIVEMENT ET A CONSERVER POUR VOUS Y REFERRER ULTERIEUREMENT

ES_IMPORTANTE, LEA DETENIDAMENTE Y GUARDE PARA FUTURAS REFERENCIAS.

PT_IMPORTANTE, GARDE PARA FUTURA REFERÊNCIA, LEIA ATENTAMENTE.

DE_WICHTIG! SORFGFÄLTIG LESEN UND FÜR SPÄTERES NACHSCHLAGEN AUFBEWAHREN.

IT_IMPORTANTE, LEGGERE E CONSERVARE QUESTO MANUALE D'ISTRUZIONE PER UN USO FUTURO.

RO_IMPORTANT, DE PĂSTRAT PENTRU REFERINȚE VIITOARE: CITIȚI CU ATENȚIE.

IMPORTANT, RETAIN FOR FUTURE REFERENCE: READ CAREFULLY.

Only for domestic use

1. Safety Warnings & Precautions

- Do not place the furniture in areas exposed to high heat, humidity, or direct sunlight.
- Avoid placing heavy objects on the surface to prevent structural deformation or damage.
- Ensure the floor is dry to reduce slip risks.

2. Assembly Guide

- Open packaging and verify all parts are included.
- Tighten feet periodically to prevent loosening.

3. Usage Instructions

- Distribute weight evenly to avoid overloading one side.

4. Maintenance & Care

- Wooden Surfaces: Clean with dry cloths only; avoid moisture.
- Glass/Ceramic Tops: Use neutral cleaners; never apply acidic or abrasive agents.
- Store in a dry, ventilated area after cleaning; avoid humid environments.

The manufacturer is not liable for injuries or damages caused by failure to comply with these instructions. Product design may be updated for technical improvements.

IMPORTANT, À CONSERVER POUR RÉFÉRENCE FUTURE : LIRE ATTENTIVEMENT

Usage exclusivement domestique

1. Avertissements de sécurité et précautions

- Ne placez pas les meubles dans des zones exposées à une chaleur intense, à l'humidité ou au soleil direct.
- Évitez de placer des objets lourds sur la surface pour prévenir la déformation ou les dommages structurels.
- Assurez-vous que le sol est sec pour réduire les risques de glissade.

2. Guide d'assembly

- Ouvrez l'emballage et vérifiez que tous les composants sont présents.
- Vissez régulièrement les pieds pour éviter leur desserrage.

3. Instructions d'utilisation

- Répartissez uniformément le poids pour éviter une surcharge unilatérale.

4. Entretien et soin

- Surfaces en bois : Nettoyez à l'aide de chiffons secs ; évitez l'humidité.
- Plateaux en verre/céramique : Utilisez des nettoyeurs neutres ; ne mettez jamais d'agents acides ou abrasifs.
- Après nettoyage, conservez dans un endroit sec et bien ventilé ; évitez les environnements humides.

Le fabricant décline toute responsabilité en cas de blessures ou dommages dus au non-respect de ces instructions. La conception du produit peut être modifiée pour des améliorations techniques.

DE WICHTIG, FÜR ZUKÜNFTIGE REFERENZ AUFBEWAHREN: SORGFÄLTIG LESEN

Nur für den Hausgebrauch

1. Sicherheitswarnungen und Vorsichtsmaßnahmen

- Legen Sie Möbel nicht in Bereichen mit hoher Hitze, Feuchtigkeit oder direktem Sonneneinstrahlung.
- Vermeiden Sie das Aufstellen schwerer Gegenstände auf der Oberfläche, um strukturelle Verformungen oder Schäden zu verhindern.
- Stellen Sie sicher, dass der Boden trocken ist, um das Risiko von Rutschen zu minimieren.

2. Montieranleitung

- Öffnen Sie die Verpackung und prüfen Sie, ob alle Teile vorhanden sind.
- Schrauben Sie regelmäßig die Füße fest, um ein Lockerwerden zu verhindern.

3. Gebrauchsanweisung

- Verteilen Sie das Gewicht gleichmäßig, um ein einseitiges Überladen zu vermeiden.

4. Wartung und Pflege

- Holzoberflächen: Reinigen Sie ausschließlich mit trockenen Tüchern; vermeiden Sie Feuchtigkeit.
- Glas-/Keramikische Oberflächen: Verwenden Sie neutrale Reiniger; nie verwenden Sie aggressive Säuren oder Schleifmittel.
- Nach Reinigung lagern Sie das Möbel in einem trockenen, gut belüfteten Raum; vermeiden Sie feuchte Umgebungen.

Der Hersteller haftet nicht für Verletzungen oder Schäden, die durch die Nichtbeachtung dieser Anweisungen verursacht werden. Das Produktdesign kann aus technischen Gründen aktualisiert werden.

ES IMPORTANTE, CONSERVE PARA REFERENCIA FUTURA: LEA CUIDADOSAMENTE

Solo para uso doméstico

1. Advertencias de seguridad y precauciones

- No coloque los muebles en áreas expuestas a altas temperaturas, humedad o luz solar directa.
- Evite colocar objetos pesados en la superficie para prevenir deformaciones o daños estructurales.
- Asegúrese de que el suelo esté seco para reducir los riesgos de resbalones.

2. Guía de ensamblaje

- Abra el embalaje y verifique que todos los componentes estén presentes.
- Afirme periódicamente los pies para evitar que se afloren.

3. Instrucciones de uso

- Distribuya el peso de manera uniforme para evitar sobrecargas unilaterales.

4. Mantenimiento y cuidado

- Superficies de madera: Limpie con paños secos únicamente; evite la humedad.
- Mesas de vidrio/cerámica: Use limpiadores neutrales; nunca aplique agentes ácidos ni abrasivos.
- Tras limpiar, guárdelo en un lugar seco y bien ventilado; evite ambientes húmedos.

El fabricante no es responsable de lesiones o daños causados por el incumplimiento de estas instrucciones. El diseño del producto puede ser actualizado para mejoras técnicas.

PT IMPORTANTE, GARDE PARA REFERÊNCIA FUTURA: LEIA COM ATENÇÃO

Somente para uso doméstico

1. Avisos de Segurança e Precauções

- Não coloque os móveis em áreas expostas a altas temperaturas, umidade ou luz solar direta.
- Evite colocar objetos pesados na superfície para prevenir deformações ou danos estruturais.
- Assegure-se de que o chão esteja seco para reduzir os riscos de escorregões.

2. Guia de Montagem

- Abra o embalagem e verifique se todos os componentes estão presentes.
- Aperte periodicamente os pés para evitar que se soltem.

3. Instruções de Uso

- Distribua o peso de forma uniforme para evitar sobrecargas unilaterais.

4. Manutenção e Cuidado

- Superfícies de Madeira: Limpe com panos secos apenas; evite a umidade.
- Topes de Vidro/Cerâmica: Use limpadores neutros; nunca aplique agentes ácidos ou abrasivos.
- Após limpeza, guarde em local seco e bem ventilado; evite ambientes úmidos.

O fabricante não é responsável por ferimentos ou danos causados pelo não cumprimento dessas instruções. O design do produto pode ser atualizado para melhorias técnicas.

IT IMPORTANTE, CONSERVARE PER FUTURO RIFERIMENTO: LEGGERE ATTENTAMENTE

Solo per uso domestico

1. Avvisi di sicurezza e precauzioni

- Non posizionare i mobili in aree esposte a alte temperature, umidità o luce solare diretta.
- Evitate di posizionare oggetti pesanti sulla superficie per prevenire deformazioni o danni strutturali.
- Assicuratevi che il pavimento sia asciutto per ridurre il rischio di scivolamenti.

2. Guida all'assemblaggio

- Aprite l'imballaggio e verificate che tutti i componenti siano inclusi.
- Stringate regolarmente i piedi per evitare che si allentino.

3. Istruzioni d'uso

- Distribuite uniformemente il peso per evitare sovraccarichi unilaterali.

4. Manutenzione e cura

- Superfici in legno: Pulite esclusivamente con panni asciutti; evitate l'esposizione all'umidità.
- Tetti in vetro/ceramica: Utilizzate detergenti neutri; non applicate mai acidi o agenti abrasivi.
- Dopo la pulizia, conservate l'oggetto in un luogo asciutto e ben ventilato; evitate ambienti umidi.

Il produttore non è responsabile di lesioni o danni causati dalla mancata osservanza di queste istruzioni. Il design del prodotto può essere aggiornato per miglioramenti tecnici.

RO IMPORTANT, DE PĂSTRAT PENTRU REFERINȚE VIITOARE: CITIȚI CU ATENȚIE.

Doar pentru uz casnic

1. Avertismente și Precauții de Siguranță

- Nu așezați mobila în zone expuse la căldură ridicată, umiditate sau lumină directă a soarelui.
- Evitați plasarea obiectelor grele pe suprafață pentru a preveni deformarea structurală sau deteriorarea.
- Asigurați-vă că podeaua este uscată pentru a reduce riscul de alunecare.

2. Ghid de Asamblare

- Deschideți ambalajul și verificați dacă toate piesele sunt incluse.
- Strângeți periodic picioarele pentru a preveni slăbirea acestora.

3. Instrucțiuni de Utilizare

- Distribuți greutatea în mod uniform pentru a evita suprasolicitarea unei singure părți.

4. Întreținere și Ingrijire

- Suprafețe din Lemn: Curățați doar cu cârpe uscate; evitați umezeala.
- Blaturi din Sticlă/Ceramică: Utilizați detergenți neutri; nu aplicați niciodată agenți acizi sau abrazivi.
- Depozitați într-o zonă uscată și ventilată după curățare; evitați mediile umede.

Producătorul nu își asumă responsabilitatea pentru răniri sau daune cauzate de nerespectarea acestor instrucțiuni. Designul produsului poate fi actualizat pentru îmbunătățiri tehnice.

HARDWARE

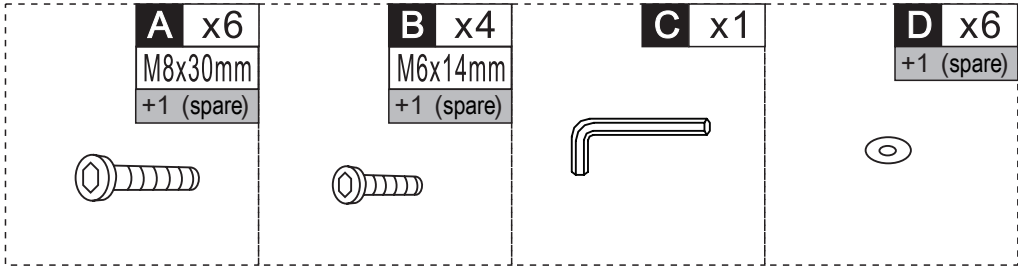

PARTS

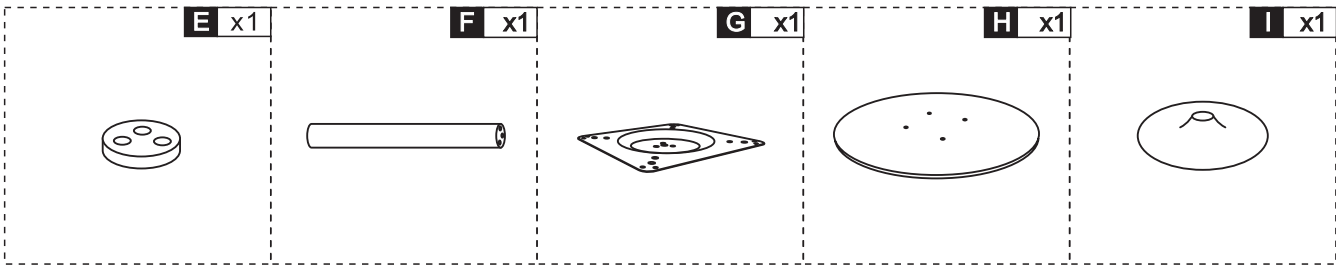

01

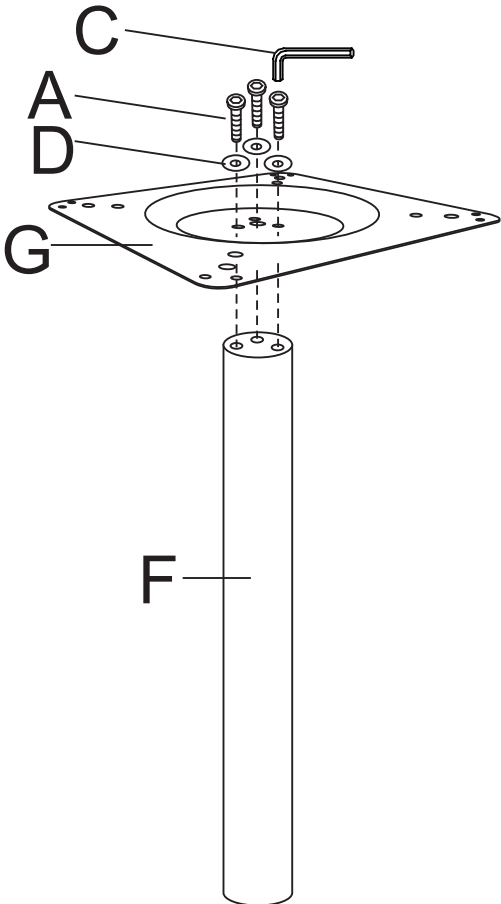
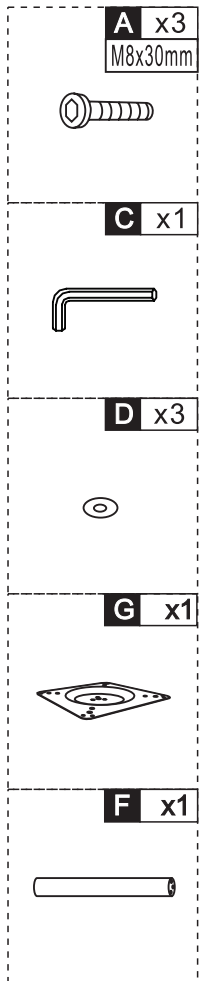

B x4
M6x14mm



C x1



H x1

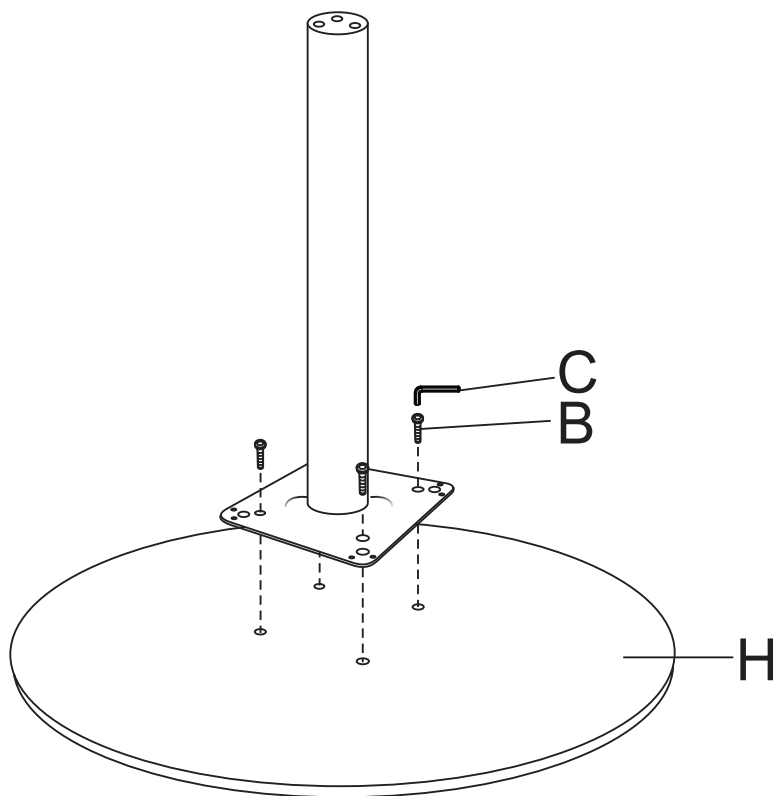

A x3
M8x30mm



C x1



D x3



E x1



I x1

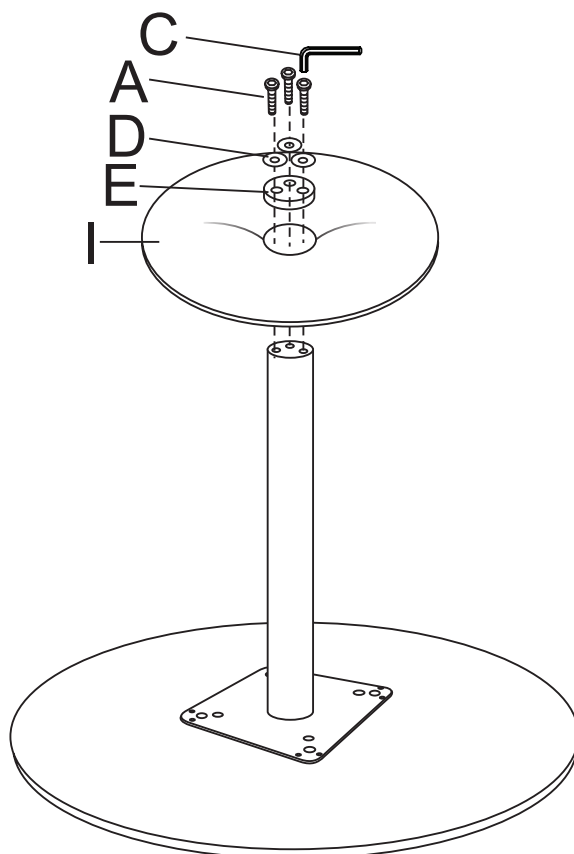

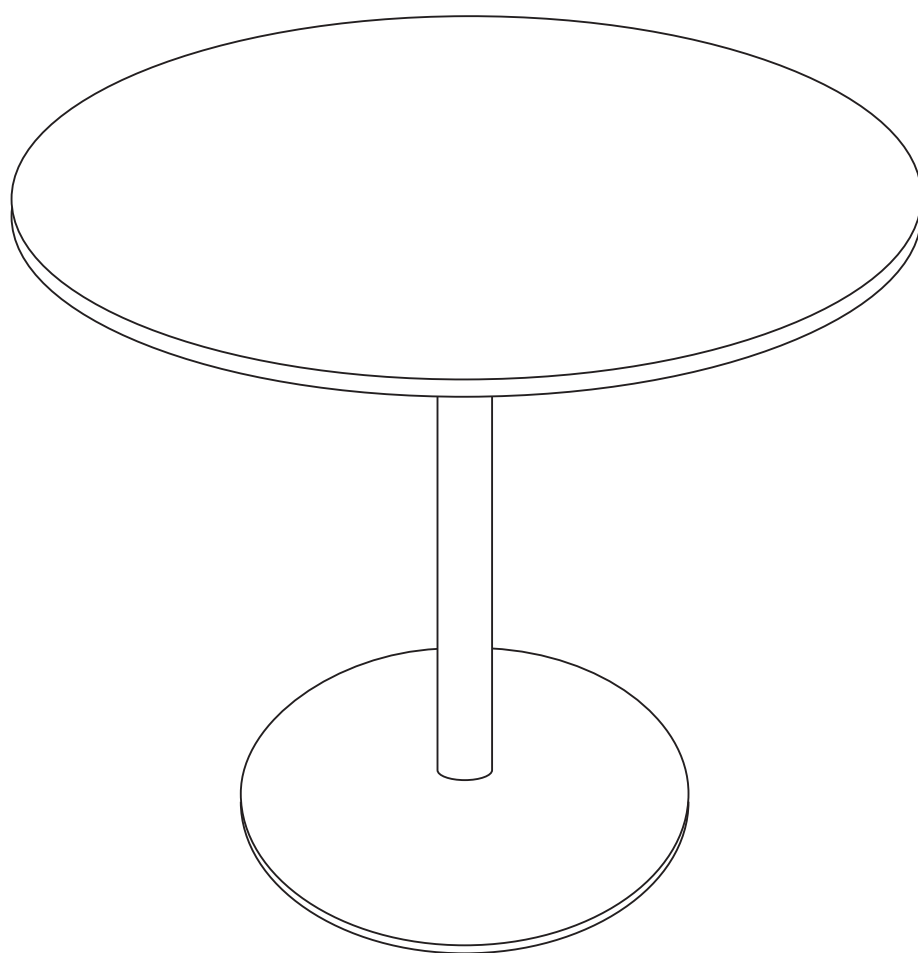

If you have any questions, please contact our customer care center, Our contact details are below:

US

 001-877-644-9366

 customerservice@aosom.com

Imported by Aosom LLC
7777 Center Ave. Suite 430
Huntington Beach, CA 92647-9998 USA
MADE IN CHINA

If you have any questions, please contact our customer care center, Our contact details are below:

CA

 416-792-6088

 customerservice@aosom.ca

Imported by Aosom Canada Inc.
Unit 33-1 Sparks Avenue, North York, Ontario,
Canada
M2H 2W1
MADE IN CHINA

Si vous avez la moindre question, veuillez contacter notre centre d'assistance à la clientèle, Nos coordonnées sont les suivantes:

 416-792-6088

 customerservice@aosom.ca

Importé par Aosom Canada Inc.
Unité 33-1 Sparks Avenue, North York, Ontario,
Canada M2H 2W1
Fabriqué en Chine

Si tiene alguna pregunta, comuníquese con nuestro Centro de Atención al Cliente, Nuestros datos de contacto son los siguientes:

ES

 0034-931294512

 atencioncliente@aosom.es

IMPORTADOR/Fabricante/REP:
SPANISH AOSOM, S.L.
C/ROC GROS, Nº15.08550, ELS HOSTALET DE
BALENYÀ, SPAIN.
B66295775
HECHO EN CHINA

Se tiver alguma dúvida, por favor contacte o nosso Centro de Atendimento ao Cliente, Os nossos dados de contacto são os seguintes:

 0034-931294512

 info@aosom.pt.

Si vous avez la moindre question, veuillez contacter notre centre d'assistance à la clientèle, Nos coordonnées sont les suivantes:

FR

 0033-1-84166106

 aosom@mhfrance.fr

Importé par/Fabricant/REP:
MH FRANCE
2 Rue Maurice Hartmann
92130 Issy Les Moulineaux
France
FABRIQUÉ EN CHINE



FR

**DONNEZ
OU
RECYCLEZ**



ASSOCIATION

OU



LIVRAISON

OU



DÉCHÈTERIE

Adresses sur quefairedemesdechets.fr

If you have any questions, please contact our customer care center, Our contact details are below:

UK

 0044-800-240-4004

 enquiries@mhstar.co.uk

IMPORTER ADDRESS:
MH STAR UK LTD
1 Northampton Cross Logistics Park
Northampton Cross Road
Northampton
Nn4 9FH
Tel: 0800 240 4050
enquiries@mhstar.co.uk
MADE IN CHINA

Wenn Sie Fragen haben, wenden Sie sich bitte an unser Kundendienstzentrum, Unsere Kontaktdaten stehen unten:

DE

 0049-0(40)-87408465

 service@aosom.de

ADRESSE DES IMPORTEURE/Hersteller/REP:
MH Handel GmbH
Wendenstraße 309
D-20537 Hamburg
Germany
IN CHINA HERGESTELLT

In caso di dubbio, si prega di contattare il nostro centro assistenza clienti, I nostri dettagli di contatto sono di seguito:

IT

 0039-0249471447

 clienti@aosom.it

IMPORTATO DA/Produttore/REP:
AOSOM Italy srl
Centro Direzionale Milanofiori
Strada 1 Palazzo F1
20057 Assago (MI)
P.I.: 08567220960
FATTO IN CINA

Importator/Producător/REP:

RO

Aosom Romania SRL
Str. Barbu Mumuleanu, nr. 30-32
Bucuresti, Sector 2
Tel: +40 312294730
clienti@aosom.ro
Fabricat in China