

EN_IMPORTANT, RETAIN FOR FUTURE REFERENCE: READ CAREFULLY.

FR_IMPORTANT: A LIRE ATTENTIVEMENT ET A CONSERVER POUR VOUS Y REFRERER ULTERIEUREMENT

ES_IMPORTANTE, LEA DETENIDAMENTE Y GUARDE PARA FUTURAS REFERENCIAS.

PT_IMPORTANTE, GARDE PARA FUTURA REFERÊNCIA, LEIA ATENTAMENTE.

DE_WICHTIG! SORFGFÄLTIG LESEN UND FÜR SPÄTERES NACHSCHLAGEN AUFBEWAHREN.

IT_IMPORTANTE, LEGGERE E CONSERVARE QUESTO MANUALE D'ISTRUZIONE PER UN USO FUTURO.

RO_IMPORTANT, DE PĂSTRAT PENTRU REFERINȚE VIITOARE: CITIȚI CU ATENȚIE.

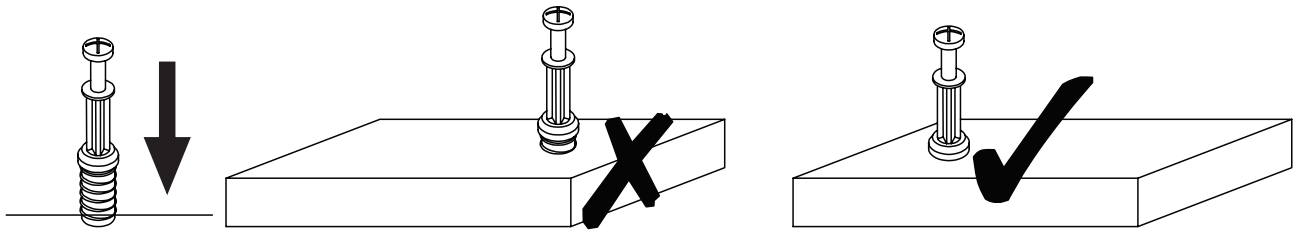

EN_ QUICKFIT: Tighten quickfit until shoulder is flush with panel. Do not overtighten or undertighten.

FR_ RACCORD RAPIDE: Faites serrer le raccord rapide jusqu'à ce que l'épaulement soit parfaitement encastré dans le panneau. Il ne faut ni trop serrer ni insuffisamment serrer.

ES_ QUICKFIT: Apriete quickfit hasta que el hombro se descargue con el panel. NO lo sobreapriete ni lo apriete poco.

PT_ AJUSTE RÁPIDO: Aperte o ajuste rápido até estar nivelada com o painel. Não apertar demasiado ou excessivamente.

DE_ QUICKFIT: Ziehen Sie den Quickfit fest, bis die Schulter mit der Platte bündig ist. Bitte nicht zu fest oder zu schwach anziehen.

IT_ MONTAGGIO RAPIDO: Stringere il montaggio rapido fino a quando la spalla è a filo con il pannello, non stringere troppo o troppo poco.

RO_ QUICKFIT: Strângeți quickfit până când umărul este la același nivel cu panoul. Nu strângeți prea tare și nici prea slab.

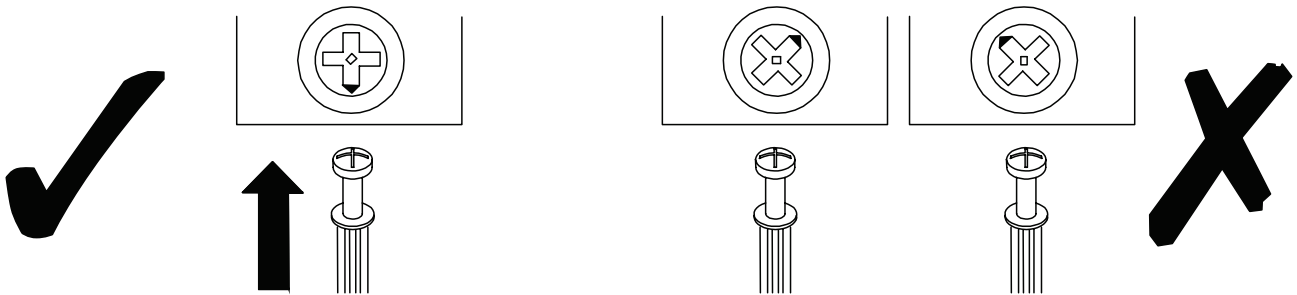

EN_ CAM LOCK: When fitting cam lock, ensure starting position is correct before you insert connecting quickfit.

FR_ SERRURE BATTEUSE: Avant d'insérer la serrure batteuse, veillez à la bonne orientation avant d'insérer le raccord rapide.

ES_ CIERRE DE LA CÁMARA: Cuando instale el cierre de la cámara, asegúrese de que la posición de inicio es correcta antes de que inserte el quickfit conector.

PT_ BLOQUEIO: Ao instalar o bloqueio, assegurar-se de que a posição inicial está correcta antes de inserir o encaixe de ligação rápida.

DE_ CAM-LOCK: Achten Sie bei der Montage des Cam-Locks auf die richtige Ausgangsposition, bevor Sie den Quickfit einsetzen.

IT_ BLOCCAGGIO A CAMMA: Quando si monta il bloccaggio a camma, assicurarsi che la posizione iniziale sia corretta prima di inserire il montaggio rapido di collegamento.

RO_ BLOCARE CU CAME: Când montați blocarea cu came, asigurați-vă că poziția inițială este corectă înainte de a introduce racordul rapid.

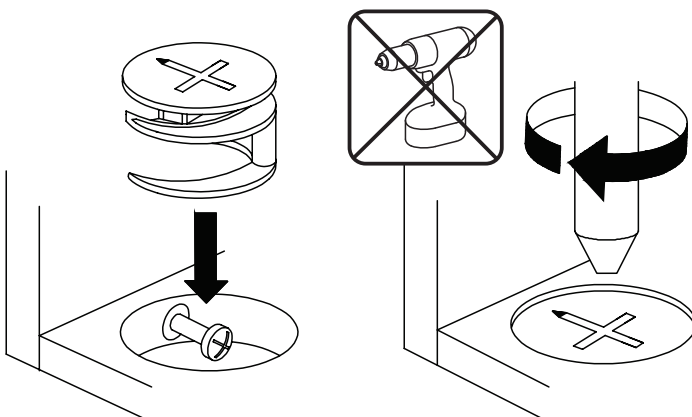

EN_ Turn cam lock clockwise to tighten.

FR_ Faites tourner la serrure batteuse dans le sens des aiguilles d'une montre pour la resserrer.

ES_ Gire el cierre de la cámara en sentido horario para apretarlo.

PT_ Rodar o bloqueio no sentido dos ponteiros do relógio para o apertar.

DE_ Drehen Sie den Cam-Lock im Uhrzeigersinn, um ihn festzuziehen.

IT_ Ruotare il bloccaggio a camma in senso orario per stringere.

RO_ Rotiți blocarea cu came în sensul acelor de ceasornic pentru a strânge.

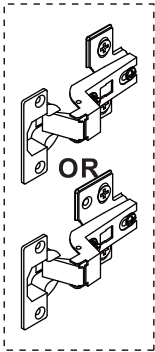

EN_ It may be necessary to adjust the hinges so that the doors align. Use the instructions below as a guide.

FR_ Il est parfois nécessaire d'ajuster les charnières pour un meilleur alignement des portes. Servez-vous des instructions ci-dessous comme guide.

ES_ Puede que sea necesario ajustar los quicios de forma que se alineen las puertas. Use las instrucciones que aparecen debajo como guía.

PT_ Pode ser necessário ajustar as dobradiças para que as portas fiquem alinhadas. Utilizar as instruções abaixo como guia.

DE_ Möglicherweise müssen Sie die Scharniere so einstellen, dass die Türen ausgerichtet sind. Verwenden Sie die nachstehenden Anweisungen als Leitfaden.

IT_ Potrebbe essere necessario regolare le cerniere in modo che le porte siano allineate. Per fare ciò attenersi alle istruzioni sottostanti.

RO_ Poate fi necesar să reglați balamalele pentru ca ușile să se alinieze. Folosiți instrucțiunile de mai jos ca ghid.

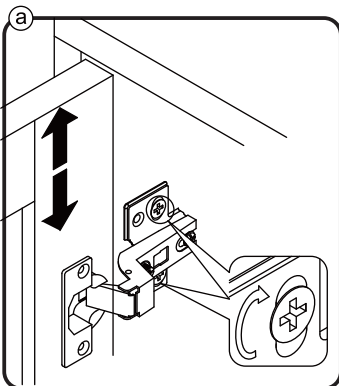

EN_ To adjust the door vertically loosen the screw as shown and move up and down as needed.

FR_ Si vous souhaitez régler la porte verticalement, desserrez la vis comme indiqué et déplacez la porte de haut en bas selon les besoins.

ES_ Para ajustar la puerta verticalmente afloje el tornillo tal y como se muestra y muévelo hacia arriba o hacia abajo según sea necesario.

PT_ Para ajustar a porta na vertical, soltar o parafuso mostrado e mover-se para cima e para baixo, conforme necessário.

DE_ Um die Tür vertikal auszurichten, lösen Sie die Schraube wie abgebildet und bewegen Sie sie nach Bedarf nach oben oder nach unten.

IT_ Per allineare la porta verticalmente allentare la vite come mostrato e spostarla in alto o in basso secondo necessità.

RO_ Pentru a regla ușa pe verticală, slăbiți șurubul așa cum se arată și mișcați în sus și în jos, după cum este necesar.

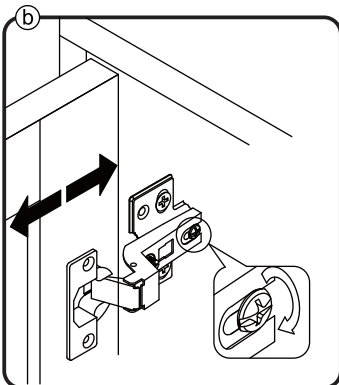

EN_ To adjust the gap from the door to the main frame turn the screw clockwise or anti-clockwise as needed.

FR_ Si vous souhaitez ajuster l'écart entre la porte et le cadre principal, tournez la vis dans le sens des aiguilles d'une montre ou dans le sens inverse, si nécessaire.

ES_ Para ajustar el espacio desde la puerta al marco principal, gire el tornillo en sentido horario o antihorario, según se necesite.

PT_ Para ajustar o espaço entre a porta e o quadro principal, rode o parafuso no sentido dos ponteiros do relógio ou anti-horário, conforme necessário.

DE_ Um den Abstand von der Tür zum Hauptrahmen auszurichten, drehen Sie die Schraube je nach Bedarf im oder gegen den Uhrzeigersinn.

IT_ Per regolare lo spazio tra la porta e il telaio principale, avvitate o svitate la vite secondo necessità.

RO_ Pentru a regla distanța dintre ușă și cadrul principal, rotiți șurubul în sensul acelor de ceasornic sau în sens invers acelor de ceasornic, după cum este necesar.

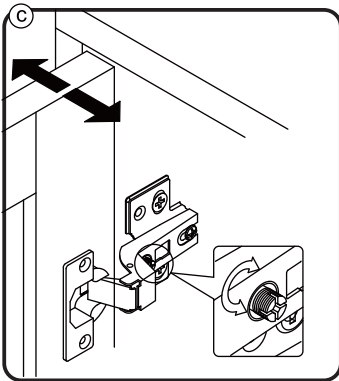

EN_ To adjust the door laterally adjust the screw as shown by turning clockwise or anti-clockwise.

FR_ Si vous souhaitez ajuster la porte latéralement, ajustez la vis comme indiqué en tournant dans le sens des aiguilles d'une montre ou dans le sens inverse des aiguilles d'une montre.

ES_ Para ajustar la puerta lateralmente ajuste el tornillo tal y como se muestra girándolo en sentido horario y antihorario.

PT_ Para ajustar a porta lateralmente ajustar o parafuso, conforme indicado, rodando no sentido dos ponteiros do relógio ou no sentido anti-horário.

DE_ Um die Tür seitlich auszurichten, stellen Sie bitte die Schraube wie abgebildet durch Drehen im oder gegen den Uhrzeigersinn ein.

IT_ Per allineare la porta lateralmente regolare la vite come mostrato, avvitala o svitala.

RO_ Pentru a regla ușa lateral, reglați șurubul așa cum se arată, rotindu-l în sensul acelor de ceasornic sau în sens invers acelor de ceasornic.

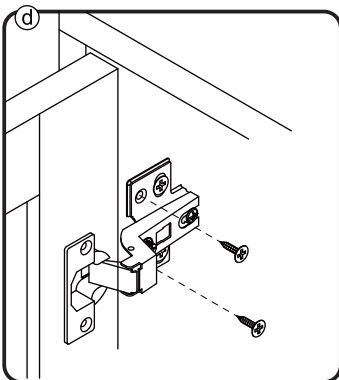

EN_ Please fix other screws

FR_ Merci de serrer les autres vis.

ES_ Fije los demás tornillos





PT_ Por favor fixe os outros parafusos

DE_ Befestigen Sie bitte die anderen Schrauben



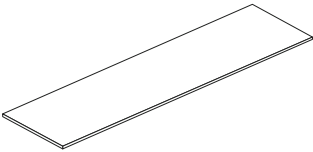

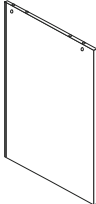
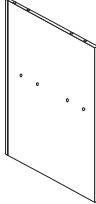
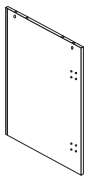
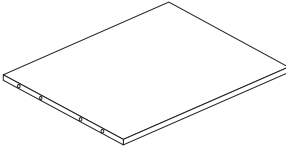
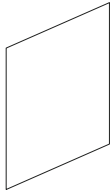
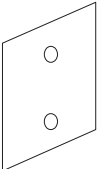
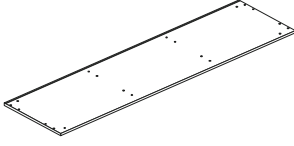
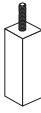
IT_ Fissare le altre viti

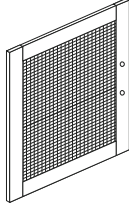
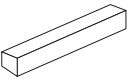
RO_ Vă rugăm să fixați celelalte șuruburi.

PARTS

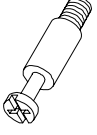
 1 x1	 2 x1	 3 x1	 4 x1
 5 x1	 6 x1	 7 x2	 8 x1
 9 x1	 10 x1	 11 x4	 12 x2
 13 x2			

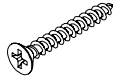
HARDWARE

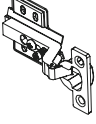
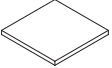
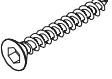
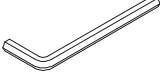
 A x12 6x35mm +1(spare)	 B x12 15x9.6mm +1(spare)	 C x24 6x30mm +1(spare)	 D x 8 4x35mm +1(spare)
 E x 4 4x30mm +1(spare)	 F x24 4x14mm +1(spare)	 G x4	 H x 5
 I x 4	 J x 1		

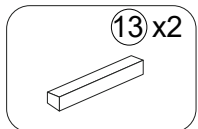

13 x2

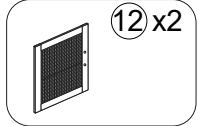

12 x2

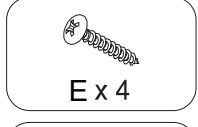

E x 4

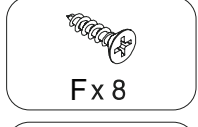

F x 8



G x 4

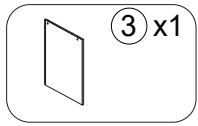
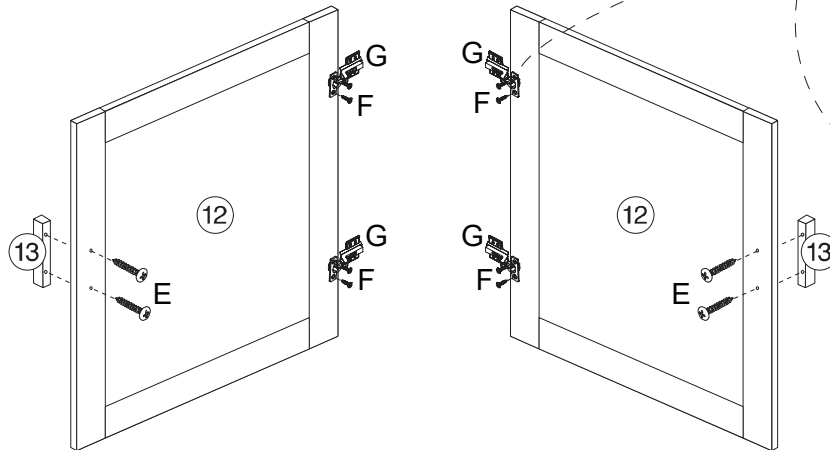

3 x1

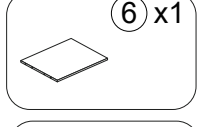

6 x1

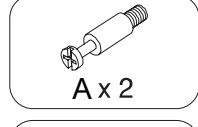

A x 2

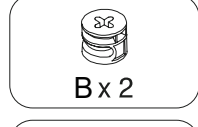

B x 2

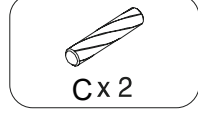

C x 2

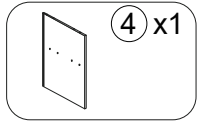
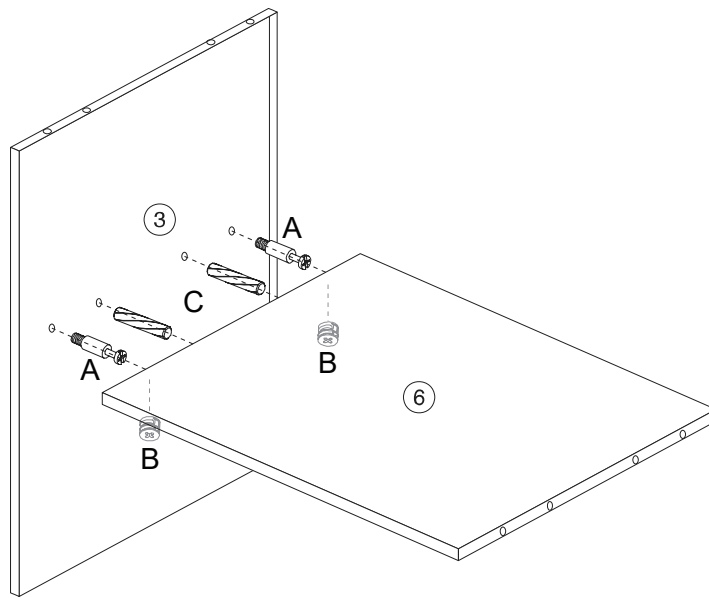

4 x1

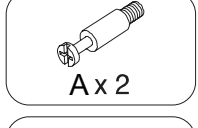

A x 2

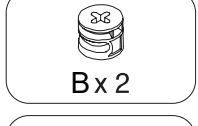

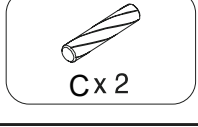

B x 2



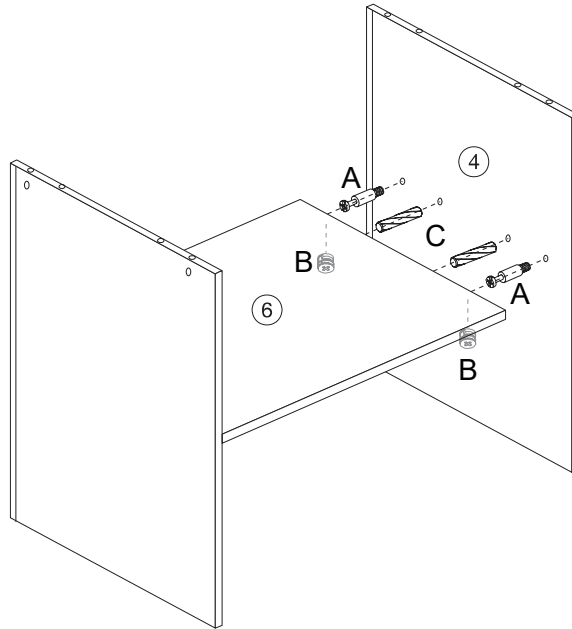

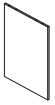
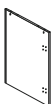
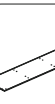

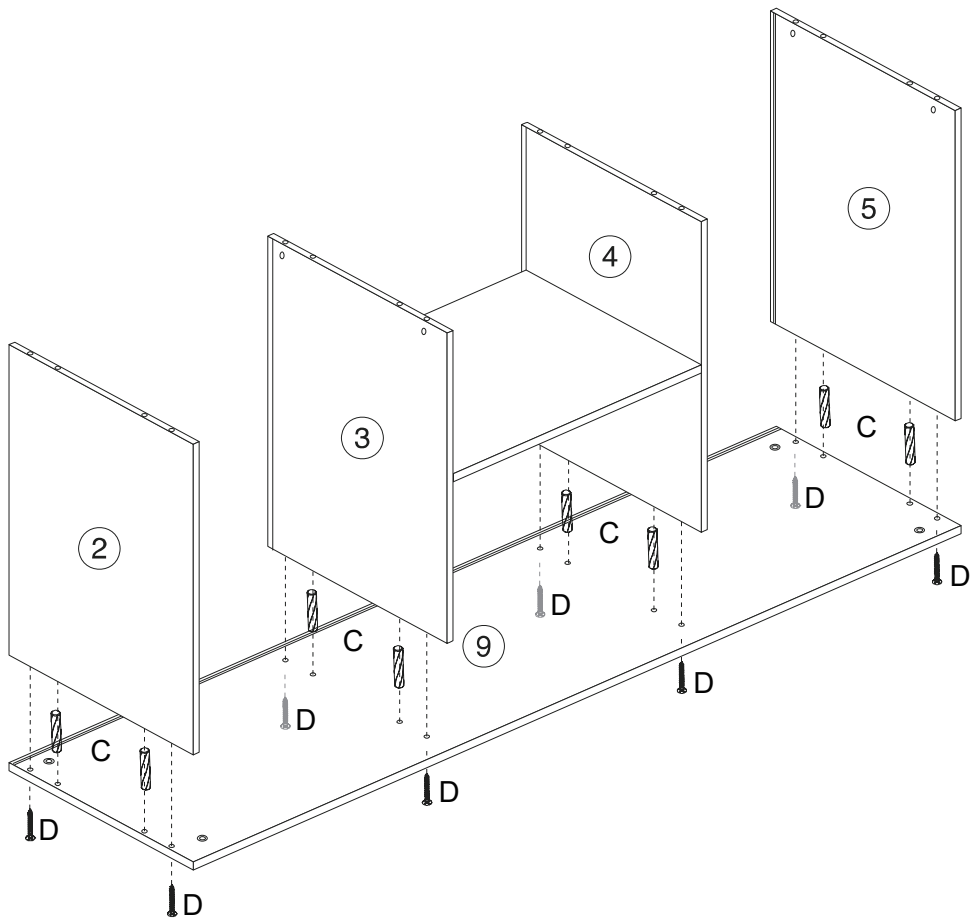

C x 2

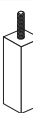

-  ② x1
-  ⑤ x1
-  ⑨ x1
-  C x 8
-  D x 8



-  ⑩ x1
-  ⑪ x4
-  C x 4
-  H x 5
-  I x 4
-  J x 1

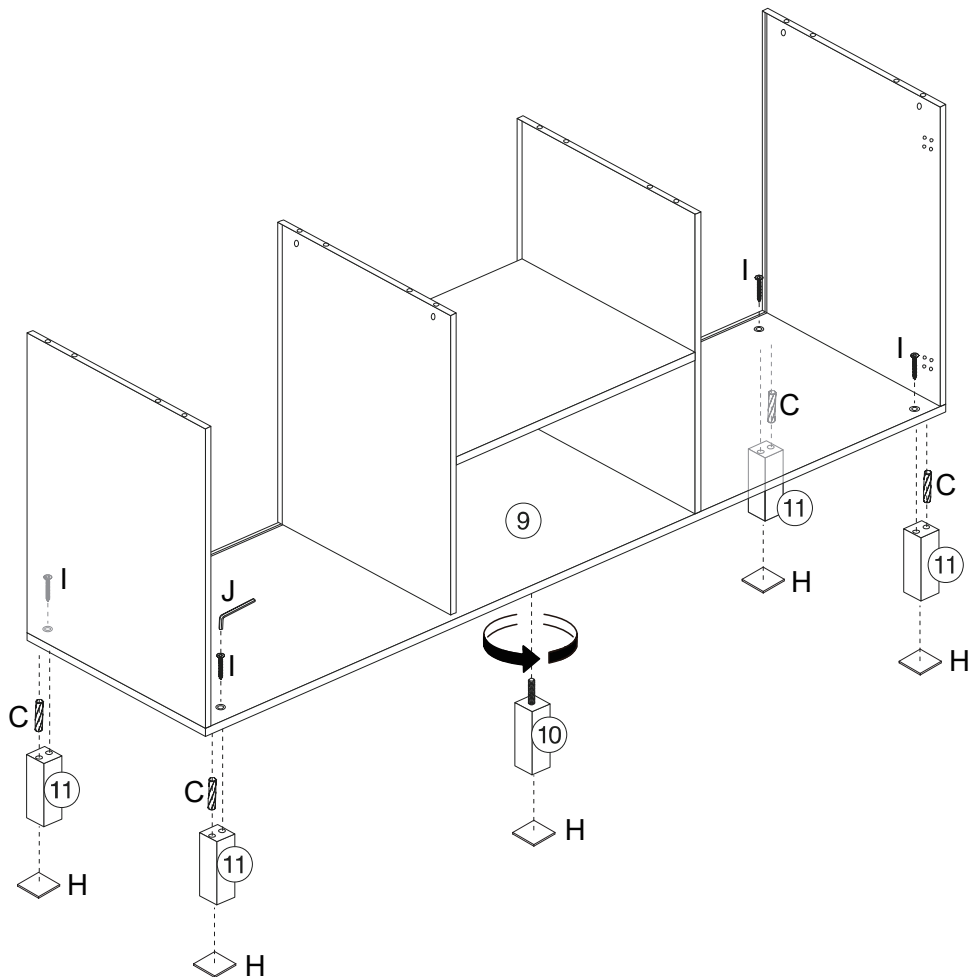

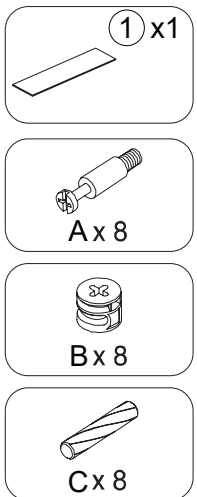
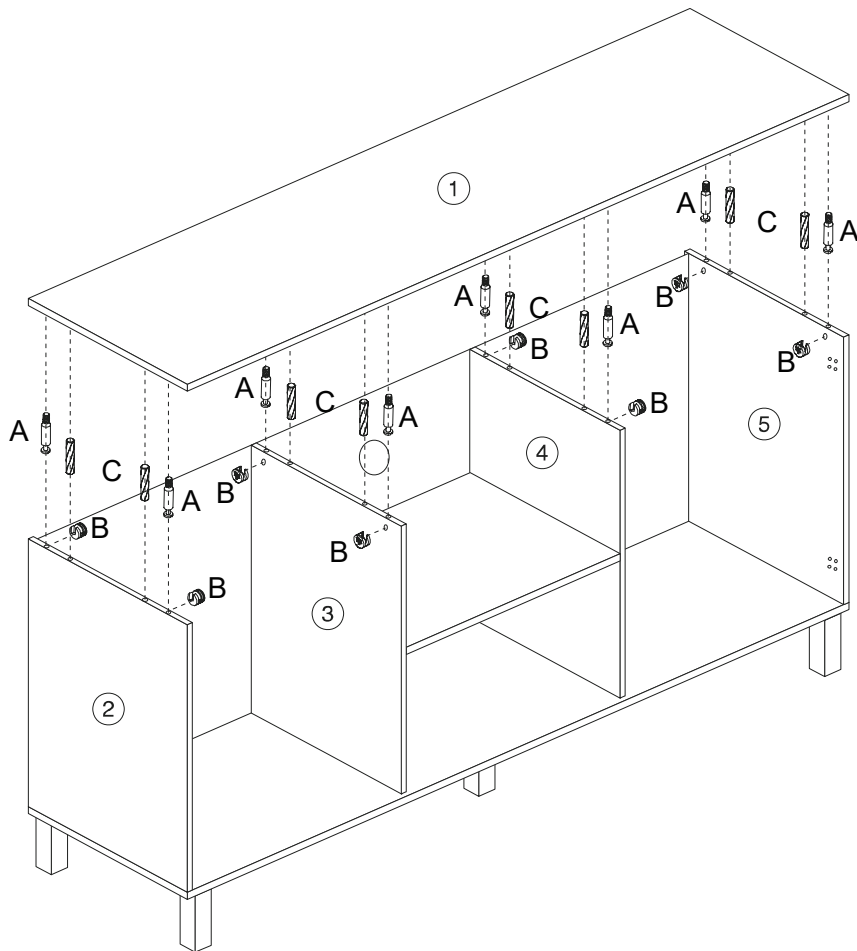
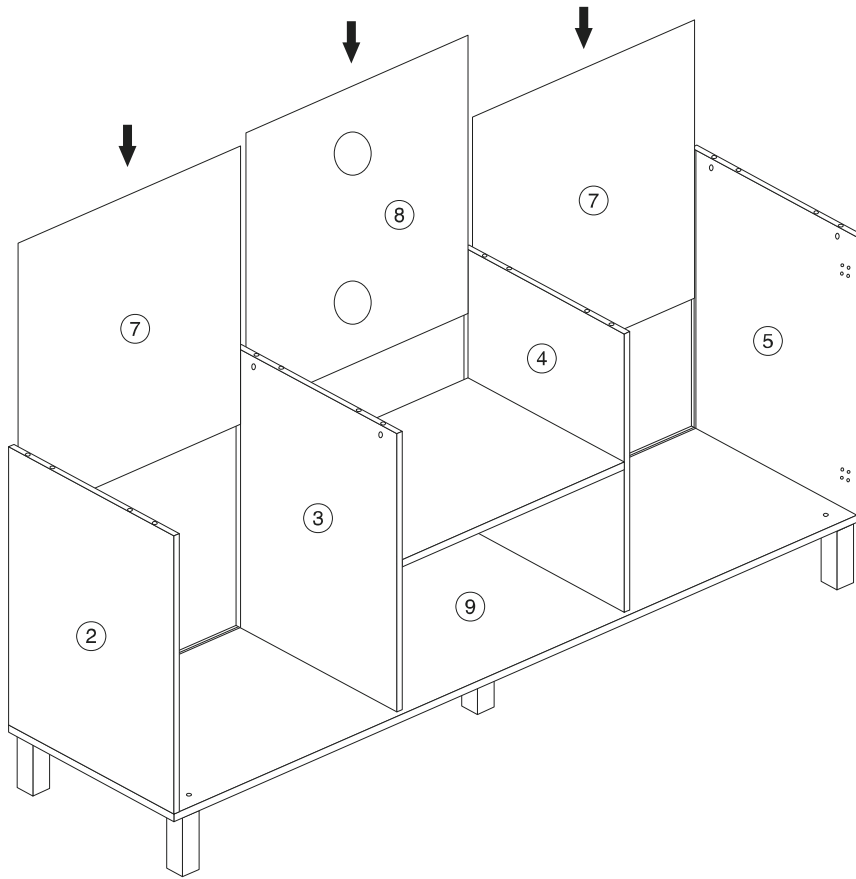
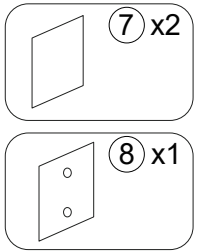

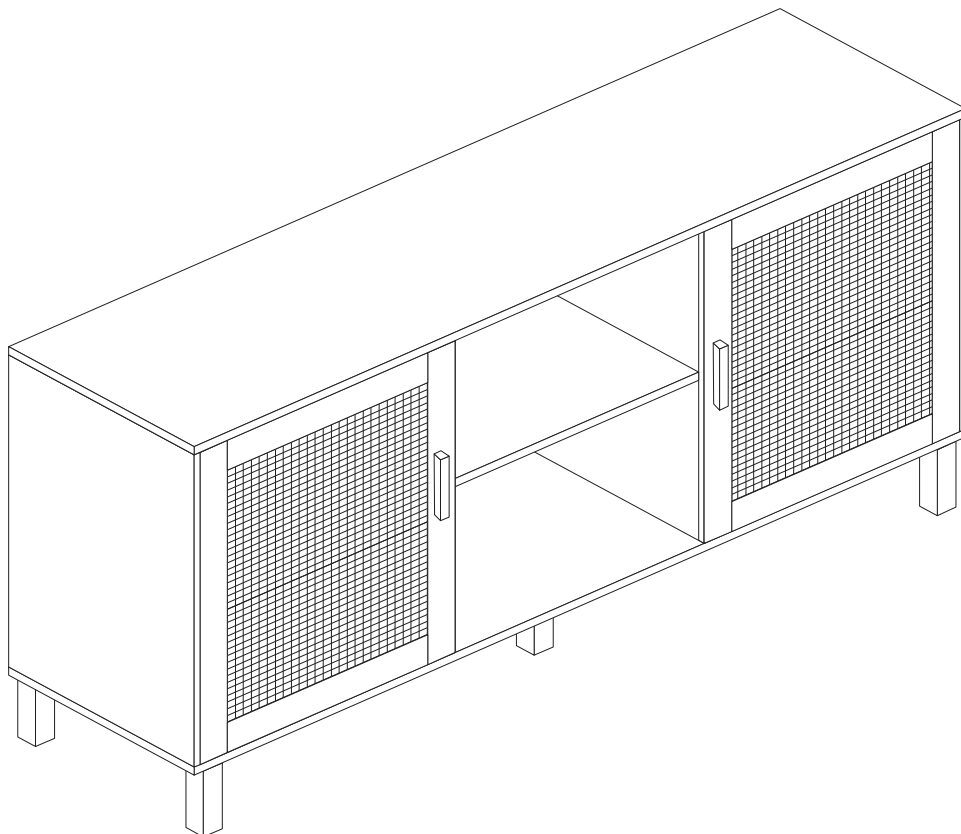
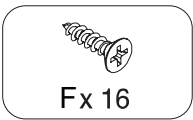
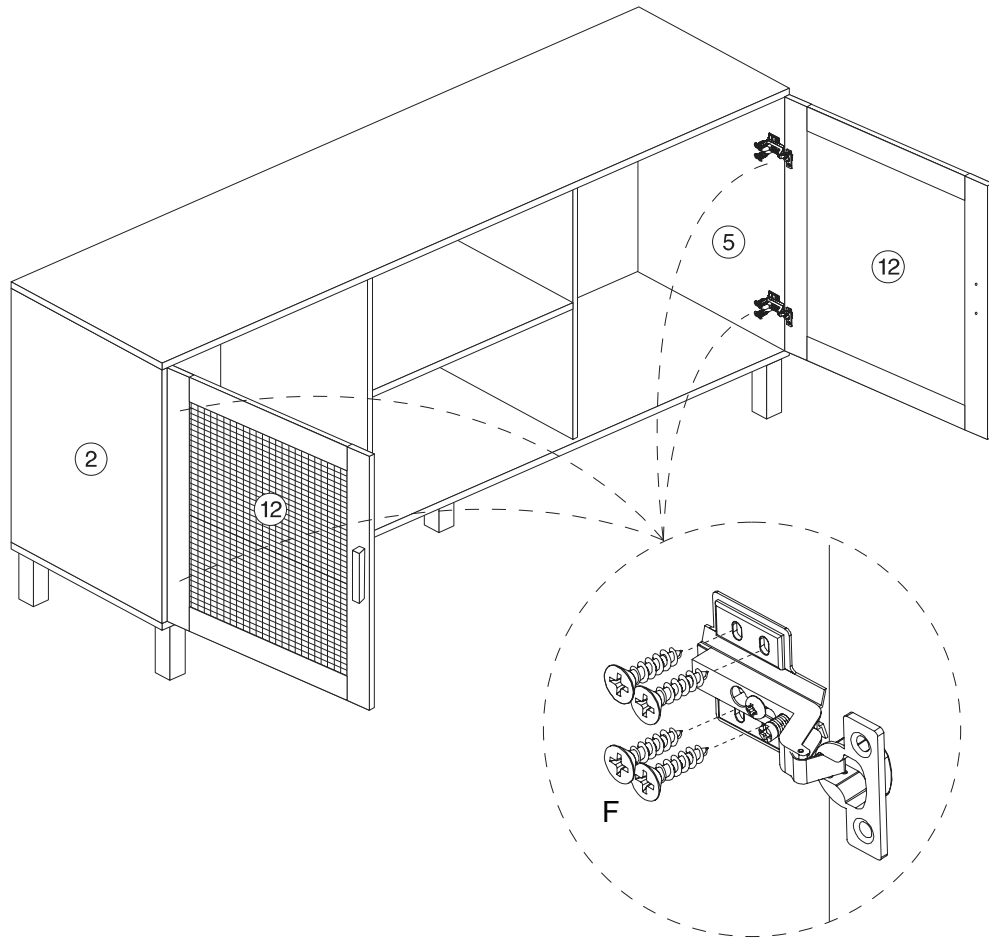



If you have any questions, please contact our customer care center, Our contact details are below:

US

 001-877-644-9366

 customerservice@aosom.com

Imported by Aosom LLC
7777 Center Ave. Suite 430
Huntington Beach, CA 92647-9998 USA
MADE IN CHINA

Wenn Sie Fragen haben, wenden Sie sich bitte an unser Kundendienstzentrum, Unsere Kontaktdaten stehen unten:

DE

 +49 40 87408465

 service@aosom.de

ADRESSE DES IMPORTEURE/Hersteller/REP:
MH Handel GmbH
Wendenstraße 309
D-20537 Hamburg
Germany
IN CHINA HERGESTELLT

If you have any questions, please contact our customer care center, Our contact details are below:

CA

 416-792-6088

 customerservice@aosom.ca

Imported by Aosom Canada Inc.
7270 Woodbine Avenue, Unit 307, Markham,
Ontario Canada L3R 4B9
MADE IN CHINA

Si vous avez la moindre question, veuillez contacter notre centre d'assistance à la clientèle, Nos coordonnées sont les suivantes:

 416-792-6088

 customerservice@aosom.ca

Importé par Aosom Canada Inc.
7270 Woodbine Avenue, unité 307,
Markham, Ontario Canada L3R 4B9
FABRIQUÉ EN CHINE

In caso di dubbio, si prega di contattare il nostro centro assistenza clienti, I nostri dettagli di contatto sono di seguito:

IT

 0039-0249471447

 clienti@aosom.it

IMPORTATO DA/Produttore/REP:
AOSOM Italy srl
Centro Direzionale Milanofiori
Strada 1 Palazzo F1
20057 Assago (MI)
P.I.: 08567220960
FATTO IN CINA

Si tiene alguna pregunta, comuníquese con nuestro Centro de Atención al Cliente, Nuestros datos de contacto son los siguientes:

ES

 0034-931294512

 atencioncliente@aosom.es

IMPORTADOR/Fabricante/REP:
SPANISH AOSOM, S.L.
C/ROC GROS, N°15.08550, ELS HOSTALETES DE
BALENYÀ, SPAIN.
B66295775
HECHO EN CHINA

Se tiver alguma dúvida, por favor contacte o nosso Centro de Atendimento ao Cliente, Os nossos dados de contacto são os seguintes:

 0034-931294512

 info@aosom.pt.

IMPORTADOR/Fabricante/REP:
SPANISH AOSOM, S.L.
C.ROC GROS N.15, 08550. ELS HOSTALETES DE
BALENYÀ
FEITO NA CHINA

If you have any questions, please contact our customer care center, Our contact details are below:

UK

 0044-800-240-4004

 enquiries@mhstar.co.uk

IMPORTER ADDRESS:
MH STAR UK Ltd
1 Northampton Cross Logistics Park
Northampton Cross Road
Northampton
NN4 9FH
MADE IN CHINA

Si vous avez la moindre question, veuillez contacter notre centre d'assistance à la clientèle, Nos coordonnées sont les suivantes:

FR

 0033-1-84166106

 aosom@mhfrance.fr

Importé par/Fabricant/REP:
MH FRANCE
2 Rue Maurice Hartmann
92130 Issy Les Moulineaux
France
FABRIQUÉ EN CHINE



FR

**DONNEZ
OU
RECYCLEZ**



ASSOCIATION

OU



LIVRAISON

OU



DÉCHÈTERIE

Adresses sur quefairedemesdechets.fr