

PawHut

IN220900894V01

D30-651V00

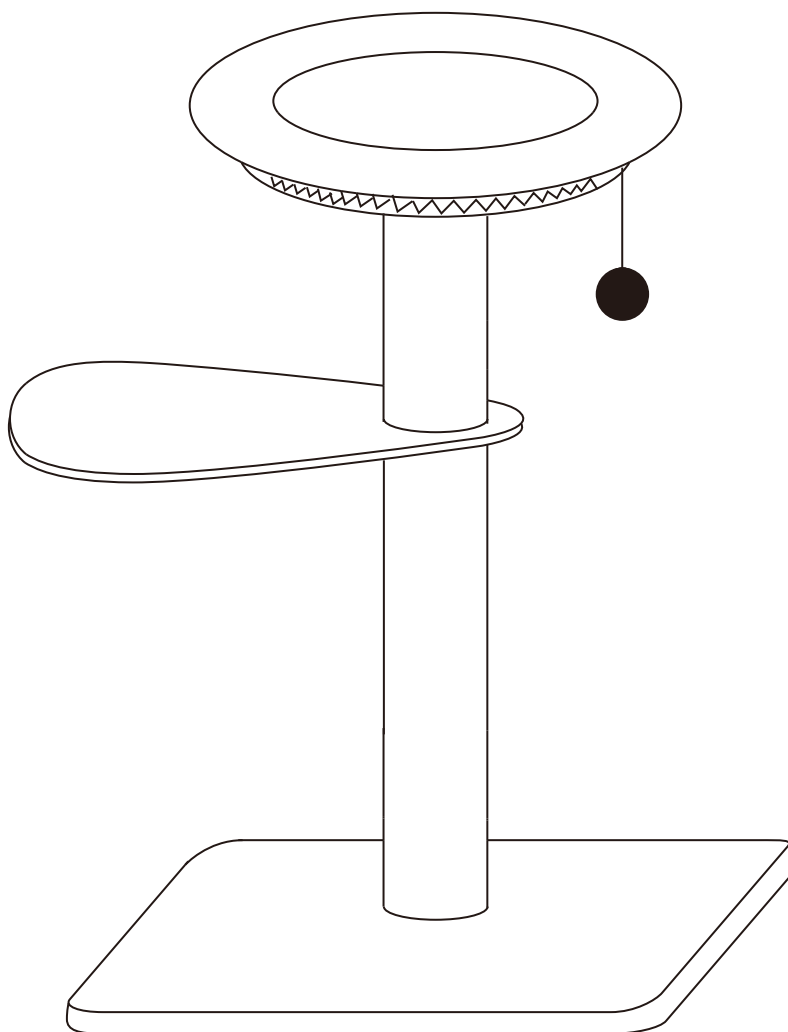

2

STEPS



20 MIN

EN_ IMPORTANT, RETAIN FOR FUTURE REFERENCE: READ CAREFULLY.

FR_ IMPORTANT: A LIRE ATTENTIVEMENT ET À CONSERVER POUR CONSULTATION ULTÉRIEURE.

ES_ IMPORTANTE, LEA Y GUARDE PARA FUTURAS REFERENCIAS.

PT_ IMPORTANTE: LEIA ATENTAMENTE E GUARDE PARA CONSULTA FUTURA.

DE_ WICHTIG! SORGFÄLTIG LESEN UND FÜR SPÄTER NACHSCHLAGEN AUFBEWAHREN.

IT_ IMPORTANTE! CONSERVARE IL PRESENTE MANUALE PER FUTURO RIFERIMENTO E LEGGERLO ATTENTAMENTE.

RO_ IMPORTANT: CITIȚI CU ATENȚIE ȘI PĂSTRAȚI PENTRU CONSULTARE VIITOARE.

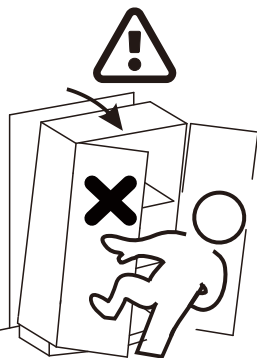
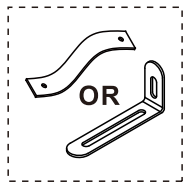

EN_ This is anti-dumping belt that fix the product to the wall and it can be used or not follow your needs.

FR_ Cette sangle anti-basculement permet de fixer le produit au mur. Elle peut être utilisée ou non selon vos besoins.

ES_ Esta es una correa anti-vuelco para fijar el producto a la pared, y según sus necesidades, puede utilizarla o no.

PT_ Este é o sistema anti-tombo que fixa o produto à parede e pode ser usado para uma maior segurança.

DE_ Dies ist Anti-Sturz-Gurt, um das Gerät an der Wand zu befestigen und es kann je nach Bedarf verwendet oder nicht verwendet werden.

IT_ Questa è una cintura anticaduta che fissa il prodotto alla parete e può essere utilizzata o meno a seconda delle vostre esigenze.

RO_ Aceasta este o centură anti-dumping care fixează produsul pe perete și poate fi utilizată sau nu, în funcție de necesități.

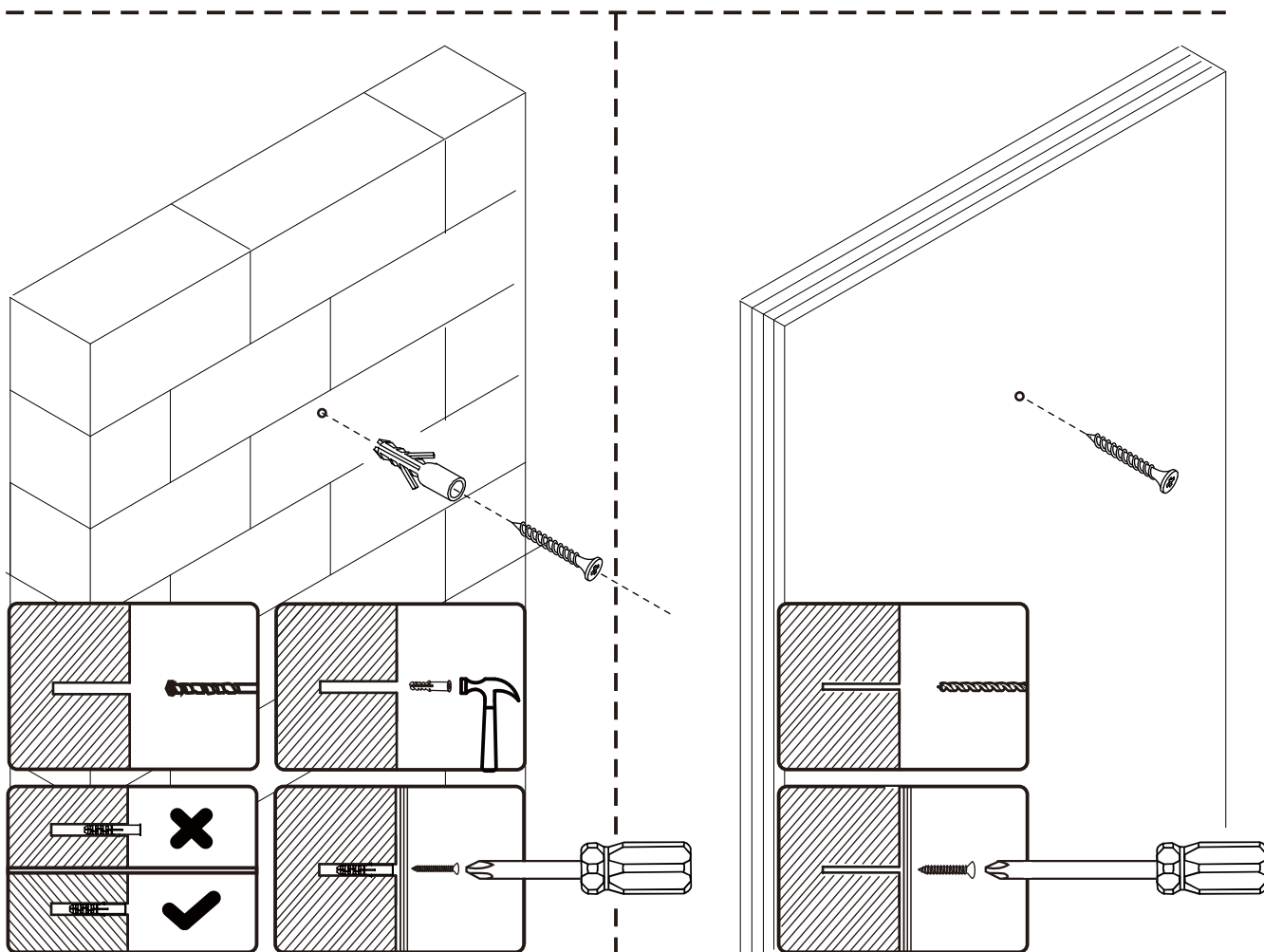

EN_ If it is a solid wall, please use expansion and self-tapping screws, if it is a wooden wall, only use self-tapping screws, please do not overtighten the screws

FR_ Si le mur est massif, veuillez utiliser des chevilles à expansion et des vis autotaraudeuses, mais s'il s'agit d'un mur en bois, utilisez uniquement des vis autotaraudeuses et ne serrez pas trop les vis.

ES_ Para una pared sólida, utilice los tornillos de expansión y autorroscantes. Para una pared de madera, utilice exclusivamente los tornillos autorroscantes, no los apriete demasiado.

PT_ Se for uma parede sólida, use por favor parafusos de expansão e auto-roscantes, se for uma parede de madeira, use apenas parafusos auto-roscantes, por favor não aperte demasiado os parafusos.

DE_ Wenn es sich um eine Massivwand handelt, verwenden Sie bitte Dehnungs- und selbstschneidende Schrauben. Wenn es sich um eine Holzwand handelt, verwenden Sie nur selbstschneidende Schrauben, bitte ziehen Sie die Schrauben nicht zu fest an.

IT_ Se si tratta di un muro solido, utilizzare sia viti ad espansione che autofilettanti. Se si tratta di una parete in legno, utilizzare solo viti autofilettanti, non stringere eccessivamente le viti.

RO_ Dacă este un perete solid, vă rugăm să utilizați șuruburi cu expansiune și autofiletante, dacă este un perete din lemn, utilizați numai șuruburi autofiletante, vă rugăm să nu strângeți excesiv șuruburile.

PARTS

1 x1

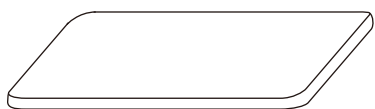

2 x1

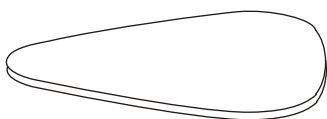

3 x1

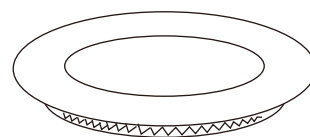

4 x1



5 x1



6 x 1

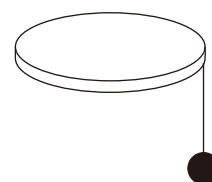

HARDWARE

A x3
M10*70

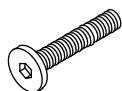

B x1
M10*85



C x1
M10*62



D x1

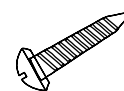

E x1



F x1

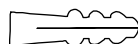



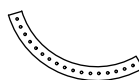



G x1



H x1
M5



-  AX3
-  BX1
-  CX1
-  DX1
-  EX1
-  FX1
-  GX1

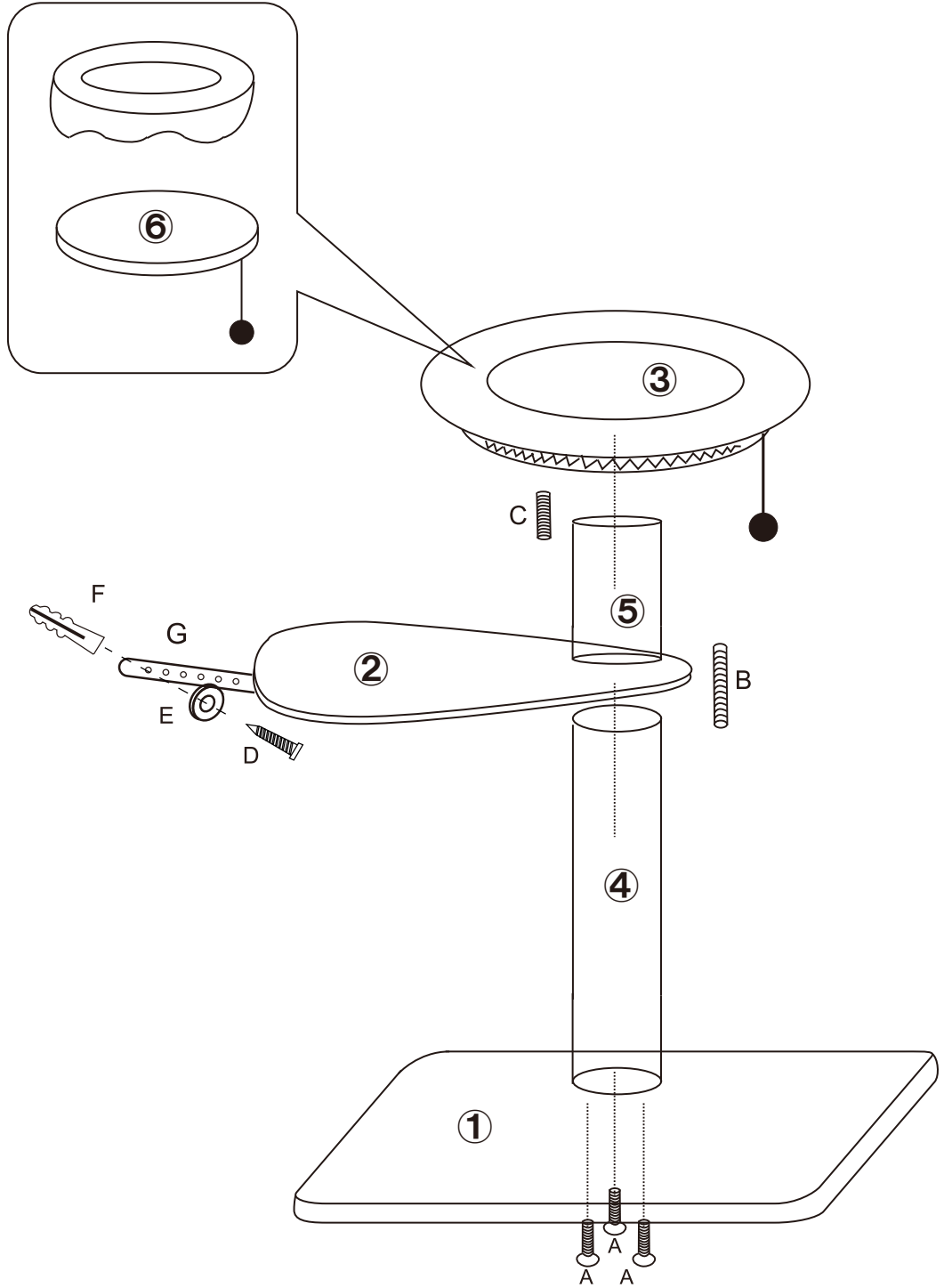

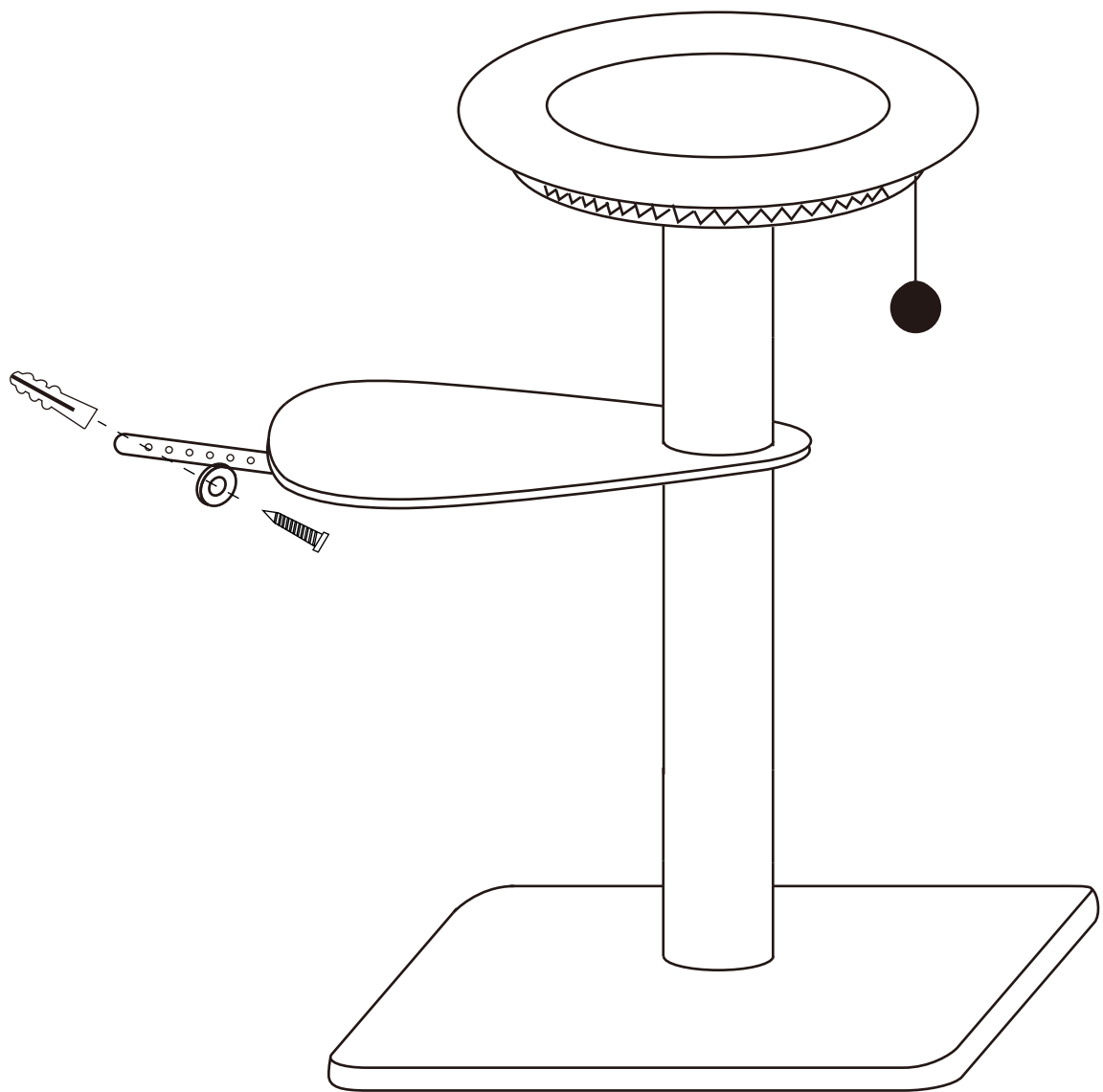

If you have any questions, please contact our customer care center, Our contact details are below:

US

 001-877-644-9366

 customerservice@aosom.com

Imported by Aosom LLC
7777 Center Ave. Suite 430
Huntington Beach, CA 92647-9998 USA
MADE IN CHINA

If you have any questions, please contact our customer care center, Our contact details are below:

CA

 416-792-6088

 customerservice@aosom.ca

Imported by Aosom Canada Inc.
7270 Woodbine Avenue, Unit 307, Markham,
Ontario Canada L3R 4B9
MADE IN CHINA

Si vous avez la moindre question, veuillez contacter notre centre d'assistance à la clientèle, Nos coordonnées sont les suivantes:

 416-792-6088

 customerservice@aosom.ca

Importé par Aosom Canada Inc.
7270 Woodbine Avenue, unité 307,
Markham, Ontario Canada L3R 4B9
FABRIQUÉ EN CHINE

If you have any questions, please contact our customer care center, Our contact details are below:

UK

 0044-800-240-4004

 enquiries@mhstar.co.uk

IMPORTER ADDRESS:
MH STAR UK Ltd
1 Northampton Cross Logistics Park
Northampton Cross Road
Northampton
NN4 9FH
MADE IN CHINA

Si vous avez la moindre question, veuillez contacter notre centre d'assistance à la clientèle, Nos coordonnées sont les suivantes:

 0033-1-84166106

 aosom@mhfrance.fr

Importé par/Fabricant/REP:
MH FRANCE
2 Rue Maurice Hartmann
92130 Issy Les Moulineaux
France
FABRIQUÉ EN CHINE

Si tiene alguna pregunta, comuníquese con nuestro Centro de Atención al Cliente, Nuestros datos de contacto son los siguientes:

ES

 0034-931294512

 atencioncliente@aosom.es

IMPORTADOR/Fabricante/REP:
SPANISH AOSOM, S.L.
C/ROC GROS,Nº15.08550, ELS HOSTALET DE
BALENYÀ, SPAIN.
B66295775
HECHO EN CHINA

Se tiver alguma dúvida, por favor contacte o nosso Centro de Atendimento ao Cliente, Os nossos dados de contacto são os seguintes:

 0034-931294512

 info@aosom.pt.

IMPORTADOR/Fabricante/REP:
SPANISH AOSOM, S.L.
C.ROC GROS N.15, 08550. ELS HOSTALET DE
BALENYÀ
FEITO NA CHINA

In caso di dubbio, si prega di contattare il nostro centro assistenza clienti, I nostri dettagli di contatto sono di seguito:

IT

 0039-0249471447

 clienti@aosom.it

IMPORTATO DA/Produttore/REP:
AOSOM Italy srl
Centro Direzionale Milanofiori
Strada 1 Palazzo F1
20057 Assago (MI)
P.I.: 08567220960
FATTO IN CINA

Wenn Sie Fragen haben, wenden Sie sich bitte an unser Kundendienstzentrum, Unsere Kontaktdaten stehen unten:

DE

 0049-0(40)-87408465

 service@aosom.de

ADRESSE DES IMPORTEURE/Hersteller/REP:
MH Handel GmbH
Wendenstraße 309
D-20537 Hamburg
Germany
IN CHINA HERGESTELLT

Si vous avez la moindre question, veuillez contacter notre centre d'assistance à la clientèle, Nos coordonnées sont les suivantes:

FR

 0033-1-84166106

 aosom@mhfrance.fr

Importé par/Fabricant/REP:
MH FRANCE
2 Rue Maurice Hartmann
92130 Issy Les Moulineaux
France
FABRIQUÉ EN CHINE



FR

**DONNEZ
OU
RECYCLEZ**



ASSOCIATION

OU



LIVRAISON

OU



DÉCHÈTERIE

Adresses sur quefairedemesdechets.fr